



**HAL**  
open science

# Geometrical foundations of tensor calculus and relativity

Frédéric Schuller, Vincent Lorent

► **To cite this version:**

Frédéric Schuller, Vincent Lorent. Geometrical foundations of tensor calculus and relativity. DEA. université Paris 13, 2006. cel-00093001

**HAL Id: cel-00093001**

**<https://cel.hal.science/cel-00093001>**

Submitted on 12 Sep 2006

**HAL** is a multi-disciplinary open access archive for the deposit and dissemination of scientific research documents, whether they are published or not. The documents may come from teaching and research institutions in France or abroad, or from public or private research centers.

L'archive ouverte pluridisciplinaire **HAL**, est destinée au dépôt et à la diffusion de documents scientifiques de niveau recherche, publiés ou non, émanant des établissements d'enseignement et de recherche français ou étrangers, des laboratoires publics ou privés.

Institut Galilée

Université Paris 13



# Geometrical foundations of tensor calculus and relativity

lecture notes

*Frédéric Schuller & Vincent Lorent*

2006

*Der wichtigste Vergleichspunkt der Gauss'schen Flächentheorie und der allgemeinen Relativitätstheorie liegt in der Metrik, auf welche die Begriffe beider Theorien in der Hauptsache sich stützen.*

Albert Einstein 1922

*(The most important point of comparison of Gaussian surface theory and general relativity theory lies in the metric on which the notions of both theories essentially rely.)*

Most of this work is based on notes taken by F. S. during a lecture given by the late professor G. Bertram at the Polytechnical Institute in Hannover several decades ago. Lecture notes on general relativity issued by V. L. have also been used for completing the last chapter.

The authors are indebted to B. Oksengorn for a careful reading of the manuscript and corrections of numerous errors and misprints.

December 2006

## CONTENTS

Manifolds, particularly space curves; basic notions	1
The first groundform, the covariant metric tensor	11
The second groundform, Meusnier's theorem	19
Transformation groups in the plane	28
Co - and contravariant components for a special affine transformation in the plane	29
Surface vectors	32
Elements of tensor calculus	36
Generalization of the first groundform to the space	46
The covariant (absolute) derivation	57
Examples from elasticity theory	61
Geodesic lines	63
Main curvature, average and Gaussian curvature	67
Spherical image of a surface and third groundform	74
Parallel transport according to Levi - Civita; integrability conditions	76
Equations of Mainardi - Codazzi and Gauss	80
Remarks on non Euklidian geometries and special relativity theory	82
General relativity theory	88
Gravitational lensing and redshift	98
Exercises	102

## SPECIAL NOTATIONS

### gothic letters

1.) most vectors

2.) hyperbolic functions

### other notations

scalar product:  $(\mathfrak{u}, \mathfrak{v})$     $\mathfrak{u} \cdot \mathfrak{v}$    or  $\mathfrak{u} \mathfrak{v}$

vector product:  $[\mathfrak{u}, \mathfrak{v}]$

determinant:  $\langle \mathfrak{u}, \mathfrak{v}, \mathfrak{r} \rangle$  or  $|a_{kl}|$

$\mathfrak{A}, \mathfrak{a}$

$\mathfrak{Ä}, \mathfrak{ä}$

$\mathfrak{B}, \mathfrak{b}$

$\mathfrak{L}, \mathfrak{l}$

$\mathfrak{D}, \mathfrak{d}$

$\mathfrak{E}, \mathfrak{e}$

$\mathfrak{F}, \mathfrak{f}$

$\mathfrak{G}, \mathfrak{g}$

$\mathfrak{H}, \mathfrak{h}$

$\mathfrak{I}, \mathfrak{i}$

$\mathfrak{J}, \mathfrak{j}$

$\mathfrak{K}, \mathfrak{k}$

$\mathfrak{L}, \mathfrak{l}$

$\mathfrak{M}, \mathfrak{m}$

$\mathfrak{N}, \mathfrak{n}$

$\mathfrak{O}, \mathfrak{o}$

$\mathfrak{P}, \mathfrak{p}$

$\mathfrak{Q}, \mathfrak{q}$

$\mathfrak{R}, \mathfrak{r}$

$\mathfrak{S}, \mathfrak{s}, \mathfrak{1}$

$\mathfrak{T}, \mathfrak{t}$

$\mathfrak{U}, \mathfrak{u}$

$\mathfrak{V}, \mathfrak{v}$

$\mathfrak{W}, \mathfrak{w}$

$\mathfrak{X}, \mathfrak{x}$

$\mathfrak{Y}, \mathfrak{y}$

$\mathfrak{Z}, \mathfrak{z}$

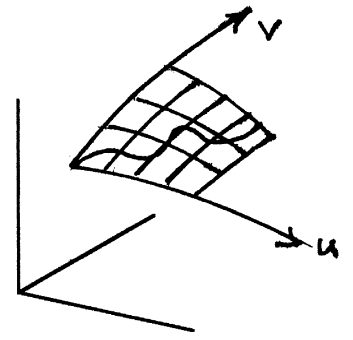

**I Initial grounds of surface theory**

§1 Manifolds, particularly space curves; basic notions

	explicit	implicit	parametric
plane curve	$y = f(x)$	$F(x,y) = 0$	$\mathcal{r}(t) = \begin{cases} x(t) \\ y(t) \end{cases}$
surface curve	$v = f(u)$	$F(u,v) = 0$	$\tilde{\mathcal{u}}(t) = \begin{cases} u(t) \\ v(t) \end{cases}$
space curve	$\begin{cases} z = f(x,y) \\ z = g(x,y) \end{cases}$	$\begin{cases} F(x,y,z) = 0 \\ G(x,y,z) = 0 \end{cases}$	$\mathcal{r}(t) = \begin{cases} x(t) \\ y(t) \\ z(t) \end{cases}$
space surface	$z = f(x,y)$	$F(x,y,z) = 0$	$\mathcal{r}(u,v) = \begin{cases} x(u,v) \\ y(u,v) \\ z(u,v) \end{cases}$
plane representation			
coord. transf.			$\begin{cases} x(u,v) \\ y(u,v) \end{cases}$
parameter transf.			$\begin{cases} \bar{u}(u,v) \\ \bar{v}(u,v) \end{cases}$
space repr.(euclidian)			
coord. point transf.			$\begin{cases} x(u,v,w) \\ y(u,v,w) \\ z(u,v,w) \end{cases}$
general			$\begin{cases} \bar{u}(u,v,w) \\ \bar{v}(u,v,w) \\ \bar{w}(u,v,w) \end{cases}$

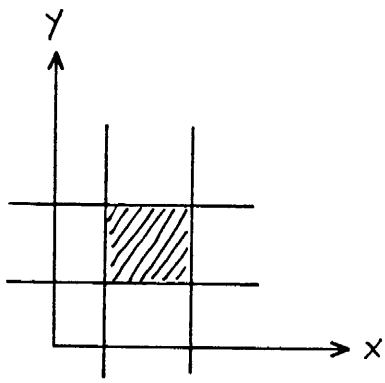

$$\begin{cases} u = f(x, y) \\ v = g(x, y) \end{cases}$$

$$\begin{cases} x = h(u, v) \\ y = k(u, v) \end{cases}$$

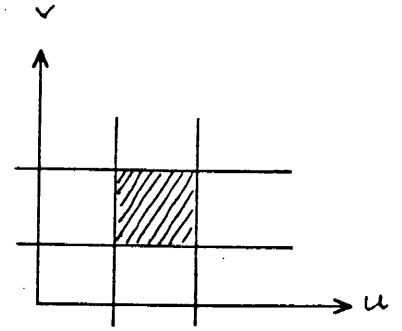
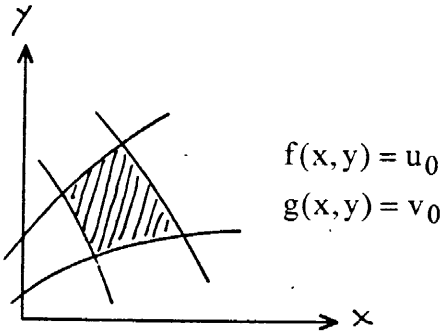
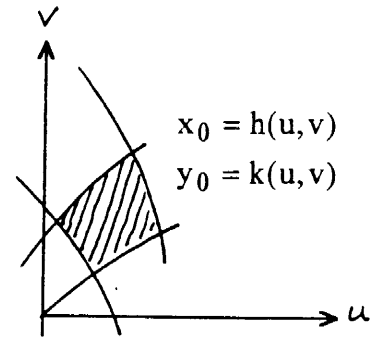

point transformation

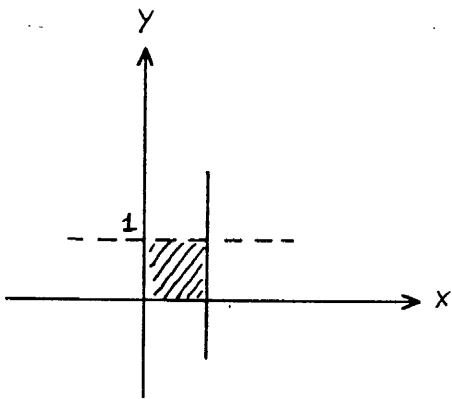

$$\begin{aligned} x &= r \cos \varphi \\ y &= r \sin \varphi \\ r &= \sqrt{x^2 + y^2} \\ \varphi &= \text{arccotg} \frac{x}{y} \end{aligned}$$

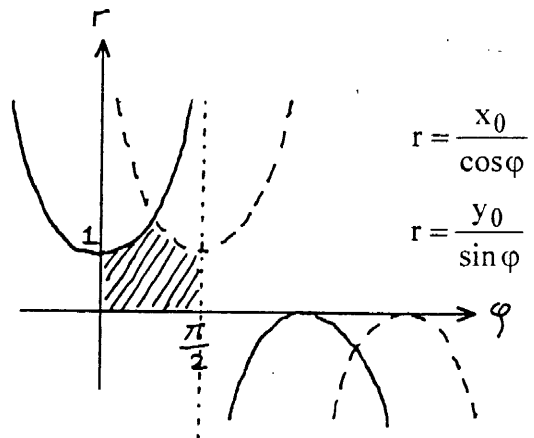

$$\begin{aligned} r &= \frac{x_0}{\cos \varphi} \\ r &= \frac{y_0}{\sin \varphi} \end{aligned}$$

Coord. Transformation

Coord. Transformation

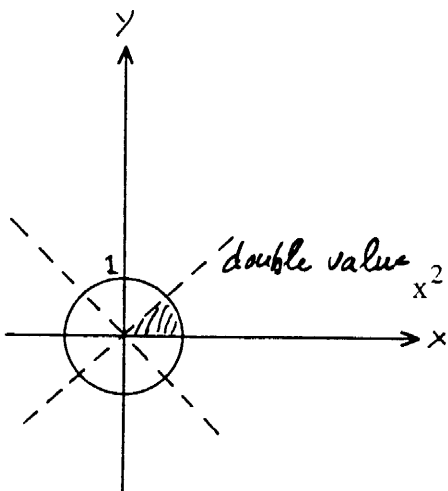

$$\begin{aligned} y &= \sqrt{r_0^2 - x^2} \\ y &= x \text{tg} \varphi_0 \end{aligned}$$

double values  $x^2 + y^2 = r^2 \left| \pm \sqrt{\dots} \right.$

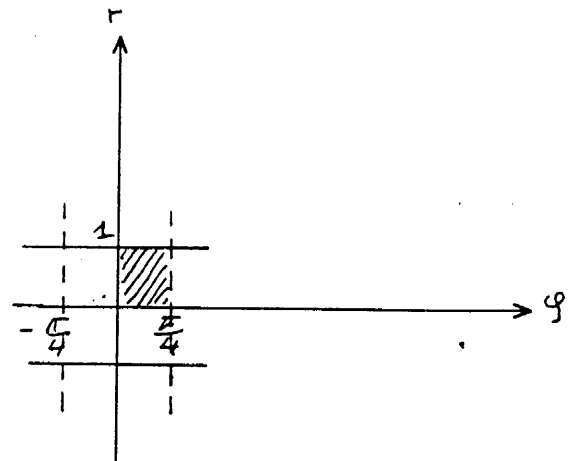

point transformation

$$e^{xyz} - \frac{xy}{z} = 0 \quad F(x,y,z) = 0 \rightarrow \mathcal{U}(u,v)$$

$$\text{trial: } x=u \quad y=f(u,v) \quad z=g(u,v)$$

$$\left. \begin{array}{l} x \cdot y \cdot z = u \cdot f \cdot g = \ln h(u,v) \\ \frac{x \cdot y}{z} = \frac{u \cdot f}{g} = h(u,v) \end{array} \right\} h = v \text{ searched}$$

$$\left. \begin{array}{l} u \cdot f \cdot g = \ln v \\ u \cdot \frac{f}{g} = v \end{array} \right\} f = \frac{\sqrt{v \ln v}}{u} \quad g = \sqrt{\frac{\ln v}{v}}$$

$$\mathcal{U}(u,v) = \begin{cases} x = u \\ y = \frac{1}{u} \sqrt{v \ln v} \\ z = \sqrt{\frac{\ln v}{v}} \end{cases}$$

**EX1** Search the largest possible classes  $F(x,y,z)$  with the property that these functions cannot be solved explicitly for one variable but can be cast in the form  $\mathcal{U}(u,v)$ .

$$F(x,y,z) = 0 \rightarrow \mathcal{U}(u,v)$$

**EX2**  $\begin{matrix} x = u + v \\ y = v \end{matrix}$  to be interpreted on one hand as point- on the other as coordinate

transformation. Into what domain evolves the unit square?

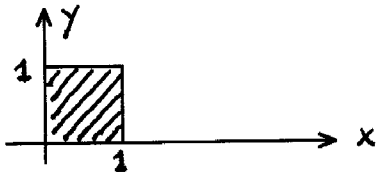

$$x = x^1 \quad u = u^1$$

$$y = x^2 \quad v = u^2 \quad x^i (u^k) \quad (u,v) \quad (x^2)^2 \text{ power}$$

$$z = x^3 \quad w = u^3$$

$\bar{u}^i (u^k)$  Representation of a space on itself. (Difference between coordinate and parameter transformation not yet to be seized here).



Spacecurves

$$\mathcal{r}(t) = \begin{cases} x(t) \\ y(t) \\ z(t) \end{cases} \quad \frac{d}{dt} = \bullet \quad \frac{d}{ds} = \prime$$

$$s(t) = \int \sqrt{d\mathcal{r}^2} = \int_{t_0}^t \sqrt{\dot{\mathcal{r}}^2} dt \quad \begin{matrix} +\sqrt{\phantom{x}} & s, t \text{ same sens} \\ -\sqrt{\phantom{x}} & s, t \text{ opposite sens} \end{matrix}$$

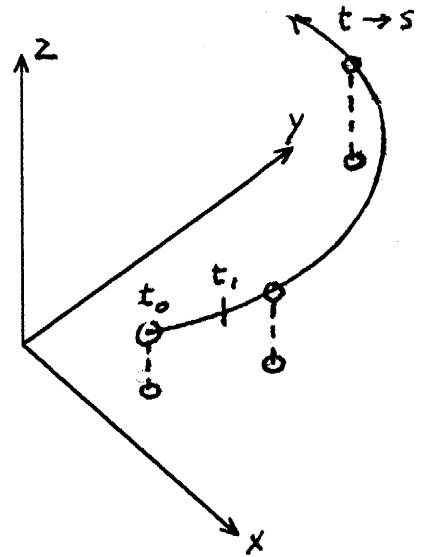

Differential invariant; geometrical properties

Parameterinvariants: (quantities which do not change when passing from one parametersystem to an other)

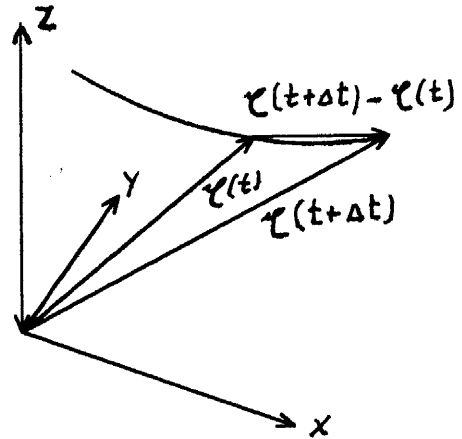
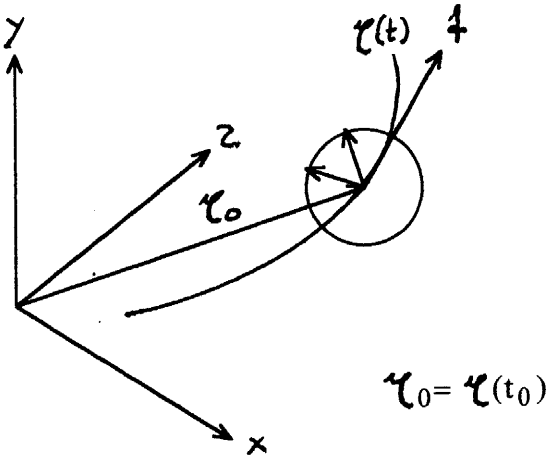

curves and surfaces smooth  
(continuous and continuously derivable)

velocity

$$\mathcal{r}(t) \rightarrow \dot{\mathcal{r}}(t) = \begin{cases} \dot{x}(t) \\ \dot{y}(t) \\ \dot{z}(t) \end{cases}$$

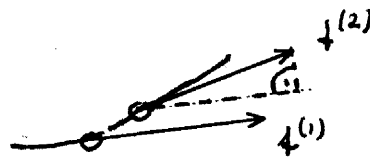

1. Tangentvector

$$t = \mathcal{r}' = \frac{\dot{\mathcal{r}}}{\sqrt{\dot{\mathcal{r}}^2}} \quad \text{property} \quad |t| = 1 = \sqrt{t'^2}$$

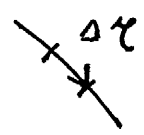

$$\left. \begin{matrix} \mathcal{r}' \sim \dot{\mathcal{r}} \\ \mathcal{r}'' \sim \ddot{\mathcal{r}} \\ [\mathcal{r}' \mathcal{r}''] \sim [\dot{\mathcal{r}} \ddot{\mathcal{r}}] \end{matrix} \right\} \begin{cases} \mathcal{r}' = \frac{\dot{\mathcal{r}}}{|\dot{\mathcal{r}}|}, \quad \mathcal{r}'' = \left( \frac{\dot{\mathcal{r}}}{|\dot{\mathcal{r}}|} \right)' \cdot \frac{1}{|\dot{\mathcal{r}}|} = \frac{\ddot{\mathcal{r}}}{|\dot{\mathcal{r}}|^2} + (\dots) \dot{\mathcal{r}} \\ \mathcal{r}''' = \left( \frac{\ddot{\mathcal{r}}}{|\dot{\mathcal{r}}|^2} - \frac{(\dot{\mathcal{r}} \ddot{\mathcal{r}})}{|\dot{\mathcal{r}}|^4} \dot{\mathcal{r}} \right)' \cdot \frac{1}{|\dot{\mathcal{r}}|} = \frac{\dddot{\mathcal{r}}}{|\dot{\mathcal{r}}|^3} + (\dots) \ddot{\mathcal{r}} + (\dots) \dot{\mathcal{r}} \end{cases}$$

2. Main normal vector

$$f = \rho \cdot \epsilon'' = \rho \left( \frac{\ddot{\epsilon}}{|\dot{\epsilon}|^2} - \frac{\dot{\epsilon} \ddot{\epsilon}}{|\dot{\epsilon}|^4} \epsilon \right)$$

$$t^2 = 1$$

$$2 t t' = 0$$

$$\kappa = \frac{1}{\rho} = \left| \frac{d\alpha}{ds} \right|$$

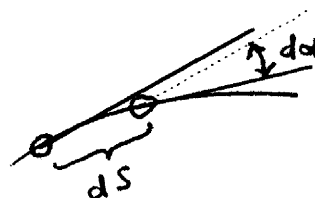

Property:

$$1.) |f| = \rho |\epsilon''| = \rho |t'| = \rho \left| \frac{d t}{ds} \right| = \rho \left| \frac{d\alpha}{ds} \right| = 1$$

$$f \cdot t = \rho (\epsilon'' \cdot \epsilon') = \rho \left( \frac{\epsilon' \cdot \ddot{\epsilon}}{|\dot{\epsilon}|^2} \right) = \rho \left( \frac{1}{2} \right)' = 0 \rightarrow f \perp t$$

3. Binormal vector direction of  $[\dot{\epsilon} \ddot{\epsilon}]$

$$b = [t f] = \rho [\epsilon' \epsilon''] = \frac{[\dot{\epsilon} \ddot{\epsilon}]}{\sqrt{[\dot{\epsilon} \ddot{\epsilon}]^2}}$$

Identity of Lagrange:  $[\dot{\epsilon} \ddot{\epsilon}]^2 = \dot{\epsilon}^2 \ddot{\epsilon}^2 (1 - \cos^2(\angle(\dot{\epsilon}, \ddot{\epsilon}))) = \dot{\epsilon}^2 \ddot{\epsilon}^2 - (\dot{\epsilon} \ddot{\epsilon})^2$

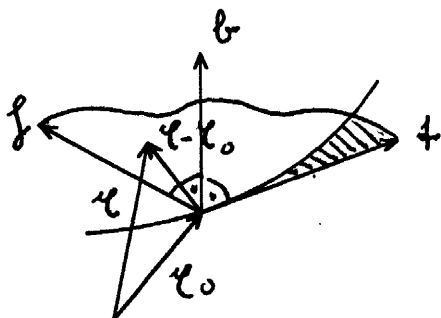

4. Planes

from  $f, t$  osculatory plane in  $\epsilon_0$   $\langle \epsilon - \epsilon_0, \dot{\epsilon}_0, \ddot{\epsilon}_0 \rangle = 0$

from  $b, f$  normal plane in  $\epsilon_0$   $\langle \epsilon - \epsilon_0, \dot{\epsilon}_0 \rangle = 0$

from  $t, b$  rectifying plane in  $\epsilon_0$   $\langle \epsilon - \epsilon_0, (\dot{\epsilon} \dot{\epsilon})^2 \ddot{\epsilon} - (\dot{\epsilon} \ddot{\epsilon}) \dot{\epsilon} \rangle = 0$

5. curvature (always  $\geq 0$ )

$$\kappa(t) = \frac{1}{\rho} = |[\epsilon' \epsilon'']| = \left| \left[ \frac{\dot{\epsilon}}{|\dot{\epsilon}|}, \frac{1}{|\dot{\epsilon}|^2} \ddot{\epsilon} - \frac{\dot{\epsilon} \ddot{\epsilon}}{|\dot{\epsilon}|^4} \epsilon \right] \right| = \frac{|[\dot{\epsilon} \ddot{\epsilon}]|}{|\dot{\epsilon}|^3} = \frac{\sqrt{\dot{\epsilon}^2 \ddot{\epsilon}^2 - (\dot{\epsilon} \ddot{\epsilon})^2}}{\sqrt{\dot{\epsilon}^2}^3}$$

= 0

6. Torsion

Preliminary remark: 1.)  $t' = \epsilon'' = \kappa f$  1st Frenet's formula

$$t' \parallel f$$

2.)  $b' = [t f]' = [t' f] + [t f'] = [\kappa f, \tau b + \sigma t] = \tau [t b] = -\tau f$  3d. Frenet's formula

$\tau(t) = -b' \cdot f$  torsion

$$\kappa(t) = \frac{1}{\rho(t)} = \frac{||\mathbf{r}' \mathbf{r}''||}{|\dot{\mathbf{c}}|^3}$$

$$1.) \quad \mathbf{t}' = \kappa \mathbf{f} \quad \mathbf{b} = \rho[\mathbf{r}' \mathbf{r}'']$$

$$3.) \quad \mathbf{b}' = -\tau \mathbf{f} \quad |: \mathbf{f} \quad |\mathbf{b}'| = |\tau| \quad \mathbf{f} = \rho \mathbf{r}''$$

$$\tau(t) = -\mathbf{b}' \cdot \mathbf{f} = -(\underbrace{\rho'[\mathbf{r}' \mathbf{r}'']}_{\sim \mathbf{b}} + \underbrace{\rho[\mathbf{r}'' \mathbf{r}'']}_{=0} + \underbrace{\rho[\mathbf{r}' \mathbf{r}''']}_{\sim \mathbf{f}}) \cdot \rho \mathbf{r}''$$

$$= \rho^2 \langle \mathbf{r}' \mathbf{r}'' \mathbf{r}''' \rangle \quad [\mathbf{r}' \mathbf{r}'''] = -[\mathbf{r}''' \mathbf{r}']$$

$$= \frac{|\dot{\mathbf{c}}|^6}{[\dot{\mathbf{c}} \ddot{\mathbf{c}}]^2} \left\langle \frac{\dot{\mathbf{c}}}{|\dot{\mathbf{c}}|}, \frac{\ddot{\mathbf{c}}}{|\dot{\mathbf{c}}|^2} + (\dots) \frac{\dot{\mathbf{c}}}{|\dot{\mathbf{c}}|}, \frac{\ddot{\mathbf{c}}}{|\dot{\mathbf{c}}|^3} + (\dots) \ddot{\mathbf{c}} + (\dots) \dot{\mathbf{c}} \right\rangle$$

$$\boxed{\tau(t) = \frac{\langle \dot{\mathbf{c}} \ddot{\mathbf{c}} \ddot{\mathbf{c}} \rangle}{[\dot{\mathbf{c}} \ddot{\mathbf{c}}]^2}} \quad \text{3th differential invariant}$$

1.) linear combination

$$\mathbf{f}' = \alpha \mathbf{t} + \beta \mathbf{b} \quad | \cdot \textcircled{1} \mathbf{t} \quad \textcircled{2} \mathbf{b}$$

$$\alpha = \mathbf{f}' \cdot \mathbf{t} = -\mathbf{f} \cdot \mathbf{t}' = -\kappa(\mathbf{f}, \mathbf{f}) = -\kappa$$

$$\beta = \mathbf{f}' \cdot \mathbf{b} = -\mathbf{f} \cdot \mathbf{b}' = \tau(\mathbf{f}, \mathbf{f}) = \tau$$

$$2.) \quad \mathbf{f}' = -\kappa \mathbf{t} + \tau \mathbf{b}$$

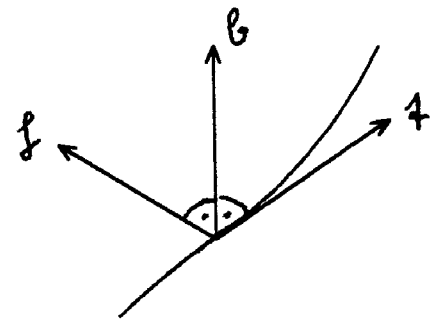

$$(\mathbf{f} \mathbf{t})' = \mathbf{f}' \mathbf{t} + \mathbf{f} \mathbf{t}' = 0$$

$$\boxed{\begin{aligned} \mathbf{t}' &= \kappa \mathbf{f} \\ \mathbf{f}' &= -\kappa \mathbf{t} + \tau \mathbf{b} \\ \mathbf{b}' &= -\tau \mathbf{f} \end{aligned}}$$

Frenet's formulae (derivative equations of spacecurve theory)

$$\begin{cases} s(t) \\ \kappa(t) \\ \tau(t) \end{cases} \quad \text{complete invariant system}$$

These three quantities determine completely the shape of the spacecurve. Proof: one substitutes  $s(t)$  etc into Frenet's formulae; this yields a system of differential equations. Darboux shows that it can be reduced to Riccati differential equations.

Space surfaces

$$\dot{\mathcal{r}}(u,v) = \frac{d}{dt} = \frac{d}{ds}$$

$$\begin{cases} u(t) \\ v(t) \end{cases} \quad \mathcal{r}(u(t), v(t)) = x^i(u^j(t))$$

$i = 1, 2, 3$   
 $j = 1, 2$

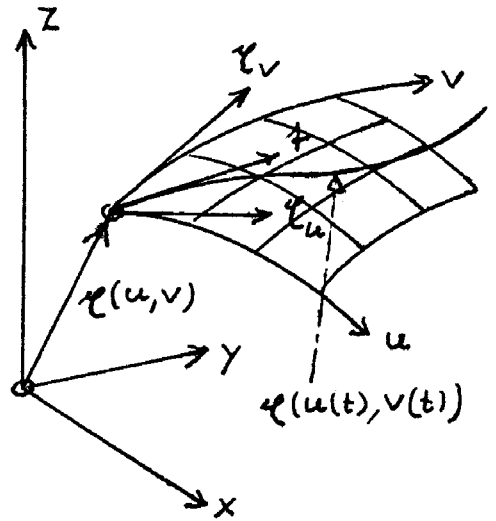

1.) velocity

$$\dot{\mathcal{r}} = \mathcal{r}_u \dot{u} + \mathcal{r}_v \dot{v} = \frac{\partial x^i}{\partial u^j} \frac{du^j}{dt} = \frac{\partial x^i}{\partial u^1} \frac{du^1}{dt} + \frac{\partial x^i}{\partial u^2} \frac{du^2}{dt}$$

*Einstein's summation prescription*

1)  $u^k u^k = \sum_{k=1}^2 (u^k)^2 = u^1 u^1 + u^2 u^2$

2)  $u^k + u^k (u^k)^2 = u^k + \sum (u^k)^3$

3)  $u^k + u^k u^k u^k = u^k + (u^k)^3$

$$\begin{matrix} x^1 = x & u^1 = u \\ x^2 = y & u^2 = v \\ x^3 = z & \end{matrix}$$

$$\begin{matrix} \mathcal{r}_u = \mathcal{r}_1 \\ \mathcal{r}_v = \mathcal{r}_2 \end{matrix}$$

1,2 differentiation indices

$$\dot{\mathcal{r}} = \mathcal{r}_1 \dot{u}^1 + \mathcal{r}_2 \dot{u}^2 = \mathcal{r}_i \dot{u}^i = \mathcal{r}_k \dot{u}^k$$

2.) tangent vector

$$\mathcal{r}' = \mathcal{r}_u \cdot u' + \mathcal{r}_v \cdot v' = \mathcal{r}_i \cdot u^i$$

$$|\mathcal{r}'| = \left| \frac{d\mathcal{r}}{ds} \right| = \left| \frac{ds}{ds} \right| = 1$$

3.) tangent vector of coordinate lines

$$\begin{matrix} \mathcal{r}_u & \mathcal{r}_v \\ \frac{\partial x^i}{\partial u^1} & \text{respectively} & \frac{\partial x^i}{\partial u^2} \end{matrix}$$

$$|\mathcal{r}_u| \neq 1 \text{ in general}$$

3a.) norm  $\frac{\mathcal{r}_u}{|\mathcal{r}_u|}$  ;  $\frac{\mathcal{r}_v}{|\mathcal{r}_v|}$

4.) Surface normal vector

$$[\boldsymbol{r}_u \boldsymbol{r}_v]$$

normalized

$$\boldsymbol{n} = \frac{[\boldsymbol{r}_u \boldsymbol{r}_v]}{\|[\boldsymbol{r}_u \boldsymbol{r}_v]\|} = \boldsymbol{v}_i$$

$$= \frac{[\boldsymbol{r}_u \boldsymbol{r}_v]}{\sqrt{\underbrace{\boldsymbol{r}_u^2}_{g_{11}} \underbrace{\boldsymbol{r}_v^2}_{g_{22}} - \underbrace{(\boldsymbol{r}_u \boldsymbol{r}_v)^2}_{g_{12} = g_{21}}}} = \frac{1}{\sqrt{g}} [\boldsymbol{r}_u \boldsymbol{r}_v]$$

EX3  $\boldsymbol{s}(t) = (\sin t, -\sqrt{1-t^2}, \cos t)$

draw sketch  $\boldsymbol{s}(t), \boldsymbol{\kappa}(t), \boldsymbol{\tau}(t)$   $t=0$

$$\frac{[\mathbf{r}_u \mathbf{r}_v]}{\|\mathbf{r}_u \mathbf{r}_v\|} = \frac{[\mathbf{r}_u \mathbf{r}_v]}{\sqrt{\underbrace{\mathbf{r}_u^2}_{g_{11}} \underbrace{\mathbf{r}_v^2}_{g_{22}} - \underbrace{(\mathbf{r}_u \mathbf{r}_v)^2}_{g_{12}}}}$$

$$g_{ik} = \begin{pmatrix} E = g_{11} = \mathbf{r}_u^2 & F = g_{12} = \mathbf{r}_u \mathbf{r}_v \\ F = g_{21} = \mathbf{r}_v \mathbf{r}_u & G = g_{22} = \mathbf{r}_v^2 \end{pmatrix} \quad g_{ik} = \mathbf{r}_i \mathbf{r}_k$$

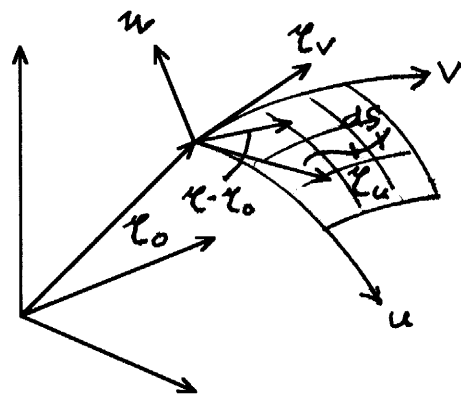

5.) tangent plane in  $\mathbf{r}_0$  :  $\langle \mathbf{r} - \mathbf{r}_0, \mathbf{r}_u, \mathbf{r}_v \rangle = 0$

### Measurements on curved surfaces

1.) lengths

$$\begin{aligned} l &= ds^2 = (d\mathbf{r}, d\mathbf{r}) = (\mathbf{r}_u du + \mathbf{r}_v dv, \mathbf{r}_u du + \mathbf{r}_v dv) \\ &= \mathbf{r}_u^2 du^2 + 2\mathbf{r}_u \mathbf{r}_v dudv + \mathbf{r}_v^2 dv^2 \\ &= g_{11}(u, v) du^2 + 2g_{12}(u, v) dudv + g_{22}(u, v) dv^2 = g_{ik} du^i du^k \\ u &= u^1 \quad v = u^2 \end{aligned}$$

1st groundform of surface theory

quadratic form proves to be positive definite

$$s = \int \sqrt{g_{ik} du^i du^k} = \int_{t_0}^t \sqrt{g_{ik}(u^j(t)) u^i u^k} dt \quad g = g_{11}g_{22} - g_{12}^2 = \begin{vmatrix} g_{11} & g_{12} \\ g_{21} & g_{22} \end{vmatrix}$$

$$g_{ik} u^i u^k = \frac{ds^2}{ds^2} = 1$$

2.) surfaces

$$dF = \|\mathbf{d}\mathbf{r}_u \mathbf{d}\mathbf{r}_v\| = \|\mathbf{r}_u du, \mathbf{r}_v dv\| = \sqrt{\underbrace{\mathbf{r}_u^2}_{g_{11}} \underbrace{\mathbf{r}_v^2}_{g_{22}} - \underbrace{(\mathbf{r}_u \mathbf{r}_v)^2}_{g_{12}}} dudv = \sqrt{g} dudv$$

g has to be positive

$$F = \iint_{\mathcal{L}} \sqrt{g} dudv$$

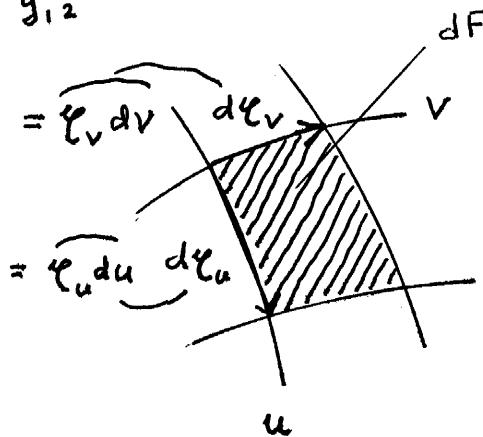

3.) angles

$$\circ = \frac{d}{d\tau}$$

$$\cos(\dot{\mathbf{r}}, \dot{\mathbf{r}}) = \frac{\dot{\mathbf{r}} \cdot \dot{\mathbf{r}}}{|\dot{\mathbf{r}}| |\dot{\mathbf{r}}|} = \frac{(\mathcal{L}_u \dot{u} + \mathcal{L}_v \dot{v})(\mathcal{L}_u \ddot{u} + \mathcal{L}_v \ddot{v})}{\sqrt{(\mathcal{L}_u \dot{u} + \mathcal{L}_v \dot{v})^2} \sqrt{(\mathcal{L}_u \ddot{u} + \mathcal{L}_v \ddot{v})^2}} = \frac{g_{11} \ddot{u} + g_{12} (\dot{u} \ddot{v} + \dot{v} \ddot{u}) + g_{22} \ddot{v}}{\sqrt{g_{11} \dot{u}^2 + 2g_{12} \dot{u} \dot{v} + g_{22} \dot{v}^2} \sqrt{g_{11} \ddot{u}^2 + 2g_{12} \ddot{u} \ddot{v} + g_{22} \ddot{v}^2}}$$

$$\cos \dot{\mathbf{r}} \dot{\mathbf{r}} = \frac{g_{ik} \dot{u}^i \dot{u}^k}{\sqrt{g_{ik} \dot{u}^i \dot{u}^k} \sqrt{g_{ik} \ddot{u}^i \ddot{u}^k}}$$

$$\dot{\mathbf{r}} = \mathcal{L}_u \quad \ddot{\mathbf{r}} = \mathcal{L}_v$$

special case  $\dot{u}=1, \dot{v}=0$   
 $\ddot{u}=0, \ddot{v}=1$

if parameters  $t$  and  $\tau$  are identical with  $u$  and  $v$ ;  $t=u \quad \tau=v$

$$\cos \mathcal{L}_u \mathcal{L}_v = \frac{g_{12}}{\sqrt{g_{11} g_{22}}}$$

orthogonal parameternet:  $g_{12} = 0$

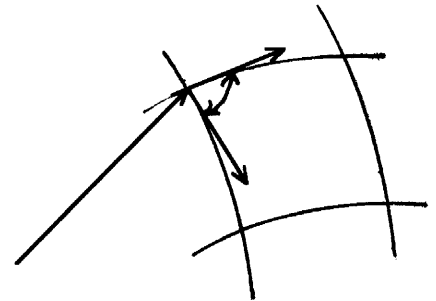
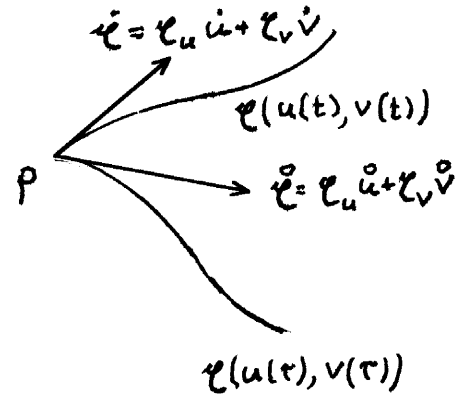

§2. The first groundform, the covariant metric tensor

$$I = ds^2 = (dx^1)^2 + (dx^2)^2 + (dx^3)^2$$

$$= \left( \frac{\partial x^1}{\partial u^1} du^1 + \frac{\partial x^1}{\partial u^2} du^2 \right)^2 + (\dots)^2 + (\dots)^2$$

$$= \underbrace{\left[ \left( \frac{\partial x^1}{\partial u^1} \right)^2 + \left( \frac{\partial x^2}{\partial u^1} \right)^2 + \left( \frac{\partial x^3}{\partial u^1} \right)^2 \right]}_{E = g_{11}} (du^1)^2$$

$$+ 2 \underbrace{\left[ \frac{\partial x^1}{\partial u^1} \frac{\partial x^1}{\partial u^2} + \frac{\partial x^2}{\partial u^1} \frac{\partial x^2}{\partial u^2} + \frac{\partial x^3}{\partial u^1} \frac{\partial x^3}{\partial u^2} \right]}_{F = g_{12} = g_{21}} du^1 du^2$$

$$+ \underbrace{\left[ \left( \frac{\partial x^1}{\partial u^2} \right)^2 + \left( \frac{\partial x^2}{\partial u^2} \right)^2 + \left( \frac{\partial x^3}{\partial u^2} \right)^2 \right]}_{G = g_{22}} (du^2)^2 = \sum_{ik} g_{ik} du^i du^k = g_{ik} du^i du^k$$

$$= Edu^2 + 2Fdudv + Gdv^2$$

$$ds^2 = dx^j dx^j; \quad dx^j dx^j = \frac{\partial x^j}{\partial u^i} du^i \cdot \frac{\partial x^j}{\partial u^k} du^k = \frac{\partial x^j}{\partial u^i} \cdot \frac{\partial x^j}{\partial u^k} du^i du^k$$

$$g_{ik} = g_{ki}$$

## Examples

1.) Catenoid  $x^3 = \cosh x^1$  rotating

$\mathcal{r}$	$\mathcal{r}_u$	$\mathcal{r}_v$
u	1	0
$\cosh u \sin v$	$\sinh u \sin v$	$\cosh u \cos v$
$\cosh u \cos v$	$\sinh u \cos v$	$\cosh u (-\sin v)$

orthogonal parameterlines

$$(g_{ik}) = \begin{pmatrix} \mathcal{r}_u^2 & \mathcal{r}_u \mathcal{r}_v \\ \mathcal{r}_u \mathcal{r}_v & \mathcal{r}_v^2 \end{pmatrix} = \begin{pmatrix} \cosh^2 u & 0 \\ 0 & \cosh^2 u \end{pmatrix} \quad ds^2 = \cosh^2 u (du^2 + dv^2)$$

$$g = \cosh^4 u$$



$ds^2 = F(u,v)(du^2 + dv^2)$	isotherm parameters	infinitesimal squares
$ds^2 = F(u,v)(f(u)du^2 + g(v)dv^2)$	isometric parameters	infinitesimal rectangles

2.) winding surface

$\mathcal{r}$	$\mathcal{r}_u$	$\mathcal{r}_v$
$u \cos v$	$\cos v$	$-u \sin v$
$u \sin v$	$\sin v$	$u \cos v$
$v$	$0$	$1$

$$ds^2 = du^2 + \overbrace{[u^2 + 1]}^U dv^2 \quad \text{isometric parameters}$$

$$= U(u) \left[ \frac{1}{U(u)} du^2 + dv^2 \right]$$

$$(g_{ik}) = \begin{pmatrix} 1 & 0 \\ 0 & u^2 + 1 \end{pmatrix} \quad g = u^2 + 1$$

parameter transformation, see following pages

$$\psi = \sin u$$

$\mathcal{r}$	$\mathcal{r}_u$	$\mathcal{r}_v$
$\psi(u) \cos v$		
$\psi(u) \sin v$		
$v$		

$$ds^2 = dx^j dx^j = \frac{\partial x^j}{\partial u^i} du^i \frac{\partial x^j}{\partial u^k} du^k = \frac{\partial x^j}{\partial u^i} \frac{\partial x^j}{\partial u^k} du^i du^k$$

(d $\zeta$  d $\zeta$ )  $g_{ik} = \zeta_i \zeta_k$

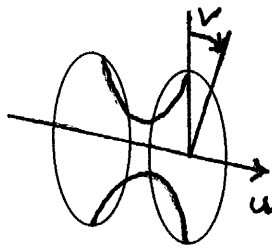

	$\zeta$	$\zeta_u$	$\zeta_v$
u	$ u  \cos v$		
v	$ u  \sin v$		

$$g_{ik} = \begin{pmatrix} |u|^2 & 0 \\ 0 & |u|^2 \end{pmatrix}$$

$g = |u|^4 u$

$$I = ds^2 = |u|^2 (du^2 + dv^2)$$

$$ds^2 = F(u, v)(du^2 + dv^2)$$

$$ds^2 = F(u, v)(f(u)du^2 + g(v)dv^2)$$

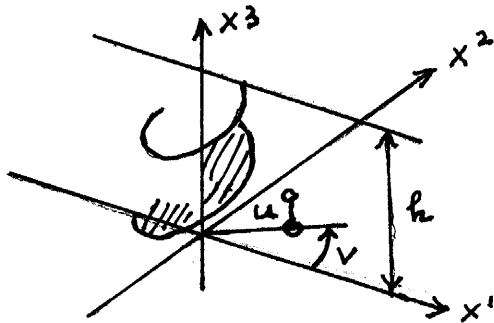

$\zeta$	$\zeta_u$	$\zeta_v$
$u \cos v$	$\cos v$	$-u \sin v$
$u \sin v$	$\sin v$	$u \cos v$
$v \cdot \frac{h}{2\pi}$	$0$	$\frac{h}{2\pi}$

$$(g_{ik}) = \begin{pmatrix} 1 & 0 \\ 0 & u^2 + \left(\frac{h}{2\pi}\right)^2 \end{pmatrix}$$

$$ds^2 = du^2 + \underbrace{\left[ u^2 + \left(\frac{h}{2\pi}\right)^2 \right]}_{U(u)} dv^2 = U \left\{ \frac{1}{U} du^2 + dv^2 \right\} \text{ isometric parameters}$$

special case:  $h = 0 \rightarrow u = r \quad v = \varphi \quad ds^2 = dr^2 + r^2 d\varphi^2$

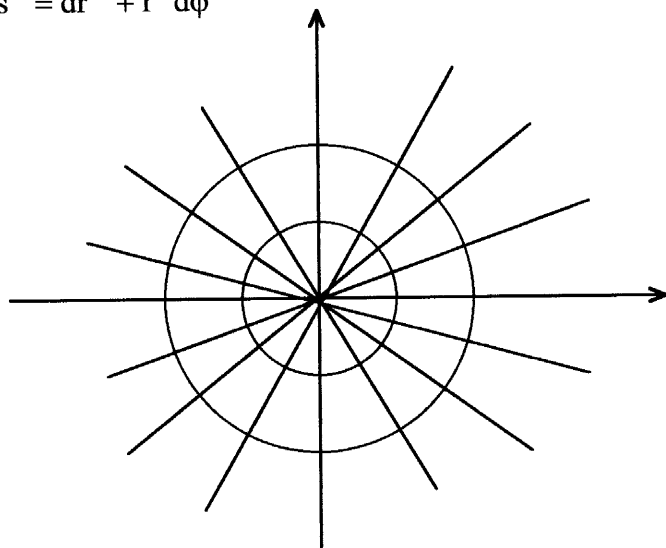

Singularities of parameterlines

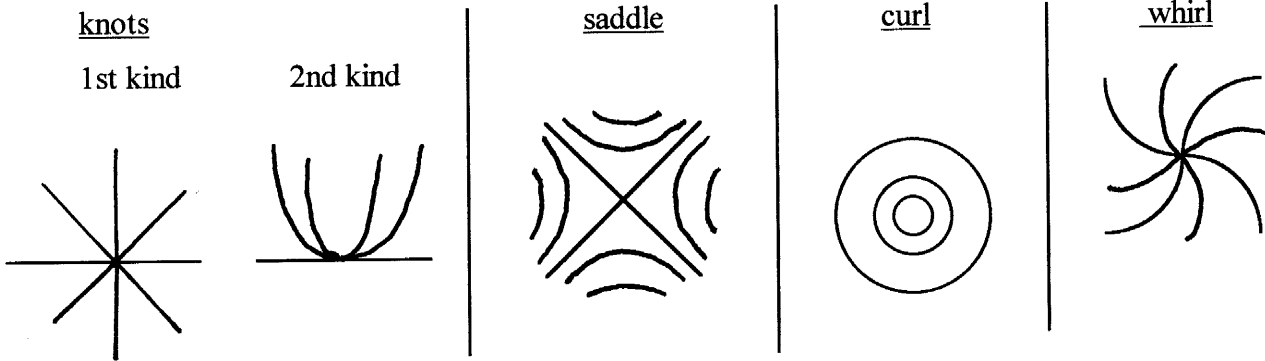

winding surface: transformation into isotherm parameters

$\tau$	$\tau_u$	$\tau_v$
$\psi(u) \cos v$	$\psi' \cos v$	$-\psi \sin v$
$\psi(u) \sin v$	$\psi' \sin v$	$\psi \cos v$
$v \frac{h}{2\pi}$	0	$\frac{h}{2\pi}$

$$g_{ik} = \begin{pmatrix} \psi'^2 & 0 \\ 0 & \psi^2 + \left(\frac{h}{2\pi}\right)^2 \end{pmatrix}$$

$$ds^2 = \psi'^2 du^2 + \left[ \psi^2 + \left(\frac{h}{2\pi}\right)^2 \right] dv^2$$

$$\psi'^2 = \psi^2 + \left(\frac{h}{2\pi}\right)^2 \text{ e.g. } \psi = \frac{h}{2\pi} \sin u \quad \psi'^2 = \left(\frac{h}{2\pi}\right)^2 \cos^2 u$$

$\tau$

---

$$\frac{h}{2\pi} \sin u \cos v$$

$$\frac{h}{2\pi} \sin u \sin v$$

$$\frac{h}{2\pi} v$$

$$ds^2 = \left(\frac{h}{2\pi}\right)^2 \cos^2 u (du^2 + dv^2) \text{ for } h = 2\pi \text{ cf. Catenoid}$$

in both cases same 1st groundform: length conserving representation

If there exists a continuous suite of intermediate surfaces possessing the same 1st groundform:

large scale developability

EX4 1. groundform

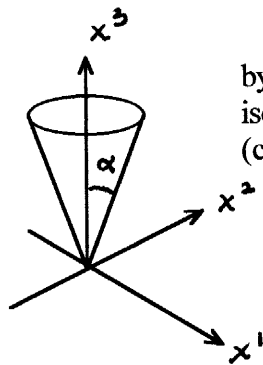
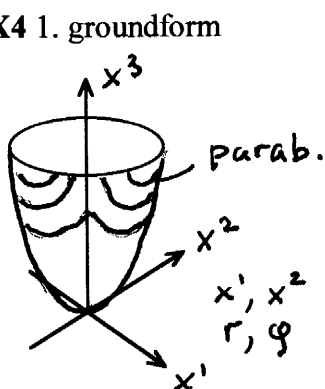

by transformation  
isotherm parameters  
(cylindercoordinates)

## Developability

developing a surface on a plane = representing it length conserving

## 1) Cylinder

$\mathcal{r}$	$\mathcal{r}_u$	$\mathcal{r}_v$	
$\rho \cos u$	$-\rho \sin u$	0	$g_{11} = \rho^2 \quad g_{12} = g_{21} = 0 \quad g_{22} = 1$
$\rho \sin u$	$\rho \cos u$	0	
$v$	0	1	

$$ds^2 = \rho^2 du^2 + dv^2$$

developed on the plane:  $\mathcal{r} = \begin{pmatrix} x \\ y \end{pmatrix}$

$\mathcal{r}$	$\mathcal{r}_u$	$\mathcal{r}_v$	
$\rho u$	$\rho$	0	$g_{11} = \rho^2 \quad g_{12} = g_{21} = 0 \quad g_{22} = 1$
$v$	0	1	

$$ds^2 = \rho^2 du^2 + dv^2$$

## II) Cone

$\mathcal{r}$	$\mathcal{r}_u$	$\mathcal{r}_v$	
$u \cos v$	$\cos v$	$-u \sin v$	$g_{11} = 1 + \frac{u^2}{\sin^2 \alpha} \quad g_{12} = g_{21} = 0 \quad g_{22} = u^2$
$u \sin v$	$\sin v$	$u \cos v$	
$ctg \alpha \cdot u$	$ctg \alpha$	0	

$$ds^2 = \frac{1}{\sin^2 \alpha} du^2 + u^2 dv^2$$

developed on the plane:  $\mathcal{r} = \begin{pmatrix} x \\ y \end{pmatrix}$

$\mathcal{r}$	$\mathcal{r}_u$	$\mathcal{r}_v$
$\frac{1}{\sin \alpha} u \cos(\sin \alpha \cdot v)$	$\frac{1}{\sin \alpha} \cos(\sin \alpha \cdot v)$	$-u \sin(\sin \alpha \cdot v)$
$\frac{1}{\sin \alpha} u \sin(\sin \alpha \cdot v)$	$\frac{1}{\sin \alpha} \sin(\sin \alpha \cdot v)$	$u \cos(\sin \alpha \cdot v)$

$$g_{11} = \frac{1}{\sin^2 \alpha} \quad g_{12} = g_{21} = 0 \quad g_{22} = u^2$$

$$ds^2 = \frac{1}{\sin^2 \alpha} du^2 + u^2 dv^2$$

$$x^2 + y^2 = \frac{u^2}{\sin^2 \alpha}$$

for  $u = \text{const}$  concentric circles with radius  $\frac{u}{\sin \alpha}$

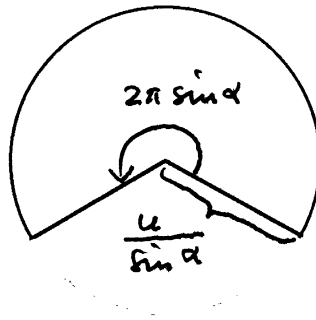
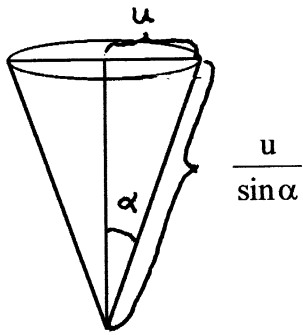

$\alpha = 30^\circ$  half disc

$$ds^2 = g_{11} du^2 + 2g_{12} dudv + g_{22} dv^2$$

$$= \frac{1}{g_{11}} \left\{ (g_{11} du + g_{12} dv)^2 + g dv^2 \right\} \geq 0$$

$$g = g_{11}g_{22} - g_{12}^2$$

$$g_{12} = g_{21}$$

$$\boxed{g > 0 \text{ therefore } g_{11} > 0, \quad g_{22} > 0}$$

### Definiteness of quadratic forms

$$Q = \sum_{ik} a_{ik} x_i x_k = \text{quadratic form}$$

Q neg/pos definite, if  $Q \leq / \geq 0$  equal sign only for  $x_i \equiv 0$  e.g.  $x_1^2 + x_2^2$

Q neg/pos semidefinite, if  $Q \leq / \geq 0$  not only for  $x_i \equiv 0$  e.g.  $x_1^2 + 2x_1x_2 + x_2^2$   
 $= (x_1 + x_2)^2$

Q indefinite, if  $Q \leq 0$  e.g.  $x_1^2 - x_2^2$

$$Q = \sum_{ik} a_{ik} x_i x_k$$

Schur's criterion

for real symmetric  $Q$  ( $a_{ik} = a_{ki}$ )

is the form exactly then pos. respectively neg. definite if the suite of determinants defined by

$$D_1 = \begin{vmatrix} a_{11} & a_{12} & \dots & a_{1n} \\ a_{21} & a_{22} & \dots & a_{2n} \\ \dots & \dots & \dots & \dots \\ a_{n1} & a_{n2} & \dots & a_{nn} \end{vmatrix}$$

$$D_1 > 0, D_2 > 0, D_3 > 0, D_4 > 0, \dots, D_n > 0$$

or respectively, starting with negative determinants

$$D_1 < 0, D_2 > 0, D_3 < 0, D_4 > 0, \dots, D_n > 0 \text{ n pair}$$

$$D_n < 0 \text{ n mpair}$$

it is exactly then positive, resp. negative semidefinite if

$$D_1 > 0, D_2 > 0, D_3 > 0, D_4 > 0, \dots, D_n = 0$$

respectively

$$D_1 < 0, D_2 > 0, D_3 < 0, D_4 > 0, \dots, D_n = 0$$

in all other cases is the form indefinite.

Example

$$Q = x_1^2 + x_2^2 - 2x_1x_3 + x_3^2 = (x_1 - x_3)^2 + x_2^2$$

$$D_1 = \begin{vmatrix} 1 & 0 & -1 \\ 0 & 1 & 0 \\ -1 & 0 & 1 \end{vmatrix} \quad D_1 = 1 > 0, \quad D_2 = 1 > 0, \quad D_3 = 0 \quad \text{pos. semidefinite}$$

§3. The second groundform. Meusnier's theorem

$I = ds^2 = g_{ik} du^i du^k$  invariant quadratic groundform. Positive definiteness follows from its geometric content

$$x^i(u^k(s))$$

1.) Frenet:

$$\frac{1}{\rho} \hat{f}$$

$$n = v_i \perp \frac{\partial x^i}{\partial u^k}$$

$$\begin{aligned} \frac{d^2 x^i}{ds^2} &= \frac{d}{ds} \left( \frac{dx^i}{ds} \right) = \frac{d}{ds} \left( \frac{\partial x^i}{\partial u^k} \cdot \frac{du^k}{ds} \right) \\ &= \frac{\partial^2 x^i}{\partial u^k \partial u^l} \cdot \frac{du^l}{ds} \frac{du^k}{ds} + \frac{\partial x^i}{\partial u^k} \cdot \frac{d^2 u^k}{ds^2} \end{aligned}$$

$$v_i \frac{d^2 x^i}{ds^2} = v_i \frac{\partial^2 x^i}{\partial u^k \partial u^l} \frac{du^k}{ds} \frac{du^l}{ds} = \frac{1}{\rho} \underbrace{\hat{f} \cdot n}_{\cos \alpha} = \frac{1}{\rho} \cos \alpha \quad \text{invariant.}$$

$b_{kl} = b_{lk}$  covariant main tensor (fundamental quantities of 2nd order)

$$\begin{cases} b_{11} = L \\ b_{12} = b_{21} = M \\ b_{22} = N \end{cases}$$

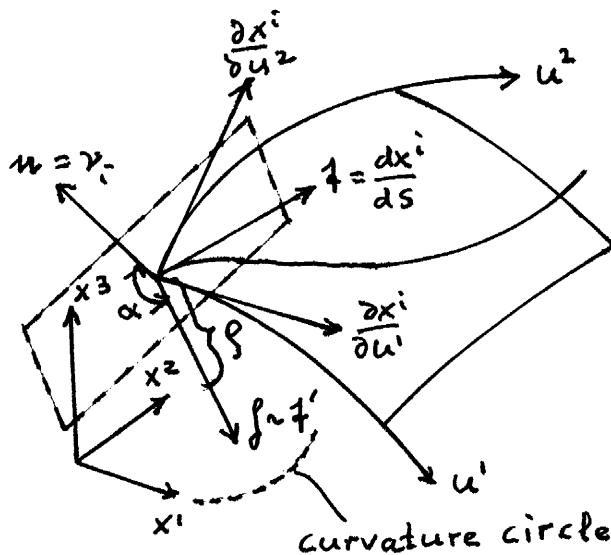

$$b_{kl} = v_i \frac{\partial^2 x^i}{\partial u^k \partial u^l} = \frac{1}{\sqrt{g}} ([\mathcal{C}_1, \mathcal{C}_2] \mathcal{C}_{kl}) = \frac{1}{\sqrt{g}} \langle \mathcal{C}_1, \mathcal{C}_2, \mathcal{C}_{kl} \rangle$$

$$b = b_{11}b_{22} - b_{12}^2$$

$$\Pi = b_{kl} du^k du^l \quad \text{2nd groundform invariant differential form}$$

$$\frac{1}{\rho} \cos \alpha = \frac{\Pi}{I} = \frac{b_{kl} du^k du^l}{g_{mn} du^m du^n}$$

Meusnier's theorem !



$$\rho = \underbrace{\text{const}}_{\pm R} \cdot \cos \alpha$$

$$\left\{ \begin{array}{l} \text{for } \alpha \leq 90^\circ \\ \text{for } \alpha \geq 90^\circ \end{array} \right.$$

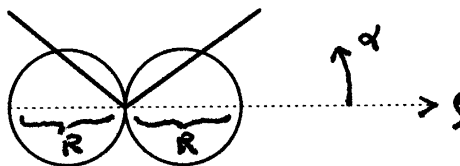

now fixed and the surface cut by several planes

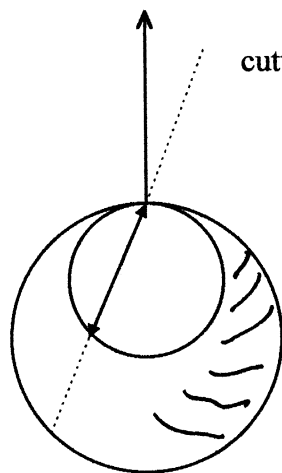

cutting surface

the totality of curvature centers lies on a circle

sphere (totality of curvature circles)

Meusnier's theorem states: the curvature circles of all plane surface cuts with common surface tangent lie on a sphere, respectively the curvature centers lie on a circle.

1.) Kronecker-symbol

$$\delta_{ik} = \delta_i^k = \begin{cases} 1 & \text{f. } i = k \\ 0 & \text{f. } i \neq k \end{cases}$$

$$\delta_{ik} = \delta_i^k = \begin{pmatrix} 1 & 0 & \dots & \dots & 0 \\ & 1 & \dots & \dots & \\ \cdot & & & & \\ \cdot & & & & \\ 0 & \dots & \dots & \dots & 1 \end{pmatrix} \text{ unit matrix}$$

$\epsilon_{ikl}$ - tensor (affintensor)

neighboring indices

$$\epsilon_{ikl} = \begin{cases} 1 & \text{f. pair permutation of. ind. } ikl \\ -1 & \text{f. impair " } \\ 0 & \text{otherwise (f. at least two equal indices)} \end{cases}$$

$$\epsilon_{123} = \epsilon_{231} = \epsilon_{312} = 1$$

$$\epsilon_{213} = \epsilon_{132} = \epsilon_{321} = -1$$

$$\epsilon_{ikl} = \begin{pmatrix} 0^{00} & 0^{01} & 0^{-1^0} \\ 0^{0^{-1}} & 0^{00} & 1^{00} \\ 0^{1^0} & -1^{00} & 0^{00} \end{pmatrix}$$

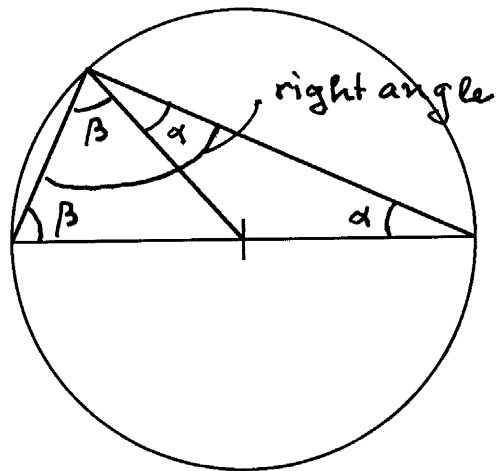

2 isosceles triangles: 1) with angle  $\alpha$

2) with angle  $\beta$

in the large triangle the sum of angles is  $2\alpha + 2\beta = \pi$

therefore  $\alpha + \beta = \frac{\pi}{2}$  is a right angle

## Meusnier suite

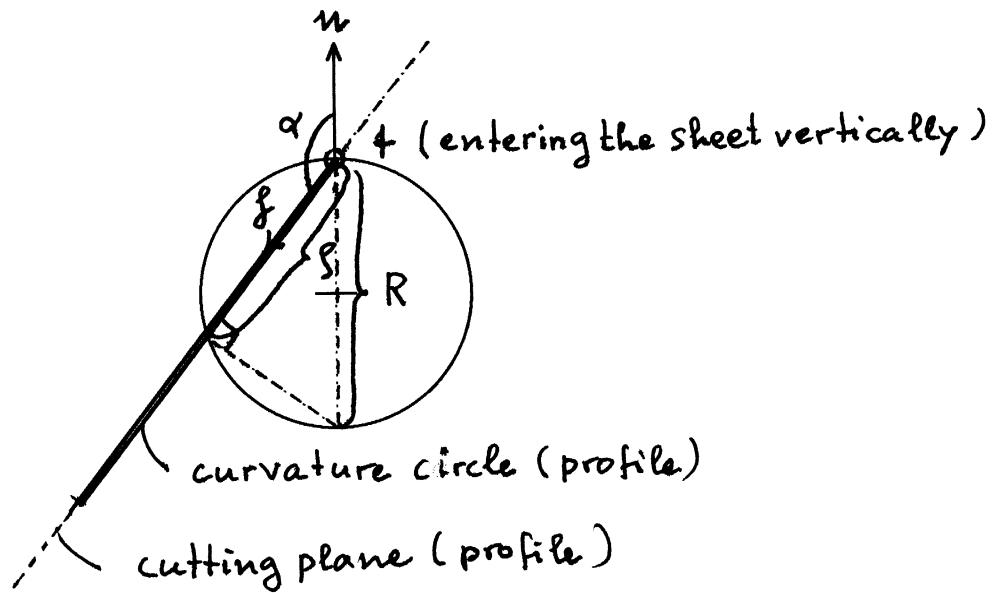

$$\rho = R \cos \alpha \rightarrow \frac{1}{\rho} \cos \alpha = \frac{1}{R}$$

$$\frac{1}{\rho} \cos \alpha = \frac{1}{R} = \frac{\Pi}{I} \quad \text{Meusnier}$$

invariant for a given surface

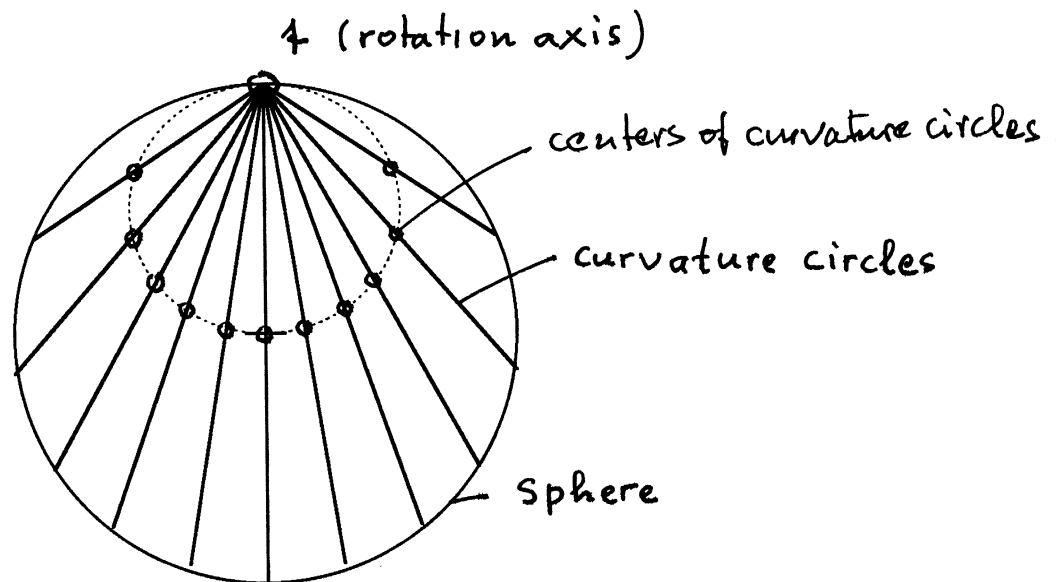

scalar product:  $(\mathbf{u}, \mathbf{v}) = a^i b^i$

$$\left\| \right\| v_i = \frac{1}{\sqrt{g}} \varepsilon_{ikl} \frac{\partial x^k}{\partial u^1} \frac{\partial x^l}{\partial u^2}$$

vektor product:  $[\mathbf{u}, \mathbf{v}] = \varepsilon_{ikl} a^k b^l$

$$i=1: a^2 b^3 - a^3 b^2$$

$$\begin{vmatrix} i & j & k \\ a^1 & a^2 & a^3 \\ b^1 & b^2 & b^3 \end{vmatrix}$$

Interpreting the 2nd groundform

$$x^i(u^m + \delta u^m) \approx x^i(u^m) + \frac{\partial x^i}{\partial u^k}(u^m) \delta u^k + \frac{1}{2!} \frac{\partial^2 x^i}{\partial u^k \partial u^l}(u^m) \delta u^k \delta u^l$$

$$\delta A = \xi^i v_i \approx \frac{1}{2!} \frac{\delta^2 x^i}{\partial u^k \partial u^l} \cdot v_i \delta u^k \delta u^l$$

$$x^i(u^m + \delta u^m) - x^i(u^m) \quad b_{kl}$$

$\delta u^k$  small

$$\boxed{2! dA = \Pi = b_{kl} du^k du^l} \quad \text{measure for bending away}$$

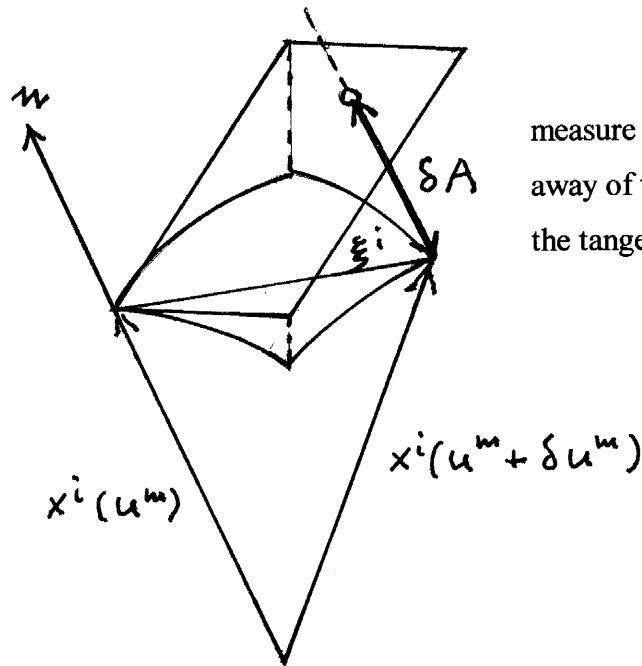

measure for bending  
away of the surface from  
the tangent plane

Metric

$$\delta A = \xi^i v_i \quad \delta u^i \rightarrow du^i$$

$$\Pi = 2! dA = b_{kl} du^k du^l \quad \text{bearing a sign}$$

$$b_{kl} \delta u^k \delta u^l = \text{const} \quad \text{centerform of a curve of 2nd degree.}$$

cutting the surface by a plane parallel with the tangent plane yields Dupin's indicatrix (curve of 2nd degree)

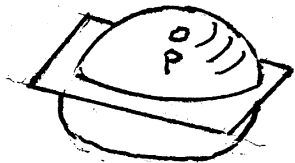

elliptic  $b > 0$

$$ax^2 + 2bxy + cy^2 = h^2$$



parabolic  $b = 0$

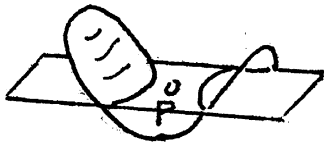

hyperbolic  $b < 0$

torus

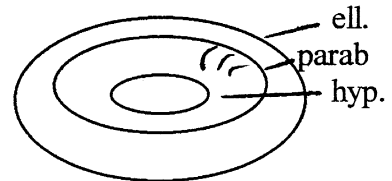

Example: saddle surface  $z = xy$

$\zeta$	$\zeta_u$	$\zeta_v$	$\zeta_{uu}$	$\zeta_{uv}$	$\zeta_{vv}$
u	1	0	0	0	0
v	0	1	0	0	0
uv	v	u	0	1	0

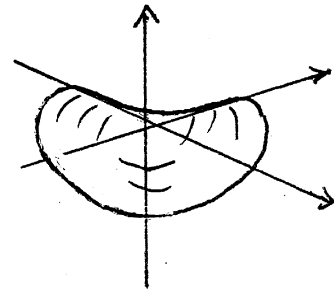

$$g_{ik} = \begin{pmatrix} \zeta_u^2 & \zeta_u \zeta_v \\ \zeta_u \zeta_v & \zeta_v^2 \end{pmatrix} = \begin{pmatrix} 1+v^2 & uv \\ uv & 1+u^2 \end{pmatrix}; \quad g = (1+v^2)(1+u^2) - u^2v^2 = 1+u^2+v^2$$

$$b_{ik} = \frac{1}{\sqrt{g}} \begin{pmatrix} \langle \zeta_u \zeta_v \zeta_{uu} \rangle & \langle \zeta_u \zeta_v \zeta_{uv} \rangle \\ \langle \zeta_u \zeta_v \zeta_{uv} \rangle & \langle \zeta_u \zeta_v \zeta_{vv} \rangle \end{pmatrix} = \frac{1}{\sqrt{1+u^2+v^2}} \begin{pmatrix} 0 & 1 \\ 1 & 0 \end{pmatrix}; \quad b = \frac{-1}{1+u^2+v^2}$$

$$I \quad ds^2 = (1+v^2)du^2 + 2uvdudv + (1+u^2)dv^2$$

$b < 0$  hyperbolic

$$\Pi = \frac{2}{\sqrt{1+u^2+v^2}} dudv$$

EX 6 torus   
 1. groundform   
 2. groundform   
 ell } po int s   
 hyp }   
 par }

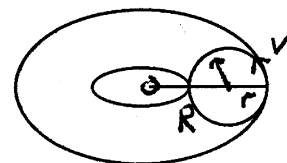

## Definition of the « group »

A not empty (finite or infinite) manifold  $\mathcal{M}$  of elements of any sort (e.g. numbers, restclasses, vectors, permutations, matrices, functions, transformations, representations...)  $a, b, \dots$ , is called a « group »  $\mathcal{G}$ , if the following 4 postulates are fulfilled:

[1] A law of composition (product) is defined, which associates to any pair of elements  $a, b \in \mathcal{M}$  an element  $c \in \mathcal{M}$  ..

$$a \bullet b = c$$

[2] The « product » is associative

$$(ab)c = a(bc)$$

[3] There exists at least one left sided unit element  $u_1 \in \mathcal{M}$ , such that for all  $a \in \mathcal{M}$  the following relation holds:

$$u_1 \bullet a = a$$

[4] For each  $a \in \mathcal{M}$  there exists at least one left sided inverse element  $a_1^{-1} \in \mathcal{M}$  such that

$$a_1^{-1} \bullet a = u_1$$

Examples

1.) Infinite group

positive rational numbers  $\frac{m}{n}$ , multiplication

$$[1] \frac{m}{n} \cdot \frac{m'}{n'} = \frac{mm'}{nn'} = \frac{m''}{n''}$$

$$[2] \left(\frac{m}{n} \cdot \frac{m'}{n'}\right) \cdot \frac{m''}{n''} = \frac{m}{n} \cdot \left(\frac{m'}{n'} \cdot \frac{m''}{n''}\right)$$

$$[3] \mathbf{1}_l = \frac{1}{1} (= \mathbf{1}_r)$$

$$[4] a_l^{-1} = \frac{n}{m} \text{ for } a = \frac{m}{n} (= a_r^{-1})$$

2.) Finite group  $A = \begin{pmatrix} 123 \\ 213 \end{pmatrix}$ ,  $B = \begin{pmatrix} 123 \\ 132 \end{pmatrix}$ ,  $E = \begin{pmatrix} 123 \\ 123 \end{pmatrix}$

		1. factor		
$A \cdot B = \begin{pmatrix} 123 \\ 312 \end{pmatrix}$		$E = \begin{pmatrix} 12 \\ 12 \end{pmatrix}$	$A = \begin{pmatrix} 12 \\ 21 \end{pmatrix}$	
$A \cdot E = A$	2. factor	$E = \begin{pmatrix} 12 \\ 12 \end{pmatrix}$	$A = \begin{pmatrix} 12 \\ 21 \end{pmatrix}$	groupable
		$A = \begin{pmatrix} 12 \\ 21 \end{pmatrix}$	$E = \begin{pmatrix} 12 \\ 12 \end{pmatrix}$	

groupable is symmetric, group is commutative. (Abelian group) }<sup>(2)</sup> (name)

Manifolds for which some of the postulates are violated:

[1] violated for 0,1,...,9 and addition (or vectors and scalarproduct)

[2] violated for

$$0, \pm 1, \pm 2, \dots; \quad n \circ m = \left\lfloor \frac{n+m}{2} \right\rfloor \text{ rounded off downwards to the next integer} \quad \begin{matrix} [3,6] = 3 \\ [-2,5] = -3 \end{matrix}$$

e.g.  $n = 0, m = 2, l = 4$

$$\left[ \frac{\left\lfloor \frac{n+m}{2} \right\rfloor + 1}{2} \right] = 2 \neq \left[ \frac{n + \left\lfloor \frac{m+l}{2} \right\rfloor}{2} \right] = 1$$

$(n \circ m) \circ l$                        $n \circ (m \circ l)$

[3] violated: (2  $u_r$ , no  $u_l$ )

$u = (0,0); \quad b = (0,1) \quad r = (1,0) \quad s = (1,1)$

$z = (x_1, x_2)$

$w = (y_1, y_2)$

$z \circ w = (x_1(y_1 - y_2); x_2(y_1 - y_2))$

$27 \equiv 1 \pmod{2}$

$-1 \equiv 1 \pmod{2}$

each component modulo 2 reduced

-1 is congruent 27 modulo 2

$16 \equiv 4 \pmod{4}$

[4] violated for

0,1,2,.....and addition

		2nd factor			
		$u$	$b$	$r$	$s$
1st factor	$u$	$u$	$u$	$u$	$u$
	$b$	$u$	$b$	$b$	$u$
	$r$	$u$	$r$	$r$	$u$
	$s$	$u$	$s$	$s$	$u$



§3. Transformation groups in the plane

$$\left. \begin{aligned} x &= x(u, v; \overbrace{a_1 \dots a_n}^{a_\nu}) \\ y &= y(u, v; \overbrace{b_1 \dots b_m}^{b_\mu}) \end{aligned} \right\} \text{point transformation}$$

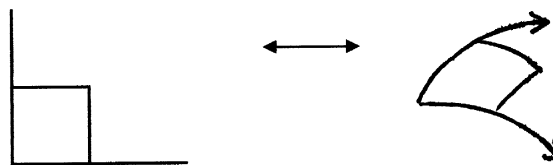

$$\left. \begin{aligned} u \\ v \end{aligned} \right\} \rightarrow \left. \begin{aligned} x \\ y \end{aligned} \right\} \rightarrow \left. \begin{aligned} \xi \\ \eta \end{aligned} \right\} \quad \ll \text{product} \gg$$

group::

[1] product of two transformations is again transformation of the manifold

[2] identity transformation  $x = u \quad y = v$  is contained in the manifold

[3] inverse transformation contained in the manifold?

transformation groups are always associative

Examples 1.)  $a \neq 0 \quad b \neq 0$

$$\begin{aligned} x &= au & u &= \alpha\xi & \text{product} & x &= \overbrace{a\alpha\xi}^A \\ y &= bv & v &= \beta\eta & & y &= \overbrace{b\beta\eta}^B \end{aligned}$$

$$\begin{aligned} \text{inverse transformation} & & u &= \frac{1}{a}x \\ & & v &= \frac{1}{b}y \end{aligned}$$

$$2.) \begin{aligned} x &= au & u &= \alpha\xi & x &= a\alpha\xi \\ y &= bu & v &= \beta\xi & y &= b\alpha\xi \end{aligned} \quad [2] \text{ violated}$$

$$3.) \begin{aligned} x &= auv & u &= \alpha\xi\eta & x &= a\alpha\beta\xi^2\eta \\ y &= bu & v &= \beta\xi & y &= b\alpha\xi\eta \end{aligned} \quad [1] \text{ violated } [2] \text{ violated anyway}$$

if [2] violated, then [3] always violated

Definition

1.) A partial manifold of a transformation group, which is a group in itself, is called a subgroup.

2.) A group is called r - membered, if the single transformation is specified by exactly r independent essential parameters.

3.) Every quantity  $\mathfrak{I}$  is called invariant of the group, if for each  $\overline{\mathfrak{I}}$ , which is generated from  $\mathfrak{I}$  by transformation, the following is valid:  $\overline{\mathfrak{I}} = \Phi \bullet \mathfrak{I}$ , where  $\Phi$  must only depend on  $a_\nu, b_\nu$  respectively. In case that  $\Phi = 1$ ,  $\mathfrak{I}$  is called absolute invariant. In case that  $\Phi \neq 1$  we call  $\mathfrak{I}$  relative invariant.

§5.) Co - and contravariant components for a special affine transformation in the plane

1.) Coordinates

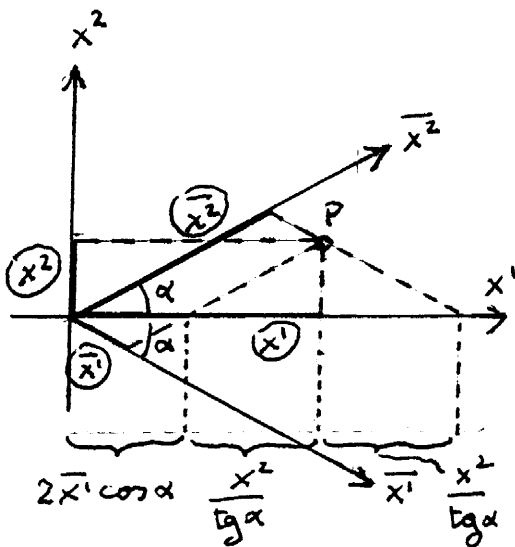

$$2\bar{x}^1 \cos\alpha = x^1 - \frac{x^2}{\operatorname{tg}\alpha}$$

$$2\bar{x}^2 \cos\alpha = x^1 + \frac{x^2}{\operatorname{tg}\alpha}$$

$$\begin{aligned} \bar{x}^1 &= \frac{1}{2 \cos\alpha} x^1 - \frac{1}{2 \sin\alpha} x^2 \\ \bar{x}^2 &= \frac{1}{2 \cos\alpha} x^1 + \frac{1}{2 \sin\alpha} x^2 \end{aligned}$$

$$C = \begin{pmatrix} \frac{1}{2 \cos\alpha} & -\frac{1}{2 \sin\alpha} \\ \frac{1}{2 \cos\alpha} & \frac{1}{2 \sin\alpha} \end{pmatrix}$$

contravariant !

2.) Projections

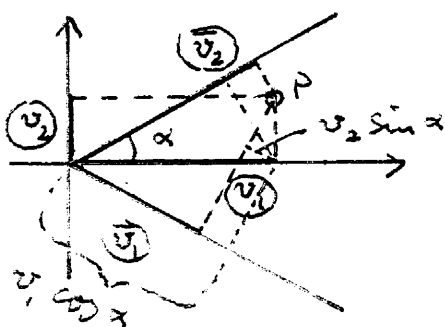

$$\begin{aligned} \bar{v}_1 &= \cos\alpha v_1 - \sin\alpha v_2 \\ \bar{v}_2 &= \cos\alpha v_1 + \sin\alpha v_2 \end{aligned}$$

$$D = \begin{pmatrix} \cos\alpha & -\sin\alpha \\ \cos\alpha & \sin\alpha \end{pmatrix}$$

covariant !

$$D' = \begin{pmatrix} \cos\alpha & \cos\alpha \\ -\sin\alpha & \sin\alpha \end{pmatrix}$$

e.g. decomposition of a force; components, work resp.

$$C \cdot D' = \begin{pmatrix} 1 & 0 \\ 0 & 1 \end{pmatrix} = E$$

the two transformations are contragredient

Two matrices C and D are contragredient if

$$(C \cdot D')' = E' = E$$

$$D'' \cdot E$$

$$D$$

Remark D' is the transposed matrix usually denoted D<sup>+</sup>

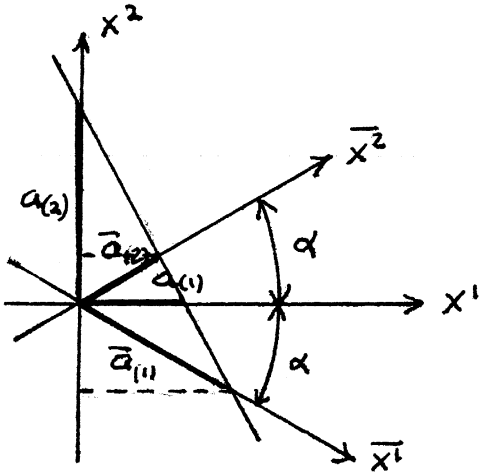
3.) Axis segments

segment equations

$$\frac{x^1}{a(1)} + \frac{x^2}{a(2)} = 1 \rightarrow \frac{\bar{x}^1}{\bar{a}(1)} + \frac{\bar{x}^2}{\bar{a}(2)} = 1$$

beam theorem

$$\frac{\bar{a}(1) \cos \alpha}{a(1)} = \frac{a(2) + \bar{a}(1) \sin \alpha}{a(2)}$$

$$\frac{\bar{a}(2) \cos \alpha}{a(1)} = \frac{a(2) - \bar{a}(2) \sin \alpha}{a(2)}$$

$$\bar{a}(1) = \frac{a(1)a(2)}{a(2) \cos \alpha - a(1) \sin \alpha}$$

$$\bar{a}(2) = \frac{a(1)a(2)}{a(2) \cos \alpha + a(1) \sin \alpha}$$

not contravariant

not covariant

not linear

4.) Straightline coordinates  $c_i = \frac{1}{a(i)}$ 

$$\bar{c}_1 = \cos \alpha c_1 - \sin \alpha c_2$$

$$\bar{c}_2 = \cos \alpha c_1 + \sin \alpha c_2$$

covariant

Ex8

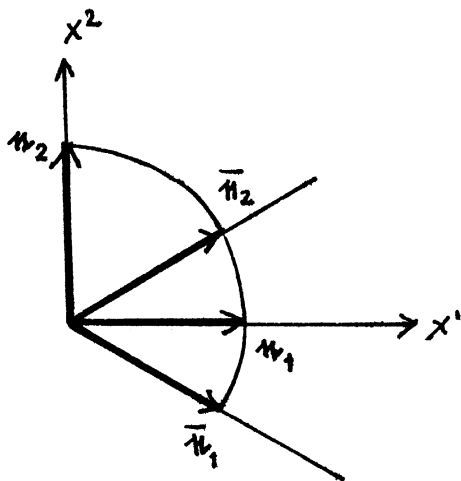

α.) basis vectors  $n_1, n_2 \rightarrow \bar{n}_1, \bar{n}_2$

show that they transform covariantly and derive the transformation relations

β.) reciprocal basis vectors

$$n_j n^k = \delta_j^k$$

$n^k \rightarrow \bar{n}^k$  geometrical interpretation

$$\bar{n}_j \bar{n}^k = \delta_j^k$$

γ.) reciprocal coordinates

$$\sigma_i n^i = \bar{\sigma}_i \bar{n}^i$$

δ.) vertical length  $\ell^{(i)}$

$$\bar{\ell}^i = \frac{\ell^{(i)}}{\sin 2\alpha} \quad \text{vertical replacement quantities}$$

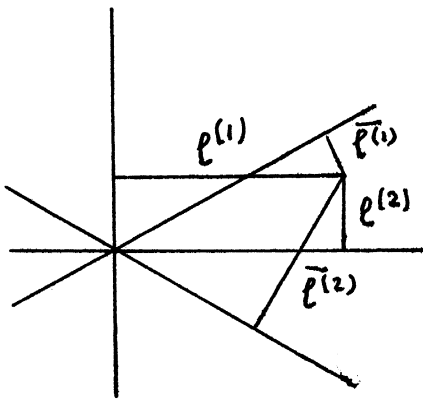

It is a fact of experience that these two transformations are sufficient

§6. Surface vectors

$x^i(u^k)$  ( $i=1,2,3$ ) ( $k=1,2$ )

$\frac{\partial x^i}{\partial u^k}$  tangent vectors

$u^k(t)$  curve through P

$\vec{\lambda} = \frac{dx^i}{dt} = \frac{\partial x^i}{\partial u^k} \cdot \frac{du^k}{dt}$   $\dot{\lambda} = \frac{dx^i}{ds}$

$|\mathcal{C}_k| = \left| \frac{\partial x^i}{\partial u^k} \right| = \sqrt{g_{kk}}$  ( $k$  no summation  $k \rightarrow \dot{k}$ )

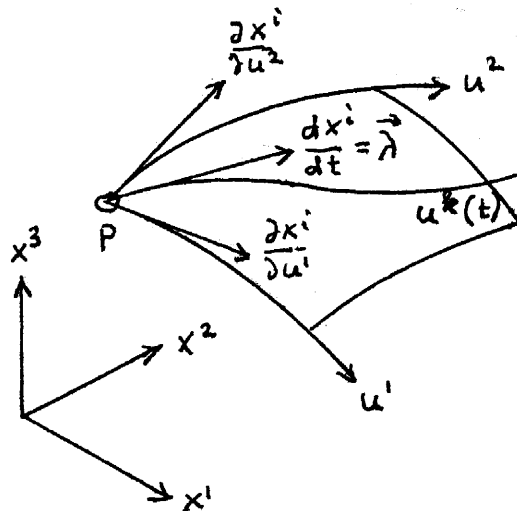

Definitions:

1.) Natural contravariant components

= oblique angle coord.  $\lambda^k$  in multiples of 1

$\lambda = \frac{1}{\sqrt{g_{kk}}} \cdot \frac{\partial x^i}{\partial u^k} \cdot \sqrt{g_{kk}} \cdot \frac{du^k}{dt}$   
 unit vect.  $\lambda^k$

2.) Contravariant components

= oblique angle coord. in multiples of  $\sqrt{g_{kk}}$

$\vec{\lambda} = \frac{\partial x^i}{\partial u^k} \frac{du^k}{dt}$   $\frac{\partial x^i}{\partial u^k}$  contrav. basis vect.

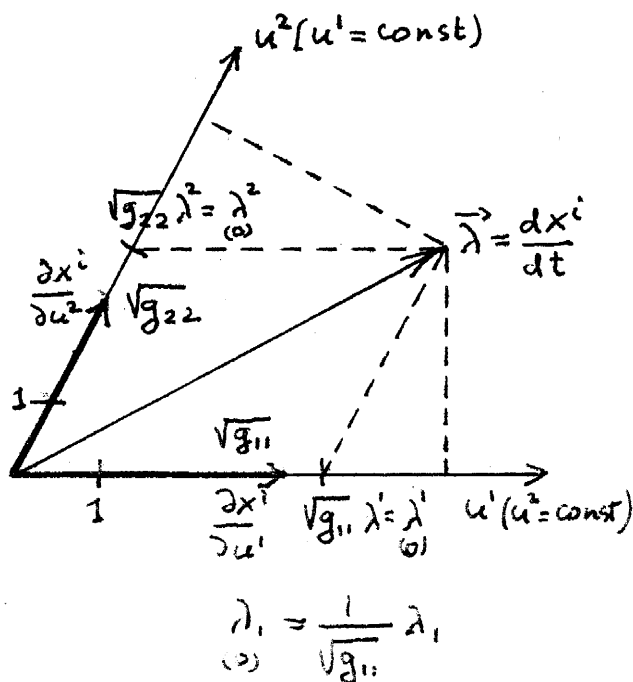

3.) Natural covariant components

= projections  $\lambda_k$  in multiples of 1

$\lambda_k = \frac{1}{\sqrt{g_{kk}}} \frac{\partial x^i}{\partial u^k} \cdot \frac{dx^i}{dt} = \frac{1}{\sqrt{g_{kk}}} \frac{\partial x^i}{\partial u^k} \cdot \frac{\partial x^i}{\partial u^l} \cdot \frac{du^l}{dt}$   
 unit vector  $\vec{\lambda}$   $g_{kl}$   $\lambda^l$

4.) Covariant components

= projektions  $\lambda_k$  in multiples of  $\frac{1}{\sqrt{g_{kk}}}$   $\lambda_k = \frac{1}{\sqrt{g_{kk}}} \lambda_k$

$\lambda_k = \sqrt{g_{kk}} \lambda_k$   $\lambda^k = \sqrt{g_{kk}} \lambda^k$  transformation prescription  $\lambda_k = g_{kl} \lambda^l$

$$\lambda_1 = g_{11}\lambda^1 + g_{12}\lambda^2$$

$$\lambda_2 = g_{21}\lambda^1 + g_{22}\lambda^2$$

$$g = g_{11}g_{22} - g_{12}^2$$

$$\lambda^1 = \frac{g_{22}}{g}\lambda_1 + \frac{-g_{12}}{g}\lambda_2$$

$$\lambda^2 = \frac{-g_{21}}{g}\lambda_1 + \frac{g_{11}}{g}\lambda_2$$

definition: in the  $R_2$

$g^{11} = \frac{g_{22}}{g}$	$g^{12} = \frac{-g_{12}}{g} = g^{21}$	$g^{22} = \frac{g_{11}}{g}$
-----------------------------	---------------------------------------	-----------------------------

then is

$$\left. \begin{aligned} \lambda^1 &= g^{11}\lambda_1 + g^{12}\lambda_2 \\ \lambda^2 &= g^{21}\lambda_1 + g^{22}\lambda_2 \end{aligned} \right\}$$

$\lambda^k = g^{km}\lambda_m$
-------------------------------

compact form

inversion condition

$$\lambda^k = \underbrace{g^{km}g_{ml}}_{\delta_l^k} \lambda^l$$

$$\lambda_k = g_{kl}\lambda^l \quad \text{substituted for } k = m$$

$g^{km}g_{ml} = \delta_l^k$
-----------------------------

$$\zeta_k = \frac{\partial x^i}{\partial u^k}$$

$$n_k = \frac{\zeta_k}{|\zeta_k|}$$

1.) Natural contravariant comp.

$$\bar{\lambda} = n_k \lambda^k$$

2.) Contravariant comp.

$$\bar{\lambda} = \zeta_k \lambda^k$$

3.) Natural covariant comp.

$$\lambda_k = n_k \bar{\lambda}$$

4.) Covariant comp.

$$\lambda_k = \zeta_k \bar{\lambda}$$

coordinates

projections

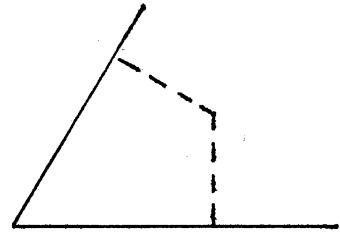
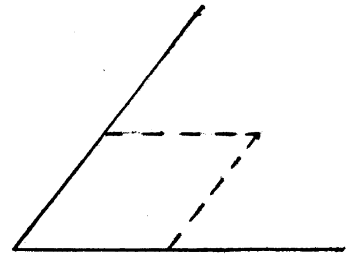

EX9

	1.)	2.)	3.)	4.)
1.) (transformation formulas)				
2.)		(x)		
3.)			( )	
4.)				(*)

1.) Transformation of contravariant components

$u^k(\bar{u}^1) \leftrightarrow \bar{u}^1(u^k)$  different parameterform

$$\bar{\lambda} = \frac{dx^i}{dt} = \underbrace{\frac{\partial x^i}{\partial u^k}}_{\frac{\partial x^i}{\partial \bar{u}^1}} \cdot \underbrace{\frac{\partial u^k}{\partial \bar{u}^1}}_{\bar{\lambda}^1} \frac{d\bar{u}^1}{dt}$$

$x^i(u^k(\bar{u}^1(t)))$

representation of the space curve

comparison of coefficients yields the transformation prescription.

$$\boxed{\bar{\lambda}^1 = \frac{\partial \bar{u}^1}{\partial u^k} \lambda^k} \quad \boxed{\lambda^k = \frac{\partial u^k}{\partial \bar{u}^1} \bar{\lambda}^1}$$

↙ resolved ↘

2.) Transformation prescription for covariant components

$$\begin{aligned} \bar{\lambda}_k &= \bar{g}_{kl} \bar{\lambda}^l = \frac{\partial x^i}{\partial \bar{u}^k} \cdot \frac{\partial x^i}{\partial \bar{u}^l} \frac{\partial \bar{u}^l}{\partial u^m} \lambda^m \\ &= \frac{\partial x^i}{\partial u^\alpha} \frac{\partial u^\alpha}{\partial \bar{u}^k} \cdot \frac{\partial x^i}{\partial u^\beta} \frac{\partial u^\beta}{\partial \bar{u}^l} \frac{\partial \bar{u}^l}{\partial u^m} \lambda^m \\ &= \frac{\partial u^\alpha}{\partial \bar{u}^k} \cdot \underbrace{g_{\alpha\beta} \delta_m^\beta \lambda^m}_{\lambda^\alpha} \quad \frac{\partial u^\beta}{\partial u^m} = \delta_m^\beta \end{aligned}$$

$k \rightarrow l$

$\alpha \rightarrow k$

$$\boxed{\bar{\lambda}_l = \frac{\partial u^k}{\partial \bar{u}^l} \lambda_k}$$

transformation condition

$$\boxed{\lambda_k = \frac{\partial \bar{u}^l}{\partial u^k} \bar{\lambda}_l}$$

resolved relation

By means of the transformation relation the four remaining spaces in exercise 9 can be filled in.

Two already given.



§ 7. Elements of tensor calculus

quantities in  $u^k$  - system without bars e.g.

$$\alpha, \xi_i, \eta^k, a_{mn}, \dots$$

quantities in  $\bar{u}^l$  - system with bars e.g.

$$\bar{\alpha}, \bar{\xi}_i, \bar{\eta}^k, \bar{a}_{mn}, \dots$$

Definitions:

(1.) 0 rank tensor scalar

has the property of being conserved during transition to another system

$$\bar{\alpha} = \alpha \quad \text{absolute invariant}$$

New definition of a scalar: absolutely invariant against transformations

Example

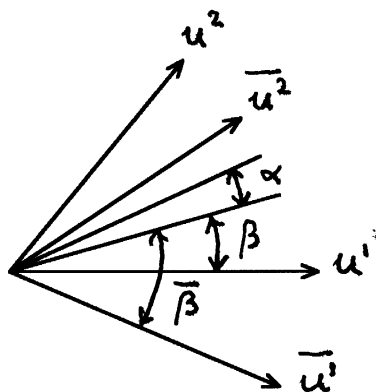

$\alpha$  is a scalar

(2.) 1st rank tensor vector

new vectordefinition

1. Definition. as contravariant vector or 1st rank tensor ( $\eta^k$ ) we define a system of quantities under the condition that the following recalculation prescription holds for a transition to a new parameter system:

$$\boxed{\bar{\eta}^k = \frac{\partial \bar{u}^k}{\partial u^l} \eta^l} \quad n - \text{dimensional}$$

example:

$$d\bar{u}^k = \frac{\partial \bar{u}^k}{\partial u^l} du^l \quad \text{contravariant vector}$$

complete differential

2. Definition: the covariant vector or 1st rank tensor ( $\xi_l$ ) is a system of quantities such that

$$\boxed{\xi_l \eta^l = \bar{\xi}_k \bar{\eta}^k} \quad \text{invariant}$$

cov. vect to be def.. arbitrary contrav..vect.

$$\text{it follows } \eta^l \xi_l = \frac{\partial \bar{u}^k}{\partial u^l} \eta^l \bar{\xi}_k \rightarrow \xi_l = \frac{\partial \bar{u}^k}{\partial u^l} \bar{\xi}_k$$

or

$$\boxed{\bar{\xi}_k = \frac{\partial u^l}{\partial \bar{u}^k} \xi_l} \quad \text{as transformation prescription for covariant vectors}$$

inversion:

$$\eta_l \xi^l = \bar{\eta}_k \bar{\xi}^k \quad \text{and} \quad \eta_l = \frac{\partial \bar{u}^k}{\partial u^l} \bar{\eta}^k, \text{ it follows}$$

$$\frac{\partial \bar{u}^k}{\partial u^l} \bar{\eta}_k \xi^l = \bar{\eta}_k \bar{\xi}^k \rightarrow \bar{\xi}^k = \frac{\partial \bar{u}^k}{\partial u^l} \xi^l$$

transformation prescription for contravariant vectors

(3.) 2nd rank tensors

1.) Definition: it is an invariance postulate: a covariant 2nd rank tensor ( $a_{mn}$ ) = system of quantities + recalculation prescription

$$\boxed{a_{mn} \xi^m \eta^n = \bar{a}_{pq} \bar{\xi}^p \bar{\eta}^q} \quad \text{invariance}$$

consequence:

$$a_{mn} \xi^m \eta^n = \bar{a}_{pq} \frac{\partial \bar{u}^p}{\partial u^m} \xi^m \frac{\partial \bar{u}^q}{\partial u^n} \eta^n$$

$$a_{mn} = \frac{\partial \bar{u}^p}{\partial u^m} \cdot \frac{\partial \bar{u}^q}{\partial u^n} \bar{a}_{pq}$$

$$\boxed{\bar{a}_{pq} = \frac{\partial u^m}{\partial \bar{u}^p} \frac{\partial u^n}{\partial \bar{u}^q} a_{mn}}$$

2.) Definition: if a system of quantities satisfies the following invariance postulate, then we call it a contravariant 2nd rank tensor, i.e. if

$$a^{mn} \xi_m \eta_n = \bar{a}^{pq} \bar{\xi}_p \bar{\eta}_q$$

substituting for the quantities with the bars the transformation prescription yields

$$\boxed{\bar{a}^{pq} = \frac{\partial \bar{u}^p}{\partial u^m} \frac{\partial \bar{u}^q}{\partial u^n} a^{mn}}$$

3.) Definition: invariance postulate; mixed 2nd rank tensor ( $a_m^{\bullet n}$ )

$$\boxed{a_m^{\bullet n} \xi^m \eta_n = \bar{a}_p^{\bullet q} \bar{\xi}^p \bar{\eta}_q} \quad \text{invariance}$$

it follows the transformation prescription

$$\boxed{\bar{a}_p^{\bullet q} = \frac{\partial u^m}{\partial \bar{u}^p} \cdot \frac{\partial \bar{u}^q}{\partial u^n} a_m^{\bullet n}}$$

or

$$\boxed{a_m^{\bullet n} \xi^m \eta_n = \bar{a}_{\bullet q}^p \bar{\xi}^p \bar{\eta}_q} \quad \text{mixed tensor}$$

$$\bar{a}_{\bullet q}^p = \frac{\partial \bar{u}^p}{\partial u^m} \cdot \frac{\partial u^n}{\partial \bar{u}^q} a_m^{\bullet n} \quad \left( a_m^{\bullet n} \neq a_{\bullet n}^m \right)$$

(4.) 3rd rank tensors

$$b_{i k l} \quad \left. \vphantom{b_{i k l}} \right\} \text{covariant}$$

$$\left. \begin{array}{l} b_{i \bullet k l}, \quad b_{i \bullet \bullet l}, \quad b_{i k \bullet l} \\ b_{\bullet \bullet l}^{i k}, \quad b_{\bullet k}^{i \bullet l}, \quad b_{i \bullet}^{\bullet k l} \end{array} \right\} \text{mixed}$$

$$b^{i k l} \quad \left. \vphantom{b^{i k l}} \right\} \text{contravariant.}$$

example

$$\left| b_{i \bullet l}^{\bullet k} \bullet \xi^i \eta_k \zeta^l = \bar{b}_{p \bullet r}^{\bullet q} \bullet \bar{\xi}^p \bar{\eta}_q \bar{\zeta}^r \right| \quad \text{invariance}$$

consequence

$$\left| \bar{b}_{p \bullet r}^{\bullet q} = \frac{\partial u^i}{\partial \bar{u}^p} \frac{\partial \bar{u}^q}{\partial u^k} \frac{\partial u^l}{\partial \bar{u}^r} b_{i \bullet l}^{\bullet k} \right| \quad \text{transformation prescription}$$

(5.) n-th rank tensors

number systems c

$$c_{\cdot \cdot \cdot k \cdot \cdot \cdot}^{\cdot \cdot \cdot l \cdot \cdot \cdot}, \quad 2^n \text{ forms}$$

invariance postulate

$$\left| c_{\cdot \cdot \cdot k \cdot \cdot \cdot}^{\cdot \cdot \cdot l \cdot \cdot \cdot} \bullet \dots \bullet \xi^k \bullet \dots \bullet \eta_l \bullet \dots = \bar{c}_{\cdot \cdot \cdot p \cdot \cdot \cdot}^{\cdot \cdot \cdot q \cdot \cdot \cdot} \bullet \dots \bullet \bar{\xi}^p \bullet \dots \bullet \bar{\eta}_q \bullet \dots \right|$$

it follows

$$\left| \bar{c}_{\cdot \cdot \cdot p \cdot \cdot \cdot}^{\cdot \cdot \cdot q \cdot \cdot \cdot} = \dots \bullet \frac{\partial u^k}{\partial \bar{u}^p} \bullet \dots \bullet \frac{\partial \bar{u}^q}{\partial u^l} \bullet \dots \bullet c_{\cdot \cdot \cdot k \cdot \cdot \cdot}^{\cdot \cdot \cdot l \cdot \cdot \cdot} \right|$$

transformation prescription

Calculation rules

((1)) Addition

$$a_{k \bullet m}^{\bullet 1} + b_{k \bullet m}^{\bullet 1} = c_{k \bullet m}^{\bullet 1} \quad \text{only for tensors of the same kind}$$

$$(a_{kl} + b^{kl} \text{ senseless!})$$

((2)) Product (dyadic)

$$a_k^{\bullet 1} \bullet b_{mn}^{\bullet \bullet p} = c_{k \bullet mn}^{\bullet 1 \bullet \bullet p}$$

((3)) Contraction

equalization of two indices of opposite stand

(summation over this index; e.g. traceformation) (rem. for 2nd rank tensor yields scalar)

$$c_i^{\bullet k l} \rightarrow i=l \rightarrow c_i^{\bullet k i} = d^k$$

e.g.

$$\xi_i \eta^k = c_i^{\bullet k} \begin{pmatrix} \xi_1 \eta^1 & \bullet \\ \bullet & \xi_2 \eta^2 \end{pmatrix} \quad i=k \rightarrow \xi_1 \eta^1 + \xi_2 \eta^2$$

invariance:

$$c_i^{\bullet k l} \alpha^i \beta_k \gamma_l \rightarrow c_i^{\bullet k i} \bullet \beta_k \underbrace{\alpha^i \gamma_i}_{V \text{ inv. (here summation over i)}}$$

$$c_i^{\bullet 1} \alpha^i \gamma_1 = c_1^{\bullet 1} \alpha^1 \gamma_1 + c_2^{\bullet 1} \alpha^2 \gamma_1 + c_1^{\bullet 2} \alpha^1 \gamma_2 + c_2^{\bullet 2} \alpha^2 \gamma_2$$

1.) scalarproduct of  $\xi^i, \eta_k = \text{tenspr. } \xi^i \bullet \eta_k = a_{\bullet k}^i$  contracted  $i=k$   $\xi^i \eta_i = a_{\bullet i}^i = a$

2.) vectorproduct of  $\xi^i, \eta^k = \text{tensproduct with } \varepsilon_{ikl}$  in the  $R_3$

$$\varepsilon_{ikl} \xi^p \eta^q = a_{i k l}^{\bullet \bullet \bullet p q} \text{ contracted twice } k=p, l=q$$

$$\varepsilon_{ikl} \xi^k \eta^l = a_{i k l}^{\bullet \bullet \bullet k l} = a_i$$

3.) matrixproduct of  $a_i^{\bullet k}$  and  $b_1^{\bullet m} = \text{tensprod. contracted } k=l$

$$a_i^{\bullet k} \bullet b_1^{\bullet m} = c_i^{\bullet k \bullet m} = c_i^{\bullet m}$$

$$\begin{pmatrix} b_{11} & \bullet \\ b_{21} & \bullet \end{pmatrix}$$

$$c_1^{\bullet 1} = a_1^{\bullet k} b_k^{\bullet 1} = a_1^{\bullet 1} b_1^{\bullet 1} + a_1^{\bullet 2} b_2^{\bullet 1} = a_{11} b_{11} + a_{12} b_{21}$$

$$\begin{pmatrix} a_{11} & a_{12} \\ \bullet & \bullet \end{pmatrix} \begin{pmatrix} a_{11} b_{11} + a_{12} b_{21} = c_{11} & \bullet \\ \bullet & \bullet \end{pmatrix}$$

4.) 3rd order determinant with  $\xi^i, \eta^k, \zeta^l$  as columnvectors = tenspr with  $\varepsilon_{pqr}$  contracted

$$(p=i, q=k, r=l)$$

$$\text{Det} \left| \xi^i \eta^k \zeta^l \right| = \varepsilon_{pqr} \xi^i \eta^k \zeta^l = \varepsilon_{ikl} \xi^i \eta^k \zeta^l$$

$$p=i, q=k, r=l$$

$$= \xi^1 \eta^2 \zeta^3 - \xi^1 \eta^3 \zeta^2 \quad \left| \begin{array}{ccc} \xi^1 & \eta^1 & \zeta^1 \\ \xi^2 & \eta^2 & \zeta^2 \\ \xi^3 & \eta^3 & \zeta^3 \end{array} \right|$$

$$\varepsilon_{123} = \varepsilon_{312} = \varepsilon_{231} = 1$$

$$\varepsilon_{132} = \varepsilon_{213} = \varepsilon_{321} = -1$$

$$\varepsilon_{ikl} = 0 \text{ otherwise}$$

((4)) convolution ((2)) + ((3))

$$a_k^{\bullet 1} \bullet b_{mn} \quad (\text{with } k=l=m) = a_k^{\bullet 1} \bullet b_{ln} = c_k^{\bullet 1} \bullet ln$$

↙ arbitrary tensor

((5))  $\left\{ \begin{array}{l} \text{elevating} \\ \text{lowering} \end{array} \right\}$  of an index ((2)) + ((3))

fundamental tensor

$$a_k^{\bullet 1} \bullet g_{mn} \quad (\text{with } k=l=m) = a_k^{\bullet 1} \bullet g_{ln} = a_k^{\bullet 1} \bullet ln = \underbrace{a_{kn}}_{\text{nomination}} \quad \text{same main letter}$$

$$n \lambda^k \bullet g_{kl} = \lambda_l \quad \text{respectively} \quad \lambda_k \bullet g^{kl} = \lambda^l$$

in general there is  $a_k^{\bullet 1} \neq a_{\bullet k}^1$

e.g.  $k=1, l=2$  (dimension = 2)

$$\begin{array}{ll} a_k^{\bullet 1} = a^{i1} \bullet g_{ik} & a_1^{\bullet 2} = a^{12} \bullet g_{11} + a^{22} \bullet \underline{g_{21}} \\ a_{\bullet k}^1 = a^{ki} \bullet g_{ik} & a_2^{\bullet 1} = a^{21} \bullet g_{11} + a^{22} \bullet \underline{g_{12}} \end{array} \quad \text{only equal for } a^{12} = a^{21} \text{ i.e.f. symmetry!}$$

### Theorem

for symmetric tensors  $a^{il} = a^{li}$  there is

$$a_k^{\bullet 1} = a_{\bullet k}^1 = a_k^1$$

$$g_{ik} g^{kl} = g_i^l = \delta_i^l$$

contracted.  $\delta_i^i = d = \text{dimens. number}$

$$a_k^{\bullet 1} \bullet g^{km} = a^{ml}$$

$$a_{\bullet k}^1 \bullet g^{km} = a^{lm}$$

Splitting theorem:

$$a_{ik} = \frac{1}{2} \underbrace{(a_{ik} + a_{ki})}_{\text{symm.}} + \frac{1}{2} \underbrace{(a_{ik} - a_{ki})}_{\text{antim.}}$$

*Repetition*

$$c_{\dots k \dots}^{\dots l \dots}$$

$$c_{\dots k \dots}^{\dots l \dots} \cdot \xi^k \cdot \eta_l = \bar{c}_{\dots p \dots}^{\dots q \dots} \cdot \bar{\xi}^p \cdot \bar{\eta}_q \dots$$

$$\bar{c}_{\dots p \dots}^{\dots q \dots} = \frac{\partial u^k}{\partial \bar{u}^p} \frac{\partial \bar{u}^q}{\partial u^l} c_{\dots k \dots}^{\dots l \dots}$$

((1)) Addition  $a_k^{\bullet l} + b_k^{\bullet l} = c_k^{\bullet l}$

((2)) Product  $a_k^{\bullet l} \cdot b_{mn}^{\bullet p} = c_{k \bullet mn}^{\bullet l \bullet p}$

((3)) Contraction  $c_i^{\bullet k l} \rightarrow i = l \rightarrow c_i^{\bullet k i} = d^k$

((4)) Convolution ((2)) + ((3))<sub>simple</sub>

((5))  $\left. \begin{array}{l} \text{elevation} \\ \text{lowering} \end{array} \right\} \text{of an index } ((2))_{\text{fund}} + ((3))_{\text{simple}}$



$$(\bar{a}_i = \frac{\partial u^k}{\partial u^i} a_k)$$

notion	covar. comp. $a_i$	nat. covar. comp. $a_i = a_i \frac{1}{\sqrt{g_{ii}}}$ (*)	contrav. comp. $a^i = g^{ik} a_k$	nat. contrav. comp. $a^i = a^i \sqrt{g_{ii}}$ (*)
velocity				
1) cart. x,y syst. $ds^2 = dx^2 + dy^2$	$(\dot{x}, \dot{y})$	$(\dot{x}, \dot{y})$	$(\dot{x}, \dot{y})$	$(\dot{x}, \dot{y})$
2) polar r, $\phi$ Syst. $ds^2 = dr^2 + r^2 d\phi^2$	$(\dot{r}, r^2 \dot{\phi})$	$(\dot{r}, r\dot{\phi})$	$(\dot{r}, \dot{\phi})$	$(\dot{r}, r\dot{\phi})$
3) aff. u,v syst. $ds^2 = du^2 + 2dudv + 2dv^2$ $\begin{cases} x = u + v \\ y = v \end{cases}$ e.g. $\dot{x} = 2 \dot{y} = 1$ $\dot{u} = 1 \dot{v} = 1 \rightarrow$	$(\dot{u} + \dot{v}, \dot{u} + 2\dot{v})$  $(2, 3)$	$(\dot{u} + \dot{v}, \frac{1}{\sqrt{2}}(\dot{u} + 2\dot{v}))$  $(2, \frac{3}{\sqrt{2}})$	$(\dot{u}, \dot{v})$  $(1, 1)$	$(\dot{u}, \sqrt{2}\dot{v})$  $(1, \sqrt{2})$

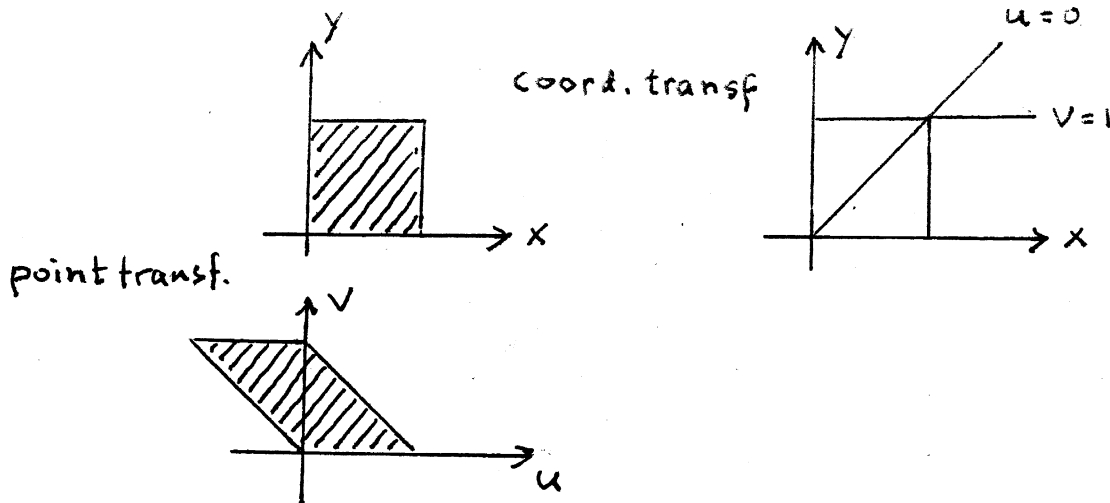
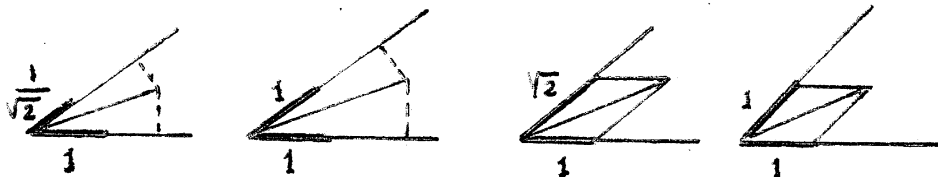

Joint calculation to the table

$$v_i = v_i = v^i = v^i = (\dot{x}, \dot{y}) \quad , \quad \text{velocity cartesian}$$

$$u^1 = x = x^1 \quad \bar{u}^1 = r$$

$$u^2 = y = x^2 \quad \bar{u}^2 = \varphi$$

$$\begin{cases} x = r \cos \varphi \\ y = r \sin \varphi \end{cases} \quad \begin{cases} \dot{x} = v_1 = v^1 = \dot{r} \cos \varphi - r \sin \varphi \dot{\varphi} \\ \dot{y} = v_2 = v^2 = \dot{r} \sin \varphi + r \cos \varphi \dot{\varphi} \end{cases}$$

$$1.) \text{ covar. } \bar{v}_i = \frac{\partial x^k}{\partial u^i} v_k \quad \left( \frac{\partial x^k}{\partial u^i} \right) = \begin{pmatrix} x_r = \cos \varphi & y_r = \sin \varphi \\ x_\varphi = -r \sin \varphi & y_\varphi = r \cos \varphi \end{pmatrix}$$

$$\bar{v}_1 = \cos \varphi (\dot{r} \cos \varphi - r \sin \varphi \dot{\varphi}) + \sin \varphi (\dot{r} \sin \varphi + r \cos \varphi \dot{\varphi}) = \dot{r}$$

$$\bar{v}_2 = -r \sin \varphi (\dots\dots\dots) + r \cos \varphi (\dots\dots\dots) = r^2 \dot{\varphi}$$

2.) nat. covar.

$\zeta$	$\zeta_r$	$\zeta_\varphi$
$r \cos \varphi$	$\cos \varphi$	$-r \sin \varphi$
$r \sin \varphi$	$\sin \varphi$	$r \cos \varphi$

$$(\bar{g}_{ik}) = (\zeta_i \zeta_k) = \begin{pmatrix} 1 & 0 \\ 0 & r^2 \end{pmatrix}$$

$$(\bar{g}^{ik}) = \begin{pmatrix} 1 & 0 \\ 0 & \frac{1}{r^2} \end{pmatrix}$$

$$\bar{v}_1 = \dot{r} \cdot \frac{1}{\sqrt{1}} = \dot{r}$$

$$\bar{v}_2 = r^2 \dot{\varphi} \frac{1}{\sqrt{r^2}} = r \dot{\varphi}$$

3.) contravariant

$$\bar{v}^1 = 1 \dot{r} + 0 r^2 \dot{\varphi} = \dot{r}$$

$$\bar{v}^2 = 0 \dot{r} + \frac{1}{r^2} r^2 \dot{\varphi} = \dot{\varphi}$$

4.) nat. contravariant

$$\bar{v}^1 = \dot{r} \sqrt{1} = \dot{r}$$

$$\bar{v}^2 = \dot{\varphi} \sqrt{r^2} = r \dot{\varphi}$$

Generalization of the first groundform to the space

$$I = ds^2 = g_{ik}(u^l) du^i du^k \quad g_{ik} = \boldsymbol{\epsilon}_i \boldsymbol{\epsilon}_k$$

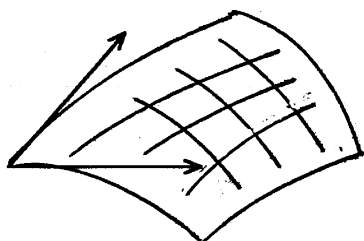

$i, k, l = 1, 2$  surfaces } Riemannian  
 $i, k, l = 1, 2, 3$  spaces  $R_3$  } spaces

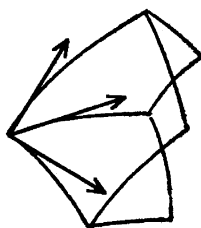

$\boldsymbol{\epsilon}(u^1, u^2)$   
 $\boldsymbol{\epsilon}(u^1, u^2, u^3)$  } position vector

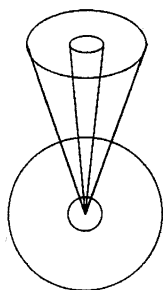

to every point  
 3 surfaces

detachment from intuition possible:  $ds^2 = f(u^l, du^l)$  Finsler's spaces

1.)  $\bar{u}^k(u^l)$  no tensor

transformation prescription for a contravariant tensor

2.)  $d\bar{u}^k = \frac{\partial \bar{u}^k}{\partial u^l} du^l$  contrav. tensor the differentials of the coordinates form a contravariant tensor

3.)  $\dot{\bar{u}}^k = \frac{\partial \bar{u}^k}{\partial u^l} \dot{u}^l$  contrav. tensor (or vector)

velocity:  $u_k = \frac{\boldsymbol{\epsilon}_k}{|\boldsymbol{\epsilon}_k|} \quad |\boldsymbol{\epsilon}_k| = \sqrt{g_{kk}}$

$$\underbrace{\omega}_{\text{vect. of velocity}} = \underbrace{\boldsymbol{\epsilon}_k}_{\text{in geom. physical sense}} \underbrace{\frac{\sqrt{g_{kk}} u_k}{J_t} \frac{\partial u^k}{\partial t}}_{\text{contrav. vect. in analytic sense}} = u_k \sqrt{g_{kk}} \dot{u}^k \quad \text{nat. contrav. comp. of physics}$$

vect. of velocity in geom. physical sense | contrav. vect. in analytic sense | nat. contrav. comp. of physics

4.)  $\ddot{\bar{u}}^k = \frac{\partial \bar{u}^k}{\partial u^l} \ddot{u}^k + \underbrace{\frac{\partial^2 \bar{u}^k}{\partial u^l \partial u^m} \dot{u}^m \dot{u}^l}_{\text{too much (disappears in cartesian coordinates)}}$  no tensor

too much  
 (disappears in cartesian coordinates)

$$\omega = \underbrace{\tau_k}_{\text{vector}} \dot{u}^k \quad \text{contra var. vect.}$$

in sense((3)) in sense((2))

$$\mathcal{b} = \frac{d\omega}{dt} = \tau_k \ddot{u}^k + \underbrace{\tau_{kj} \dot{u}^k \dot{u}^j}_{\substack{3 \cdot 3 = 9 \text{ vectors} \\ \Gamma_{ij}^k \cdot \tau_k}}$$

$$= \tau_k \underbrace{\left\{ \ddot{u}^k + \Gamma_{ij}^k \dot{u}^i \dot{u}^j \right\}}_{b^k \text{ contravariant comp. of acceleration}}$$

what signifies  $\Gamma_{ij}^k$  ?

$$\tau_{ij} \cdot \tau_l = \Gamma_{ij}^k \underbrace{\tau_k \tau_l}_{g_{kl} \text{ (in } \mathbb{R}_3)}$$

convolution

$$g_{kl} = \tau_k \tau_l \left| \cdot \frac{\partial}{\partial u^m} \right.$$

$$\frac{\partial g_{kl}}{\partial u^m} = \underbrace{\tau_{km} \tau_l}_{\Gamma_{km,l}} + \underbrace{\tau_k \tau_{lm}}_{\Gamma_{lm,k}}$$

$$\begin{array}{l|l} g_{il|j} = \Gamma_{ij,l} + \Gamma_{lj,i} & \bullet \frac{1}{2} \quad + \\ g_{ij|l} = \Gamma_{il,j} + \Gamma_{jl,i} & \bullet \frac{1}{2} \quad - \\ g_{jl|i} = \Gamma_{ji,l} + \Gamma_{li,j} & \bullet \frac{1}{2} \quad + \end{array}$$

$$\Gamma_{ij,l} = \frac{1}{2} \left( \frac{\partial g_{il}}{\partial u^j} - \frac{\partial g_{ij}}{\partial u^l} + \frac{\partial g_{jl}}{\partial u^i} \right) = \begin{bmatrix} i & j \\ l \end{bmatrix}$$

Christoffel-symbol 1st kind (no tensor)

$$\Gamma_{ij}^k = g^{kl} \Gamma_{ij,l} = \begin{Bmatrix} i & j \\ k \end{Bmatrix} \quad \text{Christoffel-symbol 2nd kind}$$

- properties: 1.) in i,j symmetric  
 2.) vanish identically for constant  $g_{ij}$   
 3.) without proof: no tensor

definition of the acceleration.

$$\frac{d\boldsymbol{\omega}}{dt} = \boldsymbol{\tau}_k \left\{ \ddot{u}^k + \Gamma_{ij}^k \dot{u}^i \dot{u}^j \right\}$$

$$b^k = \frac{\mathcal{J}^2 u^k}{\mathcal{J} t^2} \quad \text{cov. derivation or absolute deriv. of. the vect. } u^k$$

5.) gradient:

$$\underbrace{\frac{\partial \varphi(u^r(\bar{u}^s))}{\partial \bar{u}^k}}_{\bar{K}_k} = \frac{\partial u^l}{\partial \bar{u}^k} \underbrace{\frac{\partial \varphi(u^r(\bar{u}^s))}{\partial u^l}}_{K_l = \frac{\partial \varphi}{\partial u^l}} \quad \text{cov. tensor}$$

$$\bar{\lambda} = \boldsymbol{\tau}_k \cdot \lambda^k = \boldsymbol{n}_k \sqrt{g_{kk}} g^{kl} \lambda_l$$

$$\underbrace{\text{grad} \varphi}_{\text{vector in sense ((3))}} = \boldsymbol{n}_k \sqrt{g_{kk}} g^{kl} \underbrace{K_l}_{\text{cov. vector in sense ((2))}}$$

6.) momentum

$$\frac{\partial \dot{u}^l}{\partial \dot{u}^k}$$

$$\underbrace{\frac{\partial T[u^r(\bar{u}^s), \dot{u}^t]}{\partial \dot{u}^k}}_{\bar{p}_k \text{ momentum}} = \frac{\partial u^l}{\partial \dot{u}^k} \frac{\partial T[\dots]}{\partial u^l} = p_k$$

$$\frac{\partial T(u^r, u^s)}{\partial u^k} = p_k \quad (\text{momentum})$$

example

$$T = \frac{m}{2} (x^2 + y^2 + z^2) \quad \frac{\partial T}{\partial x} = mx$$

Gradient, definition:

$$\mathcal{R} = \frac{\partial \varphi}{\partial x^i}$$

NB if  $\mathcal{R}$  shall be the force, then  $\varphi$  is the physical potential with opposite sign  
covariant components:

$$K_k = \mathcal{R} \tau_k = \frac{\partial \varphi}{\partial x^i} \frac{\partial x^i}{\partial u^k} = \frac{\partial \varphi}{\partial u^k}.$$

contravariant components:

$$K^k = g^{kl} K_l$$

$$\mathcal{R} = \tau_k K^k = \tau_k g^{kl} K_l = \tau_k \sqrt{g_{kk}} g^{kl} K_l$$

example: Coulomb potential

$$\varphi = \frac{A}{r}$$

$$u^1 = r \quad u^2 = \vartheta \quad u^3 = \phi$$

$$K_1 = \frac{\partial \varphi}{\partial r} = -\frac{A}{r^2} \quad K_2 = \frac{\partial \varphi}{\partial \vartheta} = 0 \quad K_3 = \frac{\partial \varphi}{\partial \phi} = 0$$

$$\mathcal{R} = \tau_1 \sqrt{g_{11}} g^{11} K_1 = -\tau_1 \frac{A}{r^2}$$

3 Vector notions [1] algebraic [2] analytic [3] physical

$$\mathbf{w} = \underbrace{\boldsymbol{\zeta}_k}_{[3]} \underbrace{\dot{u}^k}_{[2]} = w_k \underbrace{\sqrt{g_{kk}}}_{(\omega)} \dot{u}^k$$

$$w_k = \frac{\zeta_k}{\sqrt{g_{kk}}}$$

$$u^i(\bar{u}^k)$$

is a admissible transformation if

1. inversion unique
2. continuous
3. at least once continuously derivable

Note 1: variation calculus

$$\rho_i = -\frac{d}{dt} F_{u^i}(u^j(t), \dot{u}^j) + F_{u^i} \quad \text{gradient in function space}$$

Note 2 : Hamilton's theory

$$\begin{cases} \sigma^i = q^i - H_{p_i} \\ \tau_i = p_i + H_{q_i} \end{cases}$$

Examples for tensors and transformation properties

1.) metric tensor

$$\alpha) \quad g_{kl} = \frac{\partial x^j}{\partial u^k} \frac{\partial x^j}{\partial u^l} = \boldsymbol{\zeta}_k \boldsymbol{\zeta}_l \quad \text{symmetric} \quad g_{kl} = g_{lk}$$

$$I = ds^2 = g_{kl} du^k du^l = \bar{g}_{kl} d\bar{u}^k d\bar{u}^l \quad \text{invariant (due to its geometric significance)}$$

$$\underbrace{\bar{g}_{mn}}_{\substack{\partial x^j \\ \partial \bar{u}^m}} \frac{\partial \bar{u}^m}{\partial u^k} \cdot \frac{\partial \bar{u}^n}{\partial u^l} = \frac{\partial x^j}{\partial u^k} \cdot \frac{\partial x^j}{\partial u^l} = g_{kl}$$

$\frac{\partial x^j}{\partial \bar{u}^m} \cdot \frac{\partial x^j}{\partial \bar{u}^n}$  from definition

$$\beta) \underbrace{g^{kl} \lambda_l}_{\lambda^k} u_k = \lambda^k \mu_k \quad \text{invariant!} \quad g^{kl} \quad \text{tensor}$$

$$\text{is it symmetric as well? } g^{kl} = \left\{ \text{alg. compl.} \cdot \frac{1}{g} (-1)^{k+1} \left( \begin{array}{c} \dots\dots\dots \\ \dots g_{kl} \dots \end{array} \right) \right\}$$

symm.!

$$\gamma) g^{kl} g_{lm} = \delta_k^m = g_{\bullet m}^k = g_k^m \quad \boxed{g_m^k = \delta_m^k}$$

↪ hence tensor

$$\left. \begin{array}{l} g^{kl} b_{lm} = c_{\bullet m}^k \\ \text{symm.} \\ g^{kl} b_{ml} = c_m^{\bullet k} \end{array} \right\} = c_k^m$$

from the symmetry of the  $b_{lm}$  follows the symmetry of the  $c_m^k$

from  $c_{\bullet m}^k = c_m^{\bullet k} = c_m^k$  does not follow  $b_{lm} = b_{ml}$

example

$$\underbrace{\begin{pmatrix} 0 & 0 \\ 0 & 1 \end{pmatrix}}_{g^{kl}} \underbrace{\begin{pmatrix} 1 & 1 \\ 1 & 1 \end{pmatrix}}_{a_{lm}} = \underbrace{\begin{pmatrix} 0 & 0 \\ 1 & 1 \end{pmatrix}}_{c_{\bullet m}^k} \qquad \underbrace{\begin{pmatrix} 0 & 0 \\ 0 & 1 \end{pmatrix}}_{g^{kl}} \underbrace{\begin{pmatrix} 0 & 0 \\ 1 & 1 \end{pmatrix}}_{b_{ml}} = \underbrace{\begin{pmatrix} 0 & 0 \\ 1 & 1 \end{pmatrix}}_{c_m^{\bullet k}}$$

((1)) algebraic vector = number - n - multiple

((2)) analytic vector = number- n -multiple +transformation prescription

(cov. and *contra*var.vectors)

((3)) geometric physical vector (only in Riemannian space)



$$g_{ik}, g^{ik}, g_i^k = \delta_i^k \rightarrow \underbrace{g_k^k = n}_{\neq g \text{ (incoherence!)}} |g_{ik}|$$

$$\delta.) g_{kl} = \bar{g}_{mn} \frac{\partial \bar{u}^m}{\partial u^n} \frac{\partial \bar{u}^n}{\partial u^l}$$

$$\begin{vmatrix} a_{11} & a_{12} \\ a_{21} & a_{22} \end{vmatrix} \begin{vmatrix} b_{11} & b_{12} \\ b_{21} & b_{22} \end{vmatrix} = \begin{vmatrix} a_{11}b_{11} + a_{12}b_{21} & a_{11}b_{12} + a_{12}b_{22} \\ a_{21}b_{11} + a_{22}b_{21} & a_{21}b_{12} + a_{22}b_{22} \end{vmatrix}$$

$$|a_{iv}| \cdot |b_{vk}| = |a_{iv} b_{vk}|$$

(not smm!) (summ!)

$$|A| \cdot |B| = |A \cdot B|$$

$$|a_{iv}| |b_{v\mu}| |c_{\mu k}| = |a_{iv} b_{v\mu} c_{\mu k}|$$

$$|g_{kl}| = |\dots\dots\dots| = |\bar{g}_{mn}| \cdot \left| \frac{\partial \bar{u}^m}{\partial u^k} \right| \left| \frac{\partial \bar{u}^n}{\partial u^l} \right|$$

$$g = \bar{g} \bullet \Phi^2(u^l) \quad \text{functional. det er min ant} = \Phi(u^l)$$

no absolute and no relative invariant

for aff.tr. → rel.inv. for proper orth.tr. → abs.inv.

proj. tr. (k,.....=1,.....,n)

$$\bar{u}^m = \frac{\alpha_{mk} u^k + \alpha_{m,n+1}}{\alpha_{n+1,k} u^k + \alpha_{n+1,n+1}} \quad ; \quad \text{Det} \begin{vmatrix} \alpha_{11} \dots \dots \dots \alpha_{1,n+1} \\ \dots\dots\dots \\ \dots\dots\dots \\ \dots\dots\dots \end{vmatrix}$$

affine tr.

$$\bar{u}^m = \alpha_{mk} u^k + \alpha_{m,n+1}$$

for  $\alpha_{m,n+1} \equiv 0$  centroaffine transf.

orth. transf.

$$\bar{u}^m = \alpha_{mk} u^k + \alpha_{m,n+1}, \quad \alpha_{mk} \alpha_{ml} = \delta_{kl} \text{ without proof}$$

for  $\text{Det} \begin{vmatrix} \alpha_{11} \dots\dots\dots \\ \dots\dots\dots \alpha_{mn} \end{vmatrix} = +1$  proper orthogonal transf.

orientation is conserved

$$\left. \begin{aligned} \frac{\partial \bar{u}^m}{\partial u^k} &= \alpha_{mk} \\ \frac{\partial^2 \bar{u}^m}{\partial u^k \partial u^l} &= 0 \end{aligned} \right\}$$

**EX10** Are the admissible transformations forming a group?

- $\bar{u}^m(u^l)$  1.) inversion uniqueness  
2.) continuous and continuously derivable

2.) Main tensor

$$\alpha.) \quad b_{kl} = v_i \frac{\partial^2 x^i}{\partial u^k \partial u^l}$$

$\nearrow b_{kl} du^k du^l$  hence  $b_{kl}$  Tensor

$$\frac{\Pi}{I} = \frac{1}{\rho} \cos \alpha \quad I \text{ is invariant}$$

$b_{kl}$  tensor, symmetric

$$\beta.) \quad b_{kl} g^{kn} g^{lm} = b^{nm} \quad \text{tensor, symmetric}$$

$$\gamma.) \quad a_{ni} \cdot \tilde{a}^{im} = \delta_n^m \quad \text{so defined}$$

$$a_{kl} g^{kn} g^{lm} = a^{nm}$$

**EX11** Verify the following relation:

$$\tilde{a}^{kl} \cdot \frac{|a_{kl}|}{|g_{kl}|} + a^{kl} = g^{kl} \cdot (g^{ij} \cdot a_{ij})$$

An appropriate linear combination is prop. to the twofold contravariant fundamental tensor

pecial case:  $a_{ik} \equiv g_{ik}$

$$\tilde{g}^{kl} + g^{kl} = g^{kl} \underbrace{(g^{ij} g_{ij})}_{\delta_i^i = 2} \quad \text{if we consider a surface in space}$$

$$\boxed{\tilde{g}^{kl} = g^{kl}}$$

δ.)  $b_{kl}g^{kn} = b_{\bullet l}^n = b_l^n$  in general not symmetric!  
 symmetry of the  $b_{kl}$

ε.)  $b_k^k = \bar{b}_n^n = 2H$  no mination  
 $\neq b = |b_{kl}|$

$$\boxed{b = \bar{b}\Phi^2} \quad \Phi = \left| \frac{\partial \bar{u}^m}{\partial u^i} \right|$$

in the  $R_3$

$$\boxed{K = |b_l^k| = |b_{nl} \cdot g^{nk}| = |b_{nl}| \cdot |g^{nk}| = b \cdot \frac{1}{g} = \frac{\bar{b}\Phi^2}{\bar{g}\Phi^2} = \frac{\bar{b}}{\bar{g}}} \quad \text{we call it } K$$

abs. inv.

intercalation

$$g_{ik}g^{kl} = \delta_i^l \quad \underbrace{|g_{ik}|}_{g} \cdot \underbrace{|g^{kl}|}_{\frac{1}{g}} = \underbrace{|\delta_i^l|}_1 \quad |g^{kl}| = \frac{1}{g}$$

3.)  $\frac{\partial u^i}{\partial \bar{u}^k}$   $\rho_{ik} = \frac{\partial \bar{u}^i}{\partial u^k}(u^l)$

1st conception:  $u^l(\bar{u}^m)$

$$\bar{\rho}_{ik} = \frac{\partial \bar{u}^i}{\partial u^k}(\bar{u}^m)$$

no tensor!

2nd conception:

$$\bar{\rho}_{ik} = \frac{\partial \bar{u}^i}{\partial \bar{u}^k} (= \delta_{ki})$$

$$\bar{\bar{\rho}}_{ik} = \frac{\partial \bar{u}^i}{\partial \bar{\bar{u}}^k} =$$

$$\underbrace{\frac{\partial \bar{u}^i}{\partial u^k}}_{\rho_{(i)k}} = \frac{\partial \bar{u}^i}{\partial \bar{u}^l} \frac{\partial \bar{u}^l}{\partial u^k} \quad \text{for each fixed } i \text{ cov. 1st rank tensor}$$

$$\rho_{(i)k} \quad \bar{\rho}_{(i)l}$$

kept fixed, then cov. vector

4.)  $\delta_{kl} \bullet \xi^k \eta^l = \xi^k \eta^k$  in general not invariant

no tensor

$$\delta_k^l = \text{tensor}$$

$$g_{il} \delta_k^i = \underbrace{\delta_{lk}}_{g_{kl} \text{ for } i=k}$$

5.)

$$\varepsilon_{ikl} = \begin{cases} 1 \text{ for. pair perm.} \\ -1 \text{ for. impair perm} \\ 0 \text{ otherwise.} \end{cases}$$

functional determinant

$$\varepsilon_{ikl} = \bar{\varepsilon}_{pqr} \frac{\frac{\partial \bar{u}^p}{\partial u^i} \frac{\partial \bar{u}^q}{\partial u^k} \frac{\partial \bar{u}^r}{\partial u^l}}{\frac{\partial(\bar{u}^1 \bar{u}^2 \bar{u}^3)}{\partial(u^i, u^k, u^l)}} = \begin{cases} \Phi(u^m) \text{ for pair perm. } ikl \\ -\Phi(u^m) \text{ for impair perm. } ikl \\ 0 \text{ otherwise} \end{cases}$$

$$= \begin{cases} 1 \text{ for pair perm.} \\ -1 \text{ for impair perm.} \\ 0 \text{ otherwise} \end{cases} \quad \text{for proper orthogonal transformations.}$$

**EX12** Prove that  $\varepsilon_{ikl} \sqrt{g}$  tensor!

functional determinant

$$\Phi(u^m) = \begin{vmatrix} \frac{\partial \bar{u}^1}{\partial u^1} & \frac{\partial \bar{u}^1}{\partial u^2} & \frac{\partial \bar{u}^1}{\partial u^3} \\ \frac{\partial \bar{u}^2}{\partial u^1} & \frac{\partial \bar{u}^2}{\partial u^2} & \frac{\partial \bar{u}^2}{\partial u^3} \\ \frac{\partial \bar{u}^3}{\partial u^1} & \frac{\partial \bar{u}^3}{\partial u^2} & \frac{\partial \bar{u}^3}{\partial u^3} \\ \vdots & \vdots & \vdots \\ \frac{\partial \bar{u}^i}{\partial u^1} & \frac{\partial \bar{u}^i}{\partial u^2} & \frac{\partial \bar{u}^i}{\partial u^3} \\ \vdots & \vdots & \vdots \\ \frac{\partial \bar{u}^k}{\partial u^1} & \frac{\partial \bar{u}^k}{\partial u^2} & \frac{\partial \bar{u}^k}{\partial u^3} \\ \vdots & \vdots & \vdots \\ \frac{\partial \bar{u}^l}{\partial u^1} & \frac{\partial \bar{u}^l}{\partial u^2} & \frac{\partial \bar{u}^l}{\partial u^3} \end{vmatrix} = \frac{\partial(\bar{u}^1 \bar{u}^2 \bar{u}^3)}{\partial(u^1 u^2 u^3)}$$

permutation of the indices  $i, k, l$  = permutation of columns

equal indices: equal columns  $\det = 0$

$$g_k^k = \delta_k^k = n \neq g$$

$$\delta_k^k = 1$$

$$\left. \begin{array}{l} b_k^k = 2H \\ \frac{b}{g} = K \end{array} \right\} R_3$$

**EX13**

$$(\varepsilon_{kl}) = \sqrt{g} \begin{pmatrix} 0 & 1 \\ -1 & 0 \end{pmatrix} = \begin{pmatrix} 0 & \sqrt{g} \\ -\sqrt{g} & 0 \end{pmatrix}$$

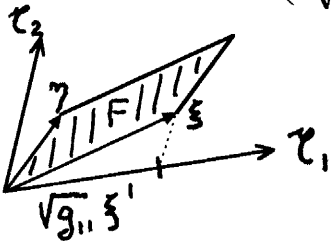

Represent the surface by using the contravariant components of  $\xi, \eta$  and the quantity  $\varepsilon_{kl}$

$$F = \dots = \varepsilon_{kl} \xi^k \eta^l \text{ geom. invariant}$$

**EX14**

$$\Gamma_{jk,l} = \frac{1}{2} \left\{ \frac{\partial g_{jl}}{\partial u^k} + \frac{\partial g_{kl}}{\partial u^j} - \frac{\partial g_{jk}}{\partial u^l} \right\} = \Gamma_{kl}^m g_{mj} = \begin{bmatrix} k & l \\ m \end{bmatrix} \text{ 1st kind}$$

$$\Gamma_{kl}^j = g^{mj} \Gamma_{kl,m} = \begin{bmatrix} k & l \\ j \end{bmatrix} \text{ 2nd kind}$$

derive the transformation prescription!

$$g_{jl} = \dots \cdot \bar{g}_{pq} \left| \frac{\partial}{\partial u^k} \right.$$

$$\bar{\Gamma}_{pq,r} = \frac{\partial u^j}{\partial \bar{u}^p} \cdot \frac{\partial u^k}{\partial \bar{u}^q} \cdot \frac{\partial u^l}{\partial \bar{u}^r} \Gamma_{jk,l} + \frac{\partial u^j}{\partial \bar{u}^r} \cdot \underbrace{\frac{\partial^2 u^k}{\partial \bar{u}^p \partial \bar{u}^q}}_{=0} \cdot g_{jk}$$

= 0 for affine transformations

affine tensor

$$\bar{\Gamma}_{pq}^s = \frac{\partial u^j}{\partial \bar{u}^p} \frac{\partial u^k}{\partial \bar{u}^q} \frac{\partial \bar{u}^s}{\partial u^n} \cdot \Gamma_{jk}^n + \frac{\partial^2 u^k}{\partial \bar{u}^p \partial \bar{u}^q} \cdot \frac{\partial \bar{u}^s}{\partial u^k}$$

§9. The covariant (absolute) derivation:

Example

$$\frac{\mathcal{J} a_v^{\bullet \mu}}{\mathcal{J} u^k} = \frac{\partial a_v^{\bullet \mu}}{\partial u^k} - \Gamma_{vk}^i a_i^{\bullet \mu} + \Gamma_{ik}^{\mu} a_v^{\bullet i}$$

$$\frac{\mathcal{J} a_v^{\bullet \mu \rho}}{\mathcal{J} u^k} = \frac{\partial a_v^{\bullet \mu \rho}}{\partial u^k} - \Gamma_{vk}^i a_i^{\bullet \mu \rho} + \Gamma_{ik}^{\mu} a_v^{\bullet i \rho} + \Gamma_{ik}^{\rho} a_v^{\bullet \mu i}$$

$a_v^{\bullet 00}$        $a_0^{\bullet \mu 0}$        $a_0^{\bullet 0 \rho}$

$$a_v^{\bullet \mu} \parallel_k \quad a_v^{\bullet \mu} |_k$$

abbreviations

$$\mathcal{J} a_v^{\bullet \mu} = da_v^{\bullet \mu} - \left\{ \Gamma_{vk}^i a_i^{\bullet \mu} - \Gamma_{ik}^{\mu} a_v^{\bullet i} \right\} du^k$$

Examples

$$1.) \quad \frac{\mathcal{J} a}{\mathcal{J} u^k} = \frac{\partial a}{\partial u^k} \qquad \frac{\mathcal{J} x^j}{\mathcal{J} u^k} = \frac{\partial x^j}{\partial u^k}$$

cov.

$$\frac{\mathcal{J} u^j}{\mathcal{J} t} = \frac{\partial u^j}{\partial t} = \frac{du^j}{dt}$$

contrav.

$$2.) \quad \frac{\mathcal{J} a_v}{\mathcal{J} u^k} = \frac{\partial a_v}{\partial u^k} - \Gamma_{vk}^i a_i$$

$$3.) \quad \frac{\mathcal{J} a^v}{\mathcal{J} u^k} = \frac{\partial a^v}{\partial u^k} + \Gamma_{ik}^v a^i$$

$$\frac{\mathcal{D}^2 u^j}{\mathcal{D}t^2} = \frac{d^2 u^j}{dt^2} + \Gamma_{ik}^j \dot{u}^i \dot{u}^k$$

From

$$\mathcal{D}\dot{u}^j = d\dot{u}^j + \Gamma_{ik}^j \dot{u}^i du^k$$

clarifying an apparent contradiction

$$\frac{\mathcal{D}x^j}{\mathcal{D}u^k} = \frac{\partial x^j}{\partial u^k} \quad \text{cov.} \quad \frac{\partial x^j}{\partial u^k} = \frac{\partial x^j}{\partial \bar{u}^1} \cdot \frac{\partial \bar{u}^1}{\partial u^k} \quad \text{cov.}$$

$$\frac{\mathcal{D}u^j}{\mathcal{D}t} = \frac{du^j}{dt} \quad \text{contrav.} \quad \frac{du^j}{dt} = \frac{\partial u^j}{\partial \bar{u}^1} \cdot \frac{d\bar{u}^1}{dt} \quad \text{contrav.}$$

Derivation rules

$$1.) \quad g_{ik|l} = \frac{\mathcal{D}g_{ik}}{\mathcal{D}u^l} = g_{ik|l} - \underbrace{\Gamma_{il}^m \cdot g_{mk}}_{\Gamma_{il,k}} - \underbrace{\Gamma_{kl}^m \cdot g_{im}}_{\Gamma_{kl,i}} = 0$$

$$\frac{1}{2} (g_{ik|l} + g_{lk|i} - g_{il|k}) \quad \frac{1}{2} (g_{ki|l} + g_{li|k} - g_{kl|i})$$

$$\boxed{\frac{\mathcal{D}g_{ik}}{\mathcal{D}u^l} = \frac{\partial g_{ik}}{\partial u^l} - \Gamma_{il,k} - \Gamma_{kl,i} = 0}$$

Ricci's theorem: the fundamental tensor plays the same role as that of a constant.

General: the cov. derivative plays the same role in Riemannian space as that of the ordinary derivative in Euklidian space. simulating Euklidian space.

2.) sum rule

$$\left( a_{\bullet\bullet} \pm b_{\bullet\bullet} \right)_{|k} = \underbrace{c_{\bullet\bullet|k}}_{a_{\bullet\bullet|k} \pm b_{\bullet\bullet|k}} - \sum \Gamma_{\bullet\bullet}^{\bullet} \underbrace{c_{\bullet\bullet}}_{a_{\bullet\bullet} \pm b_{\bullet\bullet}} + \sum \Gamma_{\bullet\bullet}^{\bullet} \underbrace{c_{\bullet\bullet}}_{a_{\bullet\bullet} \pm b_{\bullet\bullet}} = a_{\bullet\bullet|k} \pm b_{\bullet\bullet|k}$$

for tensors of the same type

3.) product rule:

$$\left( a_{\mu} b^{\nu} \right)_{|k} = a_{\mu|k} b^{\nu} + a_{\mu} b^{\nu}_{|k} - \underbrace{\Gamma_{\mu k}^i a_i}_{c_i^{\nu}} b^{\nu} + \Gamma_{ik}^{\nu} \underbrace{a_{\mu}}_{c_{\mu}^i} b^i$$

$$= \left( a_{\mu|k} - \Gamma_{\mu k}^i a_i \right) b^{\nu} + a_{\mu} \left( b^{\nu}_{|k} + \Gamma_{ik}^{\nu} b^i \right)$$

$$\boxed{(a_\mu b^\nu)_{||k} = a_{\mu||k} b^\nu + a_\mu b^\nu_{||k}}$$

$$(a_{\bullet\bullet} b_{\bullet\bullet})_{||k} = a_{\bullet\bullet||k} b_{\bullet\bullet} + a_{\bullet\bullet} b_{\bullet\bullet||k}$$

$$4.) (g_{ik} \bullet b_{\bullet\bullet})_{||l} = g_{ik} \bullet b_{\bullet\bullet||l}$$

$$5.) \delta_{j||l}^i = \underbrace{\delta_{j||l}^i}_0 - \underbrace{\Gamma_{jl}^m \delta_m^i}_{\Gamma_{jl}^i} + \underbrace{\Gamma_{ml}^i \delta_j^m}_{\Gamma_{jl}^i} = 0$$

to be derived also from  $\delta_j^i = g_j^i$

Statement:

the covariant derivation yields again a tensor

proof for contravariant vector

abbreviations

$$\bar{a}_{||i}^j = \bar{a}_{|i}^j + \bar{\Gamma}_{kl}^j \bar{a}^k$$

$$\frac{\mathcal{J} \bar{a}^j}{\mathcal{J} \bar{u}^l} = \bar{a}_{||i}^j$$

$$\frac{\partial u^j}{\partial \bar{u}^k} = u_{|k}^j$$

$$\frac{\partial \bar{u}^j}{\partial u^k} = \bar{u}_{|k}^j$$

$$= \underbrace{\left( \bar{u}_{|m}^j a^m \right)_{|i}}_{\bar{u}_{|mn}^j \cdot u_{|i}^n \cdot a^m + \bar{u}_{|m}^j \cdot a_{|n}^m \cdot u_{|i}^n} + \left( \underbrace{u_{|k}^p \cdot u_{|i}^n \cdot \bar{u}_{|m}^j \cdot \Gamma_{mn}^p \cdot \bar{u}_{|r}^k a^r}_{+ u_{|k}^m \cdot \bar{u}_{|i}^j \cdot \bar{u}_{|r}^k a^r} \right) = \delta_r^p$$

$$u_{|i}^n \cdot \bar{u}_{|m}^j \Gamma_{pn}^m a^p$$

$$= \bar{u}_{|mn}^j \cdot u_{|i}^n \left\{ \underbrace{a_{|n}^m + \Gamma_{pn}^m \cdot a^p} \right\} + \bar{u}_{|r}^j \cdot u_{|i}^n \cdot a_{|r}^n$$

p and m interchanged (dummy indices)

$$+ u_{|k}^m \cdot \bar{u}_{|i}^j \cdot \bar{u}_{|r}^k \cdot a^r$$

$$\bar{u}_{|m}^j \cdot u_{|i}^n \cdot a_{|n}^m + a^r \left\{ \bar{u}_{|nr}^j u_{|i}^n + u_{|i}^n \bar{u}_{|nr}^j \right\}$$

$$u_{|k}^n \bar{u}_{|r}^k = u_{|r}^n$$

$$\underbrace{\left( \bar{u}_{|n}^j u_{|i}^n \right)_{|r}} = 0 \quad \delta_i^j$$



$$\boxed{\bar{a}_{||i}^j = \frac{\partial \bar{u}^j}{\partial u^m} \bullet \frac{\partial u^n}{\partial \bar{u}^l} \bullet a_{||n}^m}$$

**EX15** The same for 1st rank covariant tensor

Without proof (reporting) the following

remarks

I.  $\varphi_{||k} = \varphi_{|k}$                       gradient

$a_{\bullet\bullet||k}$                       (grad. of a tensor)

II.  $a_{||i}^i = g^{ik} \bullet a_{||k}$               divergence

III. (orthogonal coordinates in the  $R_3$  )

$\varepsilon_{ijk} g^{jp} a_{||p}^k$                       curl

some authors understand  $\varepsilon_{ijk} = \begin{cases} \sqrt{g} & \text{f. pair. perm.} \\ -\sqrt{g} & \text{f. impair perm.} \\ 0 & \text{otherwise} \end{cases}$

IV.  $\Delta\varphi = g^{ij}\varphi_{||ij}$               Laplace

$a_{i||kj} - a_{i||jk} = \underbrace{R_{ijk}^l}_{\text{Riemann's curvature tensor}} \bullet a_l$

$$\Gamma_{ik|j}^l - \Gamma_{ij|k}^l - \Gamma_{mk}^l \Gamma_{ij}^m + \Gamma_{mj}^l \Gamma_{ik}^m$$

V.  $\frac{\mathcal{J}^2 u^i}{\mathcal{J} s^2} = 0$               differential equation of the geodesic lines

## § 10. Example from elasticity theory

Deformation tensor

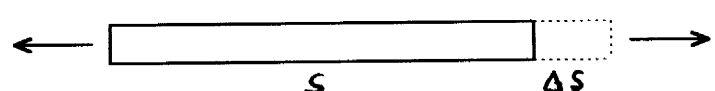
1.)   $\epsilon = \frac{\Delta s}{s}$  stretching

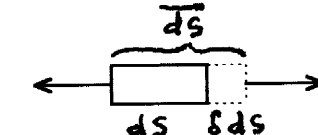
2.)   $\epsilon = \frac{\delta ds}{ds}$   $2ds\delta ds = 2ds^2\epsilon$

$$\bar{ds}^2 = (ds + \delta ds)^2 = ds^2 + 2ds\delta ds + \underbrace{(\delta ds)^2}_{\substack{ds^2\epsilon \\ \text{neglect}}} = ds^2(1 + 2\epsilon)$$

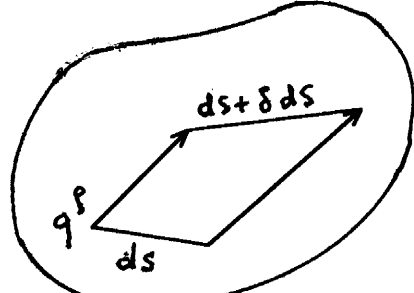
3.)   $v^\rho$  small  $\frac{\partial v^\rho}{\partial q^\mu}$  small

before deformation:

$$ds^2 = g_{\rho\sigma}(q^\lambda) dq^\rho dq^\sigma$$

partial space  
not  $T_2$  in the  $R_3$  but  $T_3$  in the  $R_3$

$$\rho, \sigma, \lambda = 1, 2, 3$$

after deformation:

$$\begin{aligned} \bar{ds}^2 &= (ds + \delta ds)^2 = g_{\rho\sigma}(q^\lambda + v^\lambda) (dq^\rho + dv^\rho) (dq^\sigma + dv^\sigma) \\ &= \left\{ g_{\rho\sigma}(q^\lambda) + \frac{\partial g_{\rho\sigma}}{\partial q^\lambda}(q^\lambda) v^\lambda + \dots \right\} \left\{ dq^\rho + \frac{\partial v^\rho}{\partial q^\mu} dq^\mu \right\} \left\{ dq^\sigma + \frac{\partial v^\sigma}{\partial q^\nu} dq^\nu \right\} \\ &= g_{\rho\sigma}(q^\lambda) dq^\rho dq^\sigma + \underbrace{g_{\rho\sigma} \left( dq^\rho \frac{\partial v^\sigma}{\partial q^\nu} dq^\nu + \frac{\partial v^\rho}{\partial q^\mu} dq^\mu dq^\sigma + \dots \right)}_{2ds\delta ds} + \frac{\partial g_{\rho\sigma}}{\partial q^\lambda} v^\lambda dq^\rho dq^\sigma = ds^2 + 2ds\delta ds + \text{terms of higher order} \end{aligned}$$

$$\begin{aligned} 2ds\delta ds &= dq^\rho dq^\sigma \left\{ g_{\rho\nu} \frac{\partial v^\nu}{\partial q^\sigma} + g_{\mu\sigma} \frac{\partial v^\mu}{\partial q^\rho} + \frac{\partial g_{\rho\sigma}}{\partial q^\lambda} v^\lambda \right\} \\ &= \underbrace{2\varepsilon_{\rho\sigma}}_{\substack{\text{definition} \\ = \Gamma_{\rho\lambda, \sigma} + \Gamma_{\sigma\lambda, \rho}}} \text{ see next page} \end{aligned}$$

Ricci's theorem

convolution of the Christoffel-Symbol of second kind with  
the fundamental tensor

$$\begin{aligned} \frac{\mathfrak{J} g_{\rho\sigma}}{\mathfrak{J} q^\lambda} = 0 &= \frac{\partial g_{\rho\sigma}}{\partial q^\lambda} - \Gamma_{\rho\lambda,\sigma} - \Gamma_{\sigma\lambda,\rho} \\ 2\varepsilon_{\rho\sigma} &= \underbrace{\Gamma_{\rho\lambda,\sigma} \cdot v^\lambda}_{\Gamma_{\rho\lambda}^\mu g_{\mu\sigma}} + \underbrace{\Gamma_{\sigma\lambda,\rho} \cdot v^\lambda}_{\Gamma_{\sigma\lambda}^\nu g_{\nu\rho}} + g_{\mu\sigma} \frac{\partial v^\mu}{\partial q^\rho} + g_{\rho\nu} \frac{\partial v^\nu}{\partial q^\sigma} \\ &= g_{\mu\sigma} \underbrace{\left( \frac{\partial v^\mu}{\partial q^\rho} + \Gamma_{\rho\lambda}^\mu v^\lambda \right)}_{\frac{\mathfrak{J} v^\mu}{\mathfrak{J} q^\rho}} + g_{\rho\nu} \underbrace{\left( \frac{\partial v^\nu}{\partial q^\sigma} + \Gamma_{\sigma\lambda}^\nu v^\lambda \right)}_{\frac{\mathfrak{J} v^\nu}{\mathfrak{J} q^\sigma}} \\ &= \frac{\mathfrak{J} (g_{\mu\sigma} v^\mu)}{\mathfrak{J} q^\rho} + \frac{\mathfrak{J} (g_{\rho\nu} v^\nu)}{\mathfrak{J} q^\sigma} \\ \boxed{\varepsilon_{\rho\sigma} = \frac{1}{2} \left( \frac{\mathfrak{J} v_\sigma}{\mathfrak{J} q^\rho} + \frac{\mathfrak{J} v_\rho}{\mathfrak{J} q^\sigma} \right) = \frac{1}{2} (v_{\sigma||\rho} + v_{\rho||\sigma})} \end{aligned}$$

**EX16** Specializing for

- 1.) cartesian coordinates
- 2.) cylinder coordinates
- 3.) spherical coordinates

( in the form of a matrix)

---

$$s^{\mu\nu} = C^{\mu\nu\rho\sigma} \varepsilon_{\rho\sigma}$$

## §11. Geodesic lines

$$\int_{s_0}^{s_1} ds = \int_{t_0}^{t_1} \dot{s} dt = \int_{t_0}^{t_1} \sqrt{g_{kl} \dot{u}^k \dot{u}^l} dt = \text{Min!}$$

Variation problem

$$\mathfrak{J} = \int_{t_0}^{t_1} F(t, u(t), \dot{u}(t)) dt = \text{Min!}$$

$$u(t_0) = u(t_1)$$

$$u(t) = U(t) + \varepsilon \eta(t) \quad \eta(t_0) = \eta(t_1) = 0$$

$$\mathfrak{J} = \int_{t_0}^{t_1} F(t, U(t) + \varepsilon \eta(t), \dot{U}(t) + \varepsilon \dot{\eta}(t)) dt = \text{Min!}$$

$$\frac{d\mathfrak{J}}{d\varepsilon}(\varepsilon) = \int_{t_0}^{t_1} (F_u \eta + F_{\dot{u}} \dot{\eta}) dt = \underbrace{[\eta(t) F_{\dot{u}}]}_{=0} \Big|_{t_0}^{t_1} + \int \eta \left[ F_u - \frac{d}{dt} F_{\dot{u}} \right] dt = 0$$

$F_u - \frac{d}{dt} F_{\dot{u}} = 0$	necessary condition
--------------------------------------	---------------------

$$\int_{t_0}^{t_1} F^N(t, u^k, \dot{u}^k) dt = \text{Min!}$$

$\cancel{F}^{N-1} \bullet F_{u^k} - \frac{d}{dt} (\cancel{F}^{N-1} F_{\dot{u}^k}) = 0$
--

statement

$$\dot{s} \rightarrow \dot{s}^2 \quad \text{if } t \text{ is replaced by } s \text{ after the variation}$$

$$\sqrt{g_{kl} u'^k u'^l} = \frac{ds}{ds} = 1$$

$$F = \left[ g_{kl} \dot{u}^k \dot{u}^l \right]_{t=s} \rightarrow F_{u^k} - \frac{d}{dt} F_{\dot{u}^k} \Big|_{t=s} = 0$$

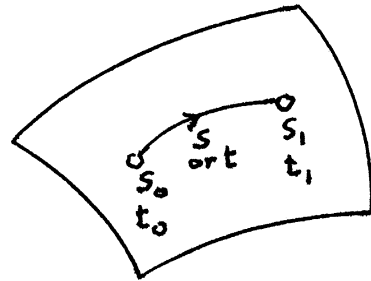

$$\left[ \int_{t_0}^{t_1} \dot{s}^2 dt \right] = \text{Min!} \quad \text{after the variation } t \rightarrow s$$

Euler:

$$0 = \frac{d}{dt} \left( \underbrace{g_{ij} \dot{u}^i \dot{u}^j}_{\dot{u}^k} \right) - \left( \underbrace{g_{ij} \dot{u}^i \dot{u}^j}_{u^k} \right) \Big|_{t=s} =$$

$$\frac{d}{dt} (2g_{kj} \dot{u}^j) - g_{ijk} \dot{u}^i \dot{u}^j$$

$$\underbrace{2g_{kji} \ddot{u}^j + 2g_{kj} \ddot{u}^j}_{g_{jk|i} \dot{u}^i \dot{u}^j + g_{ik|j} \dot{u}^j \dot{u}^i}$$

$$= 2g_{kj} \ddot{u}^j + \underbrace{(g_{jk|i} + g_{ik|j} - g_{ijk}) \dot{u}^i \dot{u}^j}_{2\Gamma_{ij,k}} \Big|_{t=s} = 0$$

$$\text{convolution } g^{kn} \Big| \bullet \frac{1}{2}$$

$$\ddot{u}^n + \Gamma_{ij}^n \dot{u}^i \dot{u}^j \Big|_{t=s} = 0$$

$$\boxed{u''^n + \Gamma_{ij}^n u'^i u'^j = 0}$$

differential equation of the geodesic lines

system of differential equations.

or

$$\boxed{\frac{\mathfrak{D}^2 u^n}{\mathfrak{D} s^2} = 0}$$

$$\overset{\circ}{\circ} x = 0 \rightarrow x = \alpha s + \beta$$

$$\overset{\circ}{\circ} y = 0 \rightarrow y = \gamma s + \delta$$

$$y = a x + b$$

the absolute differential calculus simulates Euklidian situations

## 1.) Example

special isotherm parameters

$$ds^2 = \underbrace{[f(u) + h(v)]}_E (du^2 + dv^2) \quad \text{Liouville-surfaces e.g. all rotation surfaces}$$

For L-surfaces indicate the geod. lines in such a way that only quadratures remain necessary.

$$\left[ \int E(\dot{u}^2 + \dot{v}^2) dt \right]_{t=s} \quad \text{Min!} \quad u, v \text{ symm.}$$

$$\textcircled{I} \quad \frac{d}{ds}(2Eu') - \overset{\circ}{f}(u'^2 + v'^2) = 0 \quad \left| \begin{array}{l} \circ = \frac{d}{du} \\ * = \frac{d}{dv} \end{array} \right.$$

$$\textcircled{II} \quad u \leftrightarrow v$$

$$\textcircled{I} \quad u'' + \underbrace{\frac{\overset{\circ}{f}}{2E}}_{\Gamma_{11}^1} u'^2 + 2 \underbrace{\frac{\overset{*}{h}}{2E}}_{\Gamma_{12}^1} u'v' + \underbrace{\frac{-\overset{\circ}{f}}{2E}}_{\Gamma_{22}^1} v'^2 = 0 \quad \begin{array}{l} \text{2 ways for pract. computation of Christoffel-symb.} \\ 1. \text{ from definition} \end{array}$$

$$\textcircled{II} \quad v'' + \frac{-\overset{*}{h}}{2E} u'^2 + 2 \frac{\overset{\circ}{f}}{2E} u'v' + \frac{\overset{*}{h}}{2E} v'^2 = 0 \quad \begin{array}{l} 2. \text{ via the geod. lines (Hilbert)} \end{array}$$

$$1.) \quad u' \bullet \textcircled{I} + v' \bullet \textcircled{II} =$$

$$\frac{1}{2} \frac{d}{ds} (u'^2 + v'^2) + \frac{1}{2E} (u'^2 + v'^2) \underbrace{(fu' + hv')}_{E'} = 0 \quad 2E$$

$$\frac{d}{ds} \left\{ E(u'^2 + v'^2) \right\} = 0$$

$$\rightarrow \underline{E(u'^2 + v'^2) = \text{const} = 2T} \quad \text{energy integral (intermediate integral)}$$

α.)

$$2.) \quad E \bullet \textcircled{I} \quad \text{with energy integral}$$

$$\rightarrow E \bullet \underbrace{u'' + fu'^2 + hu'v'}_{E'u'} = \frac{1}{2} \overset{\circ}{f} \underbrace{(u'^2 + v'^2)}_{\frac{2T}{E}} \quad \left| \bullet 2Eu' \right.$$

$$\underbrace{2E^2 u'' u' + 2EE' u'^2}_{\frac{d}{ds}(E^2 u'^2)} = \underbrace{f^{\circ} 2Tu'}_{2Tf'}$$

$$\rightarrow E^2 u'^2 = 2Tf + A \quad \text{2nd intermediate integral}$$

$\beta.)$

$$\frac{v'^2}{u'^2} = \frac{2T}{Eu'^2} - 1 = \frac{2TE}{2Tf + A} - 1 = \frac{2Th - A}{2Tf + A} = \frac{h - a}{f + a} \quad a = \frac{A}{2T}$$

$$\left(\frac{dv}{du}\right)^2$$

$$\left| \int \frac{dv}{\sqrt{h(v) - a}} \mp \int \frac{du}{\sqrt{f(u) + a}} = b \right| \quad \text{geod. line}$$

2.) Example: forceless motion on a surface forceless:  $U = 0$

$$\int_{t_0}^{t_1} (\Gamma - U) dt = \text{Extr!} \quad \text{Hamilt. principle} \quad T = \frac{1}{2} m \frac{ds^2}{dt^2} = \frac{m}{2} g_{kl} \dot{u}^k \dot{u}^l$$

$$\frac{1}{2} m \int_{t_0}^{t_1} g_{kl} \dot{u}^k \dot{u}^l dt = \text{Extr!}$$

$$u''^k + \Gamma_{ij}^k u'^i u'^j = 0 \quad \text{geod. line}$$

motion takes place on geodesic lines

§ 12. Main curvature, average and Gaussian curvature.Curvature lines, asymptotic lines

$$\text{Meusnier: } \frac{1}{\rho} \cos \alpha = \frac{\Pi}{I} \quad \dots \quad \alpha = \angle(u, f)$$

$$\rho = \text{curv. radius}$$

$\alpha = 0$  normal cuts

ask question whether the curvature takes extrem values

$$\frac{1}{R} = \frac{\Pi}{I} = \frac{Z}{N} = \text{Extr!}$$

( $\beta$ )

$Z = \text{Extr.}$  together with condition  $N = 1$

$$F^* = Z - \lambda(N - 1) = \underbrace{(b_{kl} - \lambda g_{kl})}_{c_{kl}} du^k du^l + \lambda = \text{Extr}$$

$$F = \text{Extr!}$$

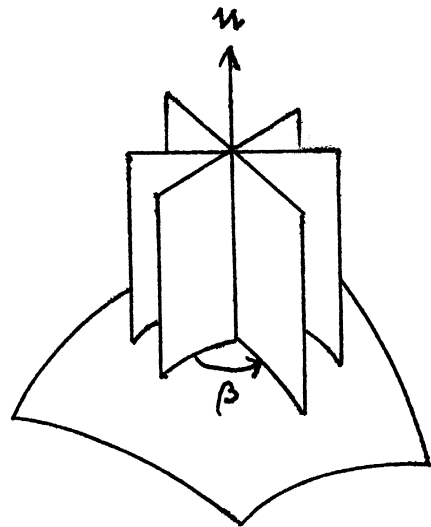

$$\left. \begin{aligned} \frac{1}{2} \frac{\partial F}{\partial du^1} &= c_{11} du^1 + c_{12} du^2 = 0 \\ \frac{1}{2} \frac{\partial F}{\partial du^2} &= c_{21} du^1 + c_{22} du^2 = 0 \end{aligned} \right\} c_{kl} du^l = (b_{kl} - \lambda g_{kl}) du^l = 0$$

$$0 = \begin{vmatrix} b_{11} - \lambda g_{11} & b_{12} - \lambda g_{12} \\ b_{21} - \lambda g_{21} & b_{22} - \lambda g_{22} \end{vmatrix} = b - \lambda ( \underbrace{b_{11} g_{22}}_{gg^{11}} + \underbrace{b_{22} g_{11}}_{gg^{22}} - 2 \underbrace{b_{12} g_{21}}_{-gg^{21}} ) + \lambda^2 g$$

$$= g \cdot \underbrace{b_{kl} g^{kl}}_{b_k^k}$$

$$\lambda^2 - \underbrace{b_k^k}_{2H} \lambda + \underbrace{g}_{K} = 0$$

$\rightarrow \lambda_1, \lambda_2$  for which  $F_{\text{max}}$   
 $F_{\text{min}}$

$F$  hom. quadr.  $\rightarrow F_{\text{extr}} = 0$

$$F_{\text{max}} = Z_{1,2} - \lambda_{1,2} N_{1,2} = 0$$

$$F_{\text{min}}$$



$$\left. \begin{aligned} \lambda_1 &= \frac{Z_1}{N_1} = \frac{1}{R_1} \\ \lambda_2 &= \frac{Z_2}{N_2} = \frac{1}{R_2} \end{aligned} \right\} \text{main curvatures}$$

$$\lambda^2 - \underbrace{2H\lambda}_{\lambda_1 + \lambda_2} + \underbrace{K}_{\lambda_1 \lambda_2} = 0 = (\lambda - \underbrace{\lambda_1}_{1/R_1})(\lambda - \underbrace{\lambda_2}_{1/R_2}) \quad \text{Vieta}$$

$H = \frac{1}{2} \left( \frac{1}{R_1} + \frac{1}{R_2} \right) = \frac{1}{2} b_k^k$	average curvature
$K = \frac{1}{R_1} \cdot \frac{1}{R_2} = \frac{b}{g}$	Gaussian curvature

arithmet.average  $\geq$  geom.average (K is the square of the geom. average)

$$H^2 \geq K \quad \text{for real surfaces}$$

2 invar !

$$H = \frac{1}{2} \frac{EN - 2FM + GL}{EG - F^2} ; \quad K = \frac{LN - M^2}{EG - F^2}$$

-----

points in which

$R_1 = R_2 \neq 0$     navelpoints    sphere consists totally of navelpoints  
paraboloid: one navelpoint

Special case

$$\frac{1}{R_1} = \frac{1}{R_2} = 0 \quad \text{flatpoints}$$

**EX17** H and K

$\alpha.$ )  $z = f(x, y)$

$\beta.$ )  $F(x, y, z) = 0$

$\gamma.$ ) rotation. surfaces.

One establishes first the groundforms  $x = u, y = v$

As will be seen below, 2nd order determinant can be transposed into 3rd order determinant of particularly simple structure.

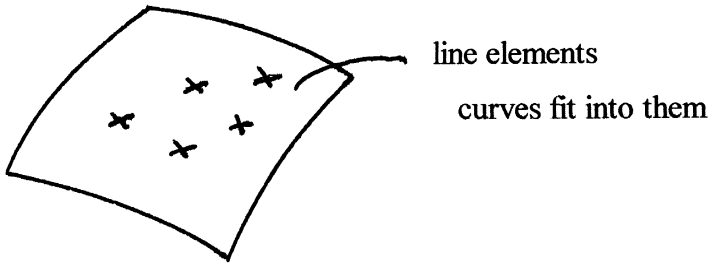

curvature lines

$$\underline{\underline{1}} \cdot \underline{\underline{b_{kl}}} - \underline{\underline{\lambda}} \cdot \underline{\underline{g_{kl}}} du^1 = 0 \quad (k,l=1,2)$$

there exists solution, therefore the determinant must vanish

$$\begin{vmatrix} b_{11} du^1 + b_{12} \frac{du^2}{du^1} & g_{11} du^1 + g_{12} \frac{du^2}{du^1} \\ b_{21} \frac{du^1}{du^2} + b_{22} du^2 & g_{21} \frac{du^1}{du^2} + g_{22} du^2 \end{vmatrix} = 0$$

diff. eq.. of curvature lines

$b_{12}$                        $g_{12}$                        $-du^1 du^2$                       « bordering »

$$\begin{vmatrix} b_{11} & g_{11} & (du^2)^2 \\ b_{12} & g_{12} & -du^1 du^2 \\ b_{22} & g_{22} & (du^1)^2 \end{vmatrix} = 0$$

$$\epsilon^{\alpha\beta} b_{k\alpha} g_{\beta l} du^k du^l = 0$$

$$\epsilon^{\alpha\beta} = \frac{1}{\sqrt{g}} \begin{pmatrix} 0 & 1 \\ -1 & 0 \end{pmatrix}$$

Example  $z = xy$

$\mathcal{C}$

u

v

uv

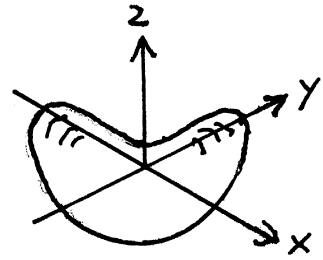

$$(g_{kl}) = \begin{pmatrix} 1+v^2 & uv \\ uv & 1+u^2 \end{pmatrix}; \quad g = 1+u^2+v^2$$

$$(b_{kl}) = -\frac{1}{\sqrt{g}} \begin{pmatrix} 0 & 1 \\ 1 & 0 \end{pmatrix}; \quad b = \frac{1}{\sqrt{g}} \quad K = \frac{-1}{\sqrt{(1+u^2+v^2)^3}} \quad b < 0$$

$$\frac{1}{\sqrt{g}} \begin{vmatrix} 0 & 1+v^2 & dv^2 \\ 1 & uv & dudv \\ 0 & 1+u^2 & du^2 \end{vmatrix} = 0 \quad (1+v^2)du^2 - (1+u^2)dv^2 = 0$$

$$\int \frac{du}{\pm\sqrt{1+u^2}} = \int \frac{dv}{\pm\sqrt{1+v^2}} + C$$

*Int sin u ± Int sin v*

$$v = k\sqrt{1+u^2} \pm u\sqrt{1+k^2}$$

$$y = k\sqrt{1+x^2} \pm x\sqrt{1+k^2}$$

main curvature lines ( $k = 0$ )  
are orthogonal to each other

$$\text{Int } c = k$$

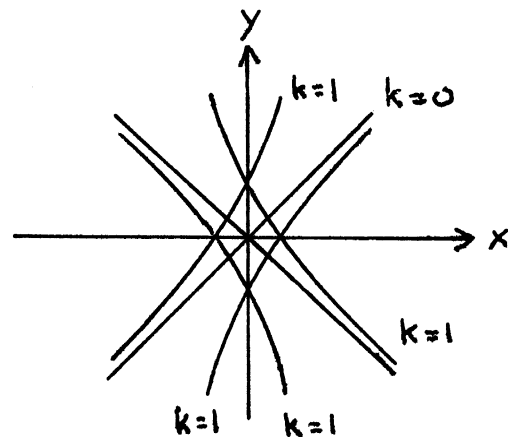

Asymptotic lines

Dupin's indicatrix (shall vanish)

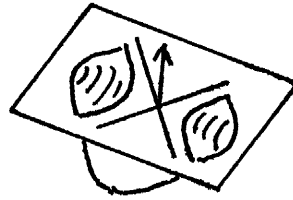

$$K = \frac{b}{g}$$

$$g > 0$$

$$\Pi = b_{kl} du^k du^l = 0 \quad \text{quadr. eq. for } \frac{du^2}{du^1}$$

$$0 = b_{11} + 2b_{12} \frac{du^2}{du^1} + b_{22} \left( \frac{du^2}{du^1} \right)^2 = \frac{1}{b_{22}} \left( b_{22} \frac{du^2}{du^1} + b_{12} - \sqrt{-b} \right) \left( b_{22} \frac{du^2}{du^1} + b_{12} + \sqrt{-b} \right)$$

$$1) \quad b > 0, \quad K > 0 \quad \text{ell. curv. ; } \left( \frac{du^2}{du^1} \right)_{1,2} = \text{compl. conj.}$$

$$2) \quad b = 0, \quad K = 0 \quad \text{par. curv. ; } \left( \frac{du^2}{du^1} \right)_{1,2} = \text{real coincident}$$

$$3) \quad b < 0, \quad K < 0 \quad \text{hyp. curv. ; } \left( \frac{du^2}{du^1} \right)_{1,2} = \text{real different}$$

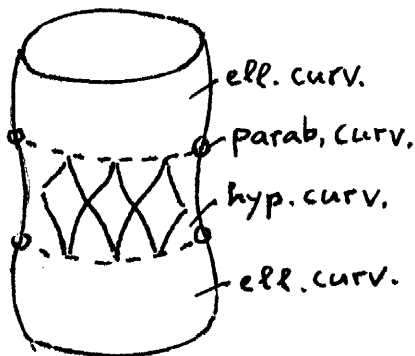
example

asympt. lines. (turning lines)

**EX18** For torus:

can be cast into Liouville form

- 1) geod. lines  $1/R_1 = ?$
- 2) curvature lines  $1/R_2 = ?$
- 3) asymptotic lines  $H = ? \quad K = ?$

Special parameter lines

1) geod. lines bending invariant (geod. field)

$$I = du^2 + g_{22} dv^2 \quad \Pi = b_{11} du^2 + 2b_{12} dudv + b_{22} dv^2$$

2) curvature lines motion invariant (except in the navelpoints)

$$I = g_{11} du^2 + g_{22} dv^2 \quad \Pi = b_{11} du^2 + b_{22} dv^2$$

3) asymptotic lines motion invariant (in hyp. points)

$$I = g_{11} du^2 + 2g_{12} dudv + g_{22} dv^2 \quad \Pi = 2b_{12} dudv$$

§13 Derivative equations

Weingarten's derivative equations

set

$$u_{|k} = B_{kl} \cdot \tau_{|l} \quad \tau_{|n}$$

$$\underbrace{u_{|k} \tau_{|n}}_{-b_{kn}} = B_{kl} \underbrace{\tau_{|l} \tau_{|n}}_{g_{ln}} \quad \Big| \quad g^{nm}$$

$$-b_k^m = B_{km}$$

$$\boxed{u_{|k} = -b_k^m \tau_{|m}}$$

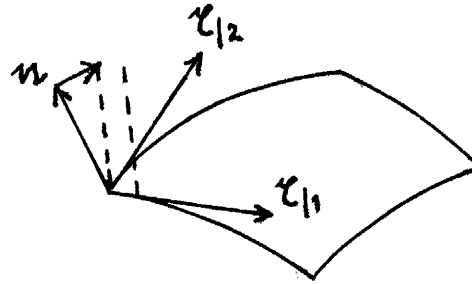

$$\begin{aligned} b_{kl} &= \frac{\partial^2 x^i}{\partial u^k \partial u^l} v_i \\ &= \tau_{|kl} \cdot u \\ &= -u_{|k} \tau_{|l} \quad \text{since} \\ u \cdot \tau_{|l} &= 0 \quad \Big| \quad \frac{\partial}{\partial u^k} \\ u_{|k} \tau_{|l} + u \tau_{|lk} &= 0 \end{aligned}$$

present complete analogy with Frenet's formulae

Formula of Olinde-Rodrigues

curvature lines as parameter lines

$$\left( b_{kl} - \frac{1}{R_v} g_{kl} \right) du^k = 0 \quad | \quad g^{lm}, \quad \left( \frac{d}{ds} = ' \right)$$

$$b_k^m \cdot u'^k = \frac{1}{R_v} \cdot u'^m \quad | \quad \cdot -\zeta_{|m}, \quad -u_{|k} = b_k^m \zeta_{|m}$$

$$u_{|k} \cdot u'^k = -\frac{1}{R_v} \cdot u'^m \cdot \zeta_{|m}$$

$$\boxed{u' = -\frac{1}{R_v} \cdot \zeta'}$$

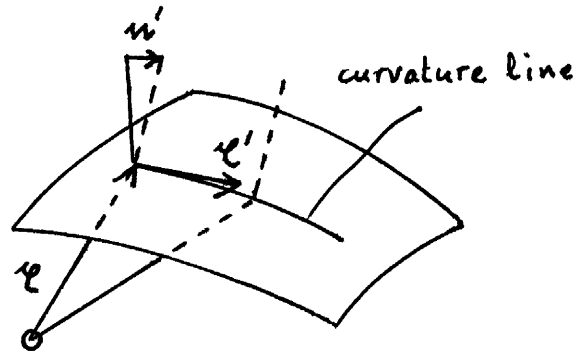
Gauss's derivative equations

(change of the tangent vectors)

other  $B_{kl}$  as previously

$$\zeta_{|kl} = \gamma_{kl}^m \cdot \zeta_{|m} + B_{kl} \cdot u \quad \begin{matrix} 1) \\ u \end{matrix} \quad \begin{matrix} 2) \\ \zeta_{|m} \end{matrix}$$

$$1) \quad \underbrace{\zeta_{|kl} \cdot u}_{b_{kl}} = 0 + B_{kl}$$

$$2) \quad \underbrace{\zeta_{|kl} \cdot \zeta_{|n}}_{\Gamma_{kl,n}} = \underbrace{\gamma_{kl}^m \cdot g_{mn}}_{\gamma_{kl,n}} + 0$$

$$g_{lk|n} = (\zeta_{|k} \zeta_{|n})_{|n} = \zeta_{|kn} \zeta_{|l} + \zeta_{|k} \zeta_{|ln} \quad -\frac{1}{2}$$

$$g_{nl|k} = \zeta_{|lk} \zeta_{|n} + \zeta_{|l} \zeta_{|nk} \quad \frac{1}{2}$$

$$g_{kn|l} = \zeta_{|nl} \zeta_{|k} + \zeta_{|n} \zeta_{|kl} \quad \frac{1}{2}$$

$$\frac{1}{2} \underbrace{(g_{nl|k} + g_{kn|l} - g_{lk|n})}_{\Gamma_{kl,n}} = \zeta_{|kl} \zeta_{|n}$$

$$\boxed{\zeta_{|kl} = \Gamma_{kl}^m \cdot \zeta_{|m} + b_{kl} \cdot u} \rightarrow \zeta_{||kl} = \zeta_{|kl} - \Gamma_{kl}^m \zeta_{|m}$$

$$\boxed{\zeta_{||kl} = b_{kl} \cdot u} \leftarrow \zeta_{|kl} = \Gamma_{kl}^m \zeta_{|m} + \zeta_{||kl}$$

Spherical image of a surface and 3rd groundform

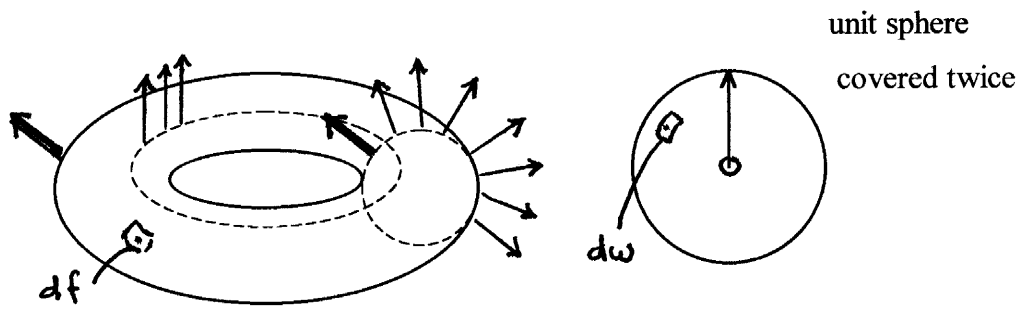

curvature lines as parameterlines

$$df = \langle \tau_{|1} du^1, \tau_{|2} du^2, n \rangle$$

$$d\omega = \langle \underbrace{n_{|1}}_{-\frac{1}{R_1} \tau_{|1}} du^1, \underbrace{n_{|2}}_{-\frac{1}{R_2} \tau_{|2}} du^2, n \rangle$$

$$= \frac{1}{R_1 \cdot R_2} \cdot df$$

$$= \frac{1}{K} \cdot df$$

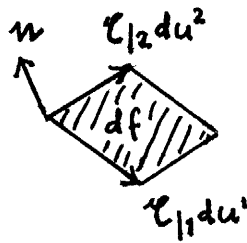

counterexample

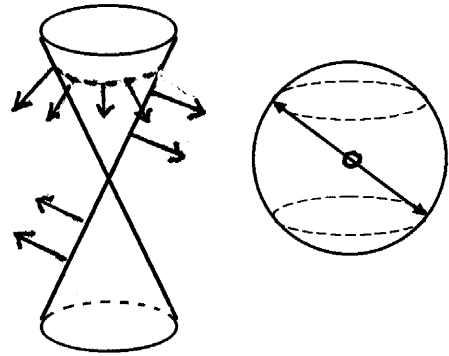

$$\boxed{K = \frac{d\omega}{df}} \quad \text{compare with} \quad \kappa = \frac{d\alpha}{ds}$$

general

$$III = d\sigma^2 = \underbrace{n_{|i} n_{|k}}_{c_{ik}} du^i du^k$$

$$n = \frac{[\tau_{|1} \tau_{|2}]}{\sqrt{g}}$$

$d\sigma$  arc element in the spherical image

One can prove (see below)

$$K \cdot I - 2H II + III = 0 \quad \text{i.e.} \quad c_{ik} = -Kg_{ik} + 2H \cdot b_{ik}$$

Proof of the equation  $K \bullet I - 2H \bullet II + III = 0$

$$III = \mathbf{u}_{|i} \mathbf{u}_{|k} du^i du^k$$

Weingarten:  $\mathbf{u}_{|i} = -b_i^m \boldsymbol{\zeta}_{|m}$      $\mathbf{u}_{|k} = -b_k^n \boldsymbol{\zeta}_{|n}$

$$III = b_i^m b_k^n \underbrace{\boldsymbol{\zeta}_{|m} \boldsymbol{\zeta}_{|n}}_{g_{mn}} du^i du^k = g_{mn} \underbrace{b_i^m}_{b_{in}} \underbrace{b_k^n}_{b_{kn} g^m} du^i du^k$$

$$\frac{b}{g} g_{ik} du^i du^k - \underbrace{b_q^q}_{b_{qs} g^{sq}} b_{ik} du^i du^k + b_{in} b_{kn} g^m du^i du^k = 0$$

$$\frac{b}{g} g_{ik} du^i du^k - b_{qs} b_{ik} g^{sq} du^i du^k + b_{in} b_{kn} g^m du^i du^k = 0$$

With  $g^{11} = \frac{g_{22}}{g}$      $g^{12} = -\frac{g_{12}}{g}$      $g^{22} = \frac{g_{11}}{g}$     we thus obtain

$$\frac{b}{g} g^{11} (du^2)^2 - b_{11} b_{ik} g^{1i} du^i du^k + b_{11} b_{k1} g^{1k} du^i du^k = 0$$

yielding explicitly

$$\begin{aligned} & b(du^2)^2 - \cancel{b_{11}^2 (du^1)^2} - \cancel{2b_{11} b_{12} du^1 du^2} - b_{11} b_{22} (du^2)^2 + \cancel{b_{11}^2 (du^1)^2} + b_{21}^2 (du^2)^2 + \cancel{2b_{11} b_{21} du^1 du^2} \\ & = b(du^2)^2 - \underbrace{(b_{11} b_{22} - b_{21}^2)}_b (du^2)^2 = 0 \end{aligned}$$



§ 14 Parallel transport according to Levi-Civita; integrability conditions

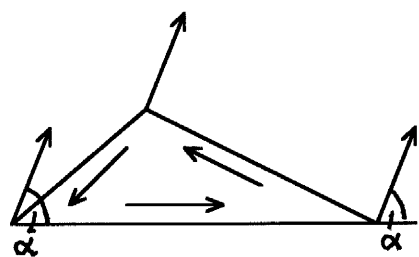

The parallel transport of a vector  $w$  along a triangle in the Euclidean plane takes it back to itself and can be characterized by the constant value of the angle  $\alpha$ .

Along an arbitrary line the characterization by an angle is not sufficient any more. Even more difficult becomes

the characterization on an arbitrary space surface e.g. a sphere. We move  $w$  along geodesic lines (corresponding to straight lines) on a main triangle.  $w$  is shifted after the circuit into a

different position: the circuit is no longer « integrable ».



(Circuits are integrable only in Euclidean spaces, so that it is sufficient and necessary that  $K = 0$ ; the difference in positions of  $w$  before and after the circuit is a measure for  $K$ )

Set  $' = \frac{d}{ds}$ . For an inhabitant of the sphere with only two-dimensional sense (the two surface

directions), changes of  $w$  in normal direction can be admissible during parallel transport (since he cannot perceive them). Thus  $w' \perp w$  e.g.  $w$  in the tangent direction of the equator.

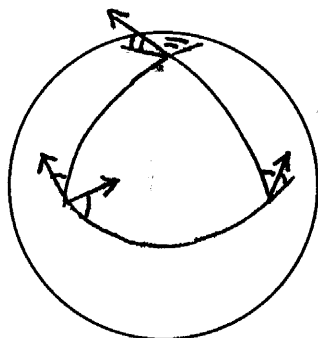

We set up  $w$  as a linear combination of the

surface tangent vectors:  $w = w^j \xi_j$

$$w' = w'^j \xi_j + w^j \underbrace{\xi_{|jk}}_{\Gamma_{jk}^n \xi_n + b_{jk} n} u'^k \quad | \cdot \xi_m$$

(Gauss)

$$w' \xi_m = 0 = w'^j g_{mj} + w^j \Gamma_{jk}^n g_{mn} u'^k + 0 \quad | \quad g^{mp}$$

$$w'^p + w^j \Gamma_{jk}^p u'^k = \frac{dw^p}{ds} = 0$$

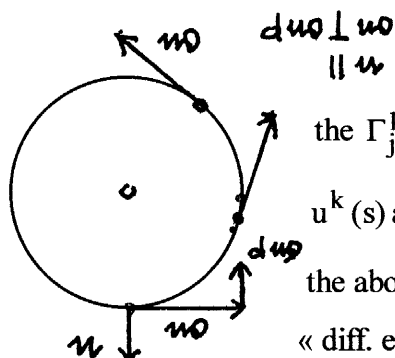

the  $\Gamma_{jk}^p$  are fixed for a given surface.

$u^k(s)$  are given as a curve on the surface, hence also the  $u'^k(s)$ ;

the above equation is thus a differential eq. for the  $w^j(s)$ :

« diff. eq. of parallel transport according to Levi-Civita »

The solution of the equation needs the integration of the first derivative (which, historically, has been introduced at this point).

e.g. unit sphere in the  $R_3$

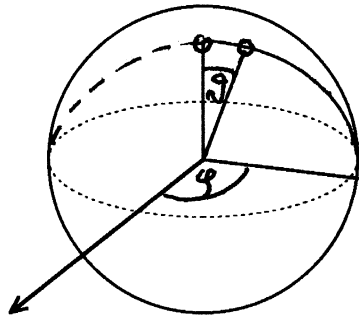

$$\mathcal{U} = \begin{pmatrix} \cos\varphi \sin\vartheta \\ \sin\varphi \sin\vartheta \\ \cos\vartheta \end{pmatrix}$$

$$I = ds^2 = \underbrace{\sin^2\vartheta d\varphi^2}_{g_{11}} + \underbrace{1}_{g_{22}} d\vartheta^2$$

the Christoffel symbols are most simply calculated from the postulate

$$\int (\sin^2\vartheta \dot{\varphi}^2 + \dot{\vartheta}^2) dt = \text{Min as coefficients of Euler's equations:}$$

$$\ddot{\varphi} + \underbrace{2 \cot\vartheta g\vartheta}_{\Gamma_{12}^1} \dot{\varphi} = 0 \quad \ddot{\vartheta} + \underbrace{(-\sin\vartheta \cos\vartheta)}_{\Gamma_{11}^2} \dot{\varphi}^2 = 0$$

i.e. in matrix form:

$$\Gamma_{ik}^1 = \begin{pmatrix} 0 & \cot\vartheta \\ \cot\vartheta & 0 \end{pmatrix} \quad \Gamma_{ik}^2 = \begin{pmatrix} -\sin\vartheta \cos\vartheta & 0 \\ 0 & 0 \end{pmatrix}$$

Let the components of the vector  $w$  be  $w^1 = \Phi$   
 $w^2 = \Theta$

then the diff. equation of the parallel transport according to Levi-Civita is:

$$\left. \begin{aligned} \Phi' + (\Theta \dot{\varphi} + \Phi \dot{\vartheta}) \cot\vartheta &= 0 \\ \Theta' + (-\Phi \dot{\varphi} \sin\vartheta \cos\vartheta) &= 0 \end{aligned} \right\} \begin{aligned} \Phi &= a \\ \Theta &= b \end{aligned}$$

if the trajectory is the equator then  $\vartheta = \frac{\pi}{2}$ . We thus have

$\mathcal{U}_{ 1}$	$(\vartheta = \frac{\pi}{2})$	$\mathcal{U}_{ 2}$	$(\vartheta = \frac{\pi}{2})$	$w = w^j \mathcal{U}_{ j}$
$\sin\varphi \sin\vartheta$	$-\sin\varphi$	$\cos\varphi \cos\vartheta$	$0$	$-a \sin\varphi + 0 \cdot b$
$\cos\varphi \sin\vartheta$	$\cos\varphi$	$\sin\varphi \cos\vartheta$	$0$	$a \cos\varphi + 0 \cdot b$
$0$	$0$	$-\sin\vartheta$	$-1$	$0 \cdot a - b$

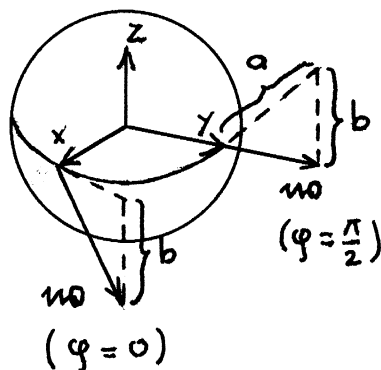

$$w = \begin{pmatrix} -a \sin\varphi \\ a \cos\varphi \\ -b \end{pmatrix}$$

Parallel transport of the vector  $w^i$  over a closed contour on the unit sphere.

The contour is the triangle with corner points M, N, O. M and N are located on the equator, O is the north pole. The trajectories are: from the starting point M to the point N the equator, from N to O and from O back to M the corresponding meridians.

For points situated on the equator we use the formula previously derived i.e.

$$w^i = \begin{pmatrix} -a \sin \varphi \\ a \cos \varphi \\ -b \end{pmatrix} \quad \text{and hence M: } \varphi = 0 \quad w^i = \begin{pmatrix} 0 \\ a \\ -b \end{pmatrix} \quad \text{N: } \varphi = \frac{\pi}{2} \quad w^i = \begin{pmatrix} 0 \\ a \\ -b \end{pmatrix}$$

Notations are as previously i.e.  $w^i = w^j \zeta_{|j}$   $w^1 = \Phi$   $w^2 = \Theta$

$$1) \text{ Way upwards from N to O: } \varphi = \frac{\pi}{2} \quad ds = -d\vartheta \quad \vartheta' = \frac{d\vartheta}{ds} = -1 \quad \Phi' = \frac{d\Phi}{ds} = -\frac{d\Phi}{d\vartheta}$$

Differential equations for parallel transport

$$-\frac{d\Phi}{d\vartheta} - \Phi \cot \vartheta = 0 \quad \text{solution: } \Phi = \frac{C}{\sin \vartheta} = w^1$$

$$\Theta' = 0 \quad \text{solution } \Theta = A = w^2$$

Vector moving on the meridian

$$w^i = \frac{C}{\sin \vartheta} \begin{pmatrix} -\sin \vartheta \\ 0 \\ 0 \end{pmatrix} + A \begin{pmatrix} 0 \\ \cos \vartheta \\ -\sin \vartheta \end{pmatrix} = C \begin{pmatrix} -1 \\ 0 \\ 0 \end{pmatrix} + A \begin{pmatrix} 0 \\ \cos \vartheta \\ -\sin \vartheta \end{pmatrix}$$

Constants C and A are determined from initial conditions at point N where  $\vartheta = \frac{\pi}{2}$

$$\begin{pmatrix} -a \\ 0 \\ -b \end{pmatrix} = C \begin{pmatrix} -1 \\ 0 \\ 0 \end{pmatrix} + A \begin{pmatrix} 0 \\ 0 \\ -1 \end{pmatrix} \rightarrow C = a \quad A = b$$

Hence the components on this trajectory are

$$w^i = \begin{pmatrix} -a \\ b \cos \vartheta \\ -b \sin \vartheta \end{pmatrix} \quad \text{with for } \vartheta = 0 \text{ at the endpoint O i.e. the pole: } w^i = \begin{pmatrix} -a \\ b \\ 0 \end{pmatrix}$$

$$2) \text{ Way downwards from O back to M: } \varphi = 0 \quad ds = d\vartheta \quad \vartheta' = 1 \quad \Phi' = \frac{d\Phi}{d\vartheta}$$

$$\frac{d\Phi}{d\vartheta} + \Phi \cot \vartheta = 0 \quad \text{solution: } \Phi = \frac{C'}{\sin \vartheta} = w^1$$

$$\Theta' = 0 \quad \text{solution } \Theta = A' = w^2$$

$$\mathbf{w} = \frac{C'}{\sin \vartheta} \begin{pmatrix} 0 \\ \sin \vartheta \\ 0 \end{pmatrix} + A' \begin{pmatrix} \cos \vartheta \\ 0 \\ -\sin \vartheta \end{pmatrix} = C' \begin{pmatrix} 0 \\ 1 \\ 0 \end{pmatrix} + A' \begin{pmatrix} \cos \vartheta \\ 0 \\ -\sin \vartheta \end{pmatrix}$$

Initial condition at point O  $\vartheta = 0$

$$\begin{pmatrix} -a \\ b \\ 0 \end{pmatrix} = C' \begin{pmatrix} 0 \\ 1 \\ 0 \end{pmatrix} + A' \begin{pmatrix} 1 \\ 0 \\ 0 \end{pmatrix} \rightarrow \begin{matrix} A' = -a \\ C' = b \end{matrix} \quad \text{yielding}$$

$$\mathbf{w} = \begin{pmatrix} -a \cos \vartheta \\ b \\ a \sin \vartheta \end{pmatrix}$$

At the final destination M we then have with  $\vartheta = \frac{\pi}{2}$

$$\mathbf{w} = \begin{pmatrix} 0 \\ b \\ a \end{pmatrix}$$

Thus the vector has changed after the transport

$$\text{from } \mathbf{w} = \begin{pmatrix} 0 \\ a \\ -b \end{pmatrix} \text{ initial value, to } \mathbf{w} = \begin{pmatrix} 0 \\ b \\ a \end{pmatrix} \text{ final value.}$$

Note that at any moment during the transport the value  $\mathbf{w}^2 = a^2 + b^2$  is conserved.

Equations of Mainardi-Codazzi and Gauss

Riemann's curvature tensor and theorem egregium of Gauss

We use

$$\left. \begin{array}{l} \text{Weingarten} \quad \mathcal{U}_{|k} = -b_k^m \mathcal{Z}_{|m} \quad 2 \text{ equations} \\ \text{Gauss} \quad \mathcal{Z}_{|kl} = \Gamma_{kl}^m \mathcal{Z}_{|m} + b_{kl} \mathcal{U} \quad 4 \text{ equations} \end{array} \right\} \text{for surfaces in space}$$

let be given arbitrary  $g_{ik}$  and  $b_{ik}$ , does a real surface exist for these?

the  $\Gamma_{kl}^m$  und  $b_k^m$  can be calculated first; then the above equations represent 6 linear partial differential equations for

$$\mathcal{Z}_{|11} \dots \mathcal{Z}_{|22} \quad \text{and} \quad \mathcal{U}_{|1} \quad \mathcal{U}_{|2} \quad \text{or}$$

$$\mathcal{Z}(u^i) \quad \text{and} \quad \mathcal{U}(u^i) \quad \text{such that with } \mathcal{Z}(u^i) \text{ the surface in question is determined.}$$

Here we indicate only the necessary conditions for the solution:

on a real surface is necessary:

$$1.) \quad \mathcal{Z}_{|kl} = \mathcal{Z}_{|lk} \quad 2.) \quad \mathcal{Z}_{|kln} = \mathcal{Z}_{|knl} \quad 3.) \quad \mathcal{U}_{|kl} = \mathcal{U}_{|lk}$$

1.) follows already from the symmetry of the given  $g_{ik}$ ,  $b_{ik}$

$$\begin{aligned} 2.) \quad & \mathcal{Z}_{|kln} = \left( \Gamma_{kl}^m \right)_{|n} \mathcal{Z}_{|m} + \Gamma_{kl}^m \mathcal{Z}_{|mn} + (b_{kl})_{|n} \mathcal{U} + b_{kl} \underbrace{\mathcal{U}_{|n}} \\ & \Gamma_{mn}^i \mathcal{Z}_{|i} + b_{mn} \mathcal{U} \quad - b_n^m \mathcal{Z}_{|m} \\ & = \mathcal{U} \left( b_{kl|n} + \Gamma_{kl}^m b_{mn} \right) + \mathcal{Z}_{|m} \left( -b_{kl} b_n^m + \Gamma_{kl|n}^m + \Gamma_{kl}^i \Gamma_{in}^m \right) \end{aligned}$$

comparison of coefficients

$$a.) \quad b_{kl|n} = b_{kn|l} \rightarrow \text{equation of Mainardi-Codazzi}$$

(1857) (1868)

2 equations (only for  $n \neq l$  significant statement)

$$\mathcal{Z}_{|knl} = \left( b_{kn|l} + \Gamma_{kn}^m b_{ml} \right) + \mathcal{Z}_{|m} \left( -b_{kn} b_l^m + \Gamma_{kn|l}^m + \Gamma_{kn}^i \Gamma_{il}^m \right)$$

$$b_{kl|n} + \Gamma_{kl}^m b_{mn} = b_{kn|l} + \Gamma_{kn}^m b_{ml}$$

$$\underbrace{b_{kl|n} - \Gamma_{kn}^m b_{ml} - \Gamma_{ln}^m b_{km}}_{b_{kl|n}} = \underbrace{b_{kn|l} - \Gamma_{kl}^m b_{mn} - \Gamma_{nl}^m b_{km}}_{b_{kn|l}}$$

b.)

$$\underbrace{b_{kl}b_n^m - b_{kn}b_l^m}_{-R_{\bullet kln}^m} = \Gamma_{kl|n}^m + \Gamma_{kl}^i \bullet \Gamma_{in}^m - \Gamma_{kn|l}^m - \Gamma_{kn}^i \bullet \Gamma_{il}^m$$

$$-R_{\bullet kln}^m = -g^{im} R_{ikln} \quad \text{4th rank tensor}$$

$$\boxed{R_{ikln} = b_{il}b_{kn} - b_{in}b_{kl}} \quad \text{Riemann's curvature tensor !}$$

$$\boxed{-R_{\bullet kln}^m = \Gamma_{kl|n}^m + \Gamma_{kl}^i \Gamma_{in}^m - \Gamma_{kn|l}^m - \Gamma_{kn}^i \Gamma_{il}^m} \quad \text{Gauss}$$

$$R_{1212} = b_{11}b_{22} - b_{12}b_{21} = g \bullet K$$

b

$$\boxed{K = \frac{R_{1212}}{g}} \quad \text{theorema egregium}$$

The Gaussian curvature is invariant against bendings

The following relations hold

$$R_{iklm} + R_{likm} + R_{klim} = 0$$

$$R_{iklm} = R_{lmik} = -R_{kilm} = -R_{ikml} = R_{kiml}$$

e.g.

$$R_{11lm} = -R_{11lm} = 0$$

$T_2$  in the  $R_3$  :  $2^4 = 16$  comp. all vanishing except

$$R_{1212} = R_{2121} = -R_{1221} = -R_{2112} = b = gK$$

$T_3$  in the  $R_4$  :  $3^4 = 81$  comp. 45 vanish; among the remaining 36 only 6 essentially different.

**EX19** How many components possesses Riemann's curvature tensor for a partial space  $T_m$  in the  $R_n$  ( $m \leq n$ ) ?

$$R_{\bullet klm}^m = R_{kl} \quad \text{contracted or reduced Riemannian curvature tensor}$$

Remarks on non Euklidian geometries and on special relativity theory

Euklidian geometry

1.) Axiomatically defined

2.)  $ds^2 = dx^i dx^i$  can be generated (by introduction of appropriate coordinates)

3.)  $ds^2 = g_{ik} du^i du^k$

$T_2$  in the  $R_3$   $K = 0$  (parabolic curvature)

(parallel transport integrable)  $R_{iklm} \equiv 0$

question of embedding not clarified as yet. One suspects:

Riemannian manifold to be embeddable in  $N = \frac{n(n+1)}{2}$

Non Euklidian geometries

1.) every non Euklidian geometry

2.) defined by

$ds^2 = g_{ik} du^i du^k$  f.  $T_2$  in the  $R_3$   $K \equiv \text{const} \neq 0$   $\begin{cases} > 0 & \text{ell. case (sphere)} \\ < 0 & \text{hyp. case (pseudosphere)} \end{cases}$

$$z = \sqrt{1-r^2} - \frac{1}{2} \ln \frac{1 + \sqrt{1-r^2}}{1 - \sqrt{1-r^2}}$$

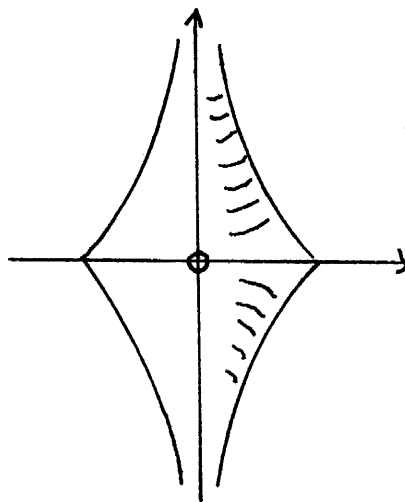

Tractrix « dogs curve »

3.) Only hyp. geom.

F. 2.) contains the parallel axiom and the ordering axiom

3.) only parallel axiom

Tractrix - derivation of Gauss curvature  $K = -1$

$$u^1 = r \quad u^2 = \varphi$$

$\mathcal{U}$	$\mathcal{U}_{11}$	$\mathcal{U}_{12}$	$\mathcal{U}_{111}$	$\mathcal{U}_{112}$	$\mathcal{U}_{122}$
$r \cos \varphi$	$\cos \varphi$	$-r \sin \varphi$	0	$-\sin \varphi$	$-r \cos \varphi$
$r \sin \varphi$	$\sin \varphi$	$r \cos \varphi$	0	$\cos \varphi$	$-r \sin \varphi$
$f(r)$	$f'$	0	$f''$	0	0

$$g_{11} = 1 + f'^2 \quad g_{22} = r^2 \quad g_{12} = 0 \quad g = \begin{vmatrix} 1 + f'^2 & 0 \\ 0 & r^2 \end{vmatrix} = r^2(1 + f'^2)$$

Determinants

$$|11| = \begin{vmatrix} \cos \varphi & -r \sin \varphi & 0 \\ \sin \varphi & r \cos \varphi & 0 \\ f' & 0 & f'' \end{vmatrix} = f'' r$$

$$|12| = \begin{vmatrix} \cos \varphi & -r \sin \varphi & -\sin \varphi \\ \sin \varphi & r \cos \varphi & \cos \varphi \\ f' & 0 & 0 \end{vmatrix} = 0$$

$$|22| = \begin{vmatrix} \cos \varphi & -r \sin \varphi & -r \cos \varphi \\ \sin \varphi & r \cos \varphi & -r \sin \varphi \\ f' & 0 & 0 \end{vmatrix} = f' r^2$$

$$g = r^2(1 + f'^2)$$

$$(b_{ik}) = \frac{1}{\sqrt{g}} \begin{pmatrix} f'' r & 0 \\ 0 & f' r^2 \end{pmatrix}$$

$$b = \frac{r^2 f' f''}{\sqrt{1 + f'^2}} \quad K = \frac{b}{g} = \frac{f' f''}{(1 + f'^2)^{3/2}}$$

According to the last expression we therefore have

$$K = -\frac{d}{dr} \frac{1}{\sqrt{1 + f'^2}}$$



Explicitly we have

$$f = \sqrt{1-r^2} - \frac{1}{2} \ln(1 + \sqrt{1-r^2}) + \frac{1}{2} \ln(1 - \sqrt{1-r^2})$$

$$f' = \frac{-r}{\sqrt{1-r^2}} - \frac{1}{2} \frac{\frac{-r}{\sqrt{1-r^2}}}{1 + \sqrt{1-r^2}} + \frac{1}{2} \frac{\frac{r}{\sqrt{1-r^2}}}{1 - \sqrt{1-r^2}} = \frac{-r}{\sqrt{1-r^2}} + \frac{1}{2} \frac{r}{\sqrt{1-r^2}} \frac{2}{r^2} = \frac{1}{\sqrt{1-r^2}} \left( -r + \frac{1}{r} \right) = \frac{\sqrt{1-r^2}}{r}$$

yielding  $1 + f'^2 = \frac{1}{r^2}$  and  $\frac{1}{\sqrt{1+f'^2}} = r$

Thus we find  $K = -\frac{d}{dr} r$  and hence

$$K = -1 \quad \text{q.e.d.}$$

$$R_{iklm} = b_{il}b_{km} - b_{im}b_{kl}$$

$$= b_{il} \underbrace{\quad}_{\text{u u}} b_{km} - b_{im} \underbrace{\quad}_{\text{u u}} b_{kl}$$

$$\underbrace{\quad}_{\text{u}} \parallel_{kl} = b_{kl} \quad \text{Gauss}$$

$R_{iklm} = \underbrace{\quad}_{\text{u}} \parallel_{il} \cdot \underbrace{\quad}_{\text{u}} \parallel_{km} - \underbrace{\quad}_{\text{u}} \parallel_{im} \cdot \underbrace{\quad}_{\text{u}} \parallel_{kl}$
$R_{\bullet klm}^m = \Gamma_{kl n}^m + \Gamma_{kl}^i \Gamma_{in}^m - \Gamma_{kn l}^m - \Gamma_{kn}^i \Gamma_{il}^m$
$K = \frac{R_{1212}}{g}$

n	signific. different comp.
1	0
2	1
3	6
4	20

$$R_{kl} = \underbrace{g^{im} R_{iklm}}_{\text{disappear if Gaussian curvature disappears}}$$

$$\left\{ \begin{matrix} G_{kl} \\ B_{kl} \end{matrix} \right\} \quad \text{(Einstein)}$$

$T_2$  in the  $R_3$

**EX20**  $\boxed{K = -\frac{R_{kl}}{g_{kl}}}$   
(no summ)

$g_{kl} \neq 0$

$K = 0 \leftrightarrow R_{kl} \equiv 0$

$R = g^{kl} R_{kl}$

**EX21**  $\boxed{K = -\frac{R}{2}}$

$T_2$  in the  $R_3$

Bonnet's theorem: the  $g_{kl}(u^i)$  and  $b_{kl}(u^i)$  determine, except for position and orientation, a space surface uniquely, provided that certain continuity- and derivability conditions as well as the integrability condition are valid.

Special relativity theory

Ether, hypothesis:

- 1.) Total rest
- 2.) Total dragging
- 3.) Partial dragging (only large bodies drag it)
- 4.) Translat. - dragging
- 5.) Part.
- 6.) Rotat.
- 7.) Part. rotat.
- 8.)  $c$  depending on the velocity of the light source Walter Ritz

Michelson experiment 1881

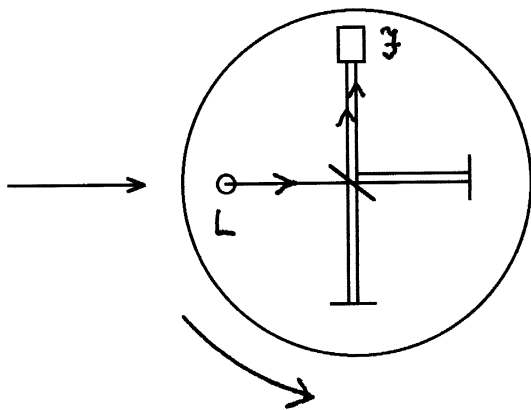

11 meter diameter

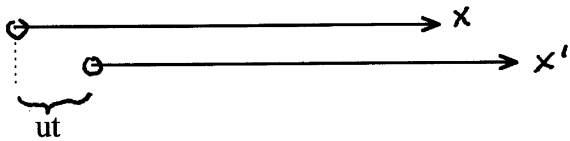

$$x^2 + y^2 + z^2 - c^2 t^2 = x'^2 + y'^2 + z'^2 - c^2 t'^2 = 0$$

Galilei:

$$x' = x - ut, \quad y' = y, \quad z' = z, \quad t' = t$$

Lorentz:

$$x' = \gamma(x - ut) \quad , \quad t' = \gamma(t - \chi x)$$

$$x^2 + y^2 + z^2 - c^2 t^2 = \gamma^2(x^2 - 2uxt + u^2 t^2) + y^2 + z^2 - c^2 \gamma^2(t^2 - 2\chi tx + \chi^2 x^2)$$

$$x^2: \quad 1 = \gamma^2 - c^2 \gamma^2 \chi^2$$

$$t^2: \quad -c^2 = \gamma^2 u^2 - c^2 \gamma^2 \quad \quad \quad xt: \quad 0 = -2u\gamma^2 + 2\chi\gamma^2 c^2$$

$$\chi = \frac{u}{c^2} \quad \quad \quad \gamma^2 = \frac{-c^2}{u^2 - c^2}$$

$$\gamma = \frac{1}{\sqrt{1 - \frac{u^2}{c^2}}}$$

$$x' = \frac{x - ut}{\sqrt{1 - \frac{u^2}{c^2}}} \quad y' = y \quad z' = z \quad t' = \frac{t - \frac{u}{c^2} x}{\sqrt{1 - \frac{u^2}{c^2}}}$$

if  $c \rightarrow \infty$ , the Lorentz-transformation would merge into the Galilei-transformation

$$(\pm) ds^2 = dx^2 + dy^2 + dz^2 - c^2 dt^2 = dx'^2 + dy'^2 + dz'^2 - c^2 dt'^2 \quad \text{Lorentz invariant}$$

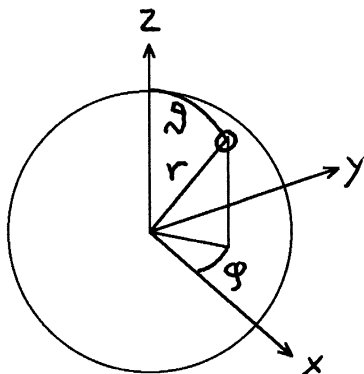

$$x, y, z, -ict \quad \quad \quad \begin{aligned} x &= r \cos \varphi \sin \vartheta \\ y &= r \sin \varphi \sin \vartheta \\ z &= r \cos \vartheta \end{aligned}$$

« pseudo-Euklidian metric »

$$ds^2 = dr^2 + r^2 d\vartheta^2 + r^2 \sin^2 \vartheta d\varphi^2 - c^2 dt^2$$

§ 16. General relativity theory1.) Laplace - Poisson

$$\Delta\varphi = 4\pi\gamma\rho$$

$$\rho = 0$$

$$\Delta\varphi = 0$$

special case :

$$\varphi_{rr} + \frac{2}{r}\varphi_r$$

spherical symmetry

force  $\vec{K}$

$$\vec{K} = -\gamma \frac{mM}{|\vec{r}|^3} \vec{r}$$

$$= m \left( -\frac{\gamma M}{|\vec{r}|^3} \right) \vec{r}$$

$$= -m \text{grad} \left( \underbrace{-\frac{\gamma M}{r} + c_1}_{\varphi} \right) = 0$$

Seeliger:

$$\varphi = -\frac{\gamma M}{r} e^{-\mu r}$$

2.) Einstein: cosmological constant (highly controversial)

$$R_{ik} - \frac{1}{2} R g_{ik} - \lambda g_{ik} = -\kappa T_{ik}$$

1) line element

2) mass curvature

3) geodesic lines

matter-free space (only one mass at the origin)

special case  $T_{ik} \equiv 0 \quad \lambda = 0$

$$R_{ik} - \frac{1}{2} R g_{ik} = 0 \quad g^{ik} \rightarrow R - \frac{1}{2} R \cdot \underbrace{\delta_j^i}_4 = 0$$

$$\boxed{R_{ik} = 0} \quad \rightarrow R = 0$$

Another important special case is the limit of Newtonian mechanics. One can show that in this case Einstein's equation reduces to

$$R_{00} - g_{00}R = \frac{1}{c^2} \Delta\varphi \quad R = g^{km} R_{km}$$

Euklidian:

$$ds^2 = c^2 dt^2 - dr^2 - r^2 d\vartheta^2 - r^2 \sin^2 \vartheta d\varphi^2$$

$$t = u^0$$

$$r = u^1$$

$$\vartheta = u^2$$

$$\varphi = u^3$$

set up according to Schwarzschild:

$$ds^2 = \underbrace{g_0(r)}_{g_{00}} dt^2 - \underbrace{g_1(r)}_{g_{11}} dr^2 - \underbrace{r^2}_{g_{22}} d\vartheta^2 - \underbrace{r^2 \sin^2 \vartheta}_{g_{33}} d\varphi^2$$

$$g^{ik} = \begin{pmatrix} 1/g_0 & & & \\ & -1/g_1 & & \\ & & -1/r^2 & \\ & & & -\frac{1}{r^2 \sin^2 \vartheta} \end{pmatrix}$$

$$\Gamma_{ik,l} = \frac{1}{2} \{ g_{i|k} + g_{k|i} - g_{ik|l} \}$$

$$\Gamma_{ik}^m = \Gamma_{ik,l} \cdot g^{lm} = \Gamma_{ik,m} g^{mm}$$

$$\Gamma_{ik,0} = \frac{1}{2} \{ g_{i0|k} + g_{k0|i} - g_{ik|0} \} = \begin{pmatrix} 0 & \frac{g'_{i0}}{2} & 0 & 0 \\ \frac{g'_{i0}}{2} & & & \\ 0 & & & \\ 0 & & & \end{pmatrix}$$

$$\Gamma_{ik}^0 = \Gamma_{ik,0} g^{00} = \frac{1}{g_0} \Gamma_{ik,0}$$

$$\Gamma_{ik}^0 = \begin{pmatrix} 0 & \frac{g'_0}{2g_0} & 0 & 0 \\ \frac{g'_0}{2g_0} & & & \\ 0 & & & \\ 0 & & & \end{pmatrix}, \quad \Gamma_{ik}^1 = \begin{pmatrix} \frac{g'_0}{2g_1} & & & \\ & \frac{g'_1}{2g_1} & & \\ & & -\frac{r}{g_1} & \\ & & & -\frac{r \sin^2 \vartheta}{g_1} \end{pmatrix}$$

$$\Gamma_{ik}^2 = \begin{pmatrix} 0 & 0 & 0 & 0 \\ 0 & 0 & 1/r & 0 \\ 0 & 1/r & 0 & 0 \\ 0 & 0 & 0 & -\sin \vartheta \cos \vartheta \end{pmatrix}, \quad \Gamma_{ik}^3 = \begin{pmatrix} 0 & 0 & 0 & 0 \\ 0 & & & 1/r \\ 0 & & & 0 \\ 0 & 1/r & \cot g \vartheta & 0 \end{pmatrix}$$

$$R_{\bullet ijk}^1 = \Gamma_{ik|j}^1 - \Gamma_{ij|k}^1 + \Gamma_{ik}^m \Gamma_{mj}^1 - \Gamma_{ij}^m \Gamma_{mk}^1$$

$$l = k$$

$$R_{ij} = R_{\bullet ijk}^k$$

$$\begin{aligned} R_{00} &= R_{00k}^k = \underbrace{\Gamma_{0k|0}^k}_{\delta} - \Gamma_{00|k}^k + \Gamma_{0k}^m \Gamma_{m0}^k - \Gamma_{00}^m \Gamma_{mk}^k \\ &= -\Gamma_{00|1}^1 + 2\Gamma_{01}^0 \Gamma_{00}^1 - \Gamma_{00}^1 \Gamma_{1k}^k \\ &= -\Gamma_{00|1}^1 + \Gamma_{00}^1 (\Gamma_{10}^0 - \Gamma_{11}^1 - \Gamma_{12}^2 - \Gamma_{13}^3) \\ &= -\left(\frac{g'_0}{2g_1}\right)' + \frac{g'_0}{2g_1} \left(\frac{1}{2} \frac{g'_0}{g_0} - \frac{g'_1}{2g_1} - \frac{1}{r} - \frac{1}{r}\right) \\ &= -\frac{1}{g_1} \left(\frac{g''_0}{2} - \frac{g'_0 g'_1}{4g_1} - \frac{g_0'^2}{4g_0} + \frac{g'_0}{r}\right) = 0 \quad \text{f. } r \neq 0 \end{aligned}$$

$$R_{11} = -\frac{1}{g_0} \left(\frac{g''_0}{2} - \frac{g'_0 g'_1}{4g_1} - \frac{g_0'^2}{4g_0} - \frac{g_0 g'_1}{r g_1}\right) = 0$$

$$R_{22} = \frac{r g'_0}{2g_0 g_1} + \frac{r g'_1}{2g_1^2} = 0$$

$$R_{33} = R_{22} \sin^2 \vartheta = 0$$

$$R_{ij} = 0 \quad \text{f. } i \neq j \quad \text{and further}$$

$$R_{00} - \frac{1}{2} g_{00} R = \frac{1}{2} R_{00} + \frac{1}{2} \frac{g_0}{g_1} R_{11} + \frac{g_0}{r^2} R_{22}$$

1. Compare  $R_{00}$  and  $R_{11}$  :

$$g'_0 = -\frac{g_0 g'_1}{g_1} \quad \frac{g'_0}{g_0} = -\frac{g'_1}{g_1}$$

$$\ln g_0 + \ln g_1 = \text{const}$$

$$g_0 g_1 = c^2 \quad (c = \text{velocity of light})$$

2.  $R_{22} = 0$

$$-\frac{g'_1}{g_1^2} + \frac{1}{r} \left( \frac{1}{g_1} - 1 \right) = 0$$

$$\left( \frac{1}{g_1} - 1 \right)'$$

$$\ln \left( \frac{1}{g_1} - 1 \right) + \ln r = \text{const}$$

$$\left( 1 - \frac{1}{g_1} \right) r = \alpha$$

$$g_1 = \frac{r}{r - \alpha} \quad g_0 = c^2 \left( 1 - \frac{\alpha}{r} \right)$$

$$ds^2 = c^2 \underbrace{\left( 1 - \frac{\alpha}{r} \right)}_{g_0} dt^2 - \underbrace{\frac{r}{r - \alpha}}_{g_1} dr^2 - r^2 d\vartheta^2 - r^2 \sin^2 \vartheta d\varphi^2$$

at large distance the space must become more and more Euklidian

precession of Mercury

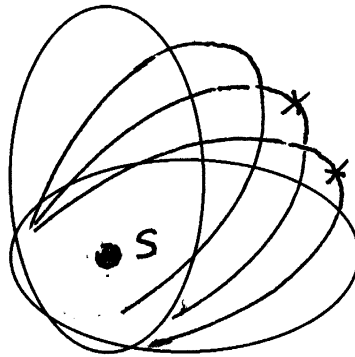

42" / century



$$ds^2 = \underbrace{c^2 \left(1 - \frac{\alpha}{r}\right)}_{g_0} dt^2 - \underbrace{\frac{r}{r-\alpha}}_{g_1} dr^2 - r^2 d\vartheta^2 - r^2 \sin^2 \vartheta d\varphi^2$$

$r \rightarrow \infty$   
 $\alpha \rightarrow 0$  }  $\rightarrow$  pseudo-Euklidian

Newton:  $R_{00} - \frac{1}{2} g_{00} R = \Delta \varphi$

$$-\frac{1}{2g_1} \left( g_0'' + \frac{2}{r} g_0' \right) \rightarrow -\frac{\Delta g_0}{2}$$

$$\varphi = -\frac{\gamma M}{r} + c_1 \qquad g_0 \approx -\frac{c^2 \alpha}{r} + c_2$$

$$\alpha = \frac{2\gamma M}{c^2}; \quad \alpha \sim M \qquad \frac{\alpha}{2} = \text{gravitation radius}$$

(for earth 5 mm)

Schnitt:  $t = \text{const}$

$$\vartheta = \frac{\pi}{2} \quad (\text{equatorial cut})$$

spacelike: sign.

Schnitt

$$d\sigma^2 = \frac{r}{\underbrace{r-\alpha}_{1+z'^2}} dr^2 + r^2 d\varphi^2 \quad (-ds^2)$$

rotation body

$$d\sigma^2 = (1+z'^2)dr^2 + r^2 d\varphi^2 \quad \leftarrow \quad \mathcal{U} = \begin{cases} r \cos \varphi \\ r \sin \varphi \\ z(r) \end{cases} \quad g_{11} = \mathcal{U}_r^2 = 1+z'^2 \quad g_{22} = \mathcal{U}_\varphi^2 = r^2$$

$$z' = \sqrt{\frac{\alpha}{r-\alpha}} \qquad z = 2\sqrt{\alpha(r-\alpha)}$$

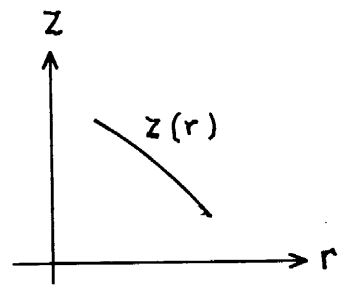
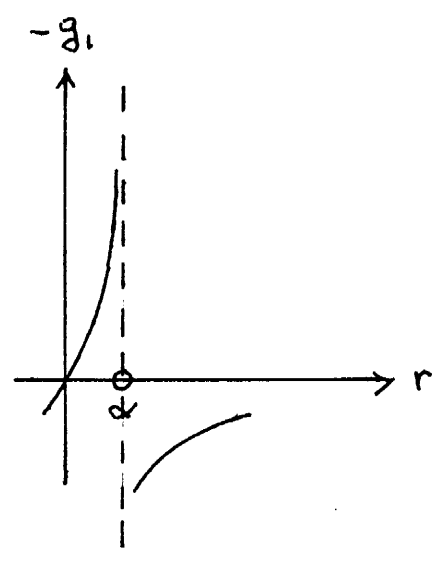
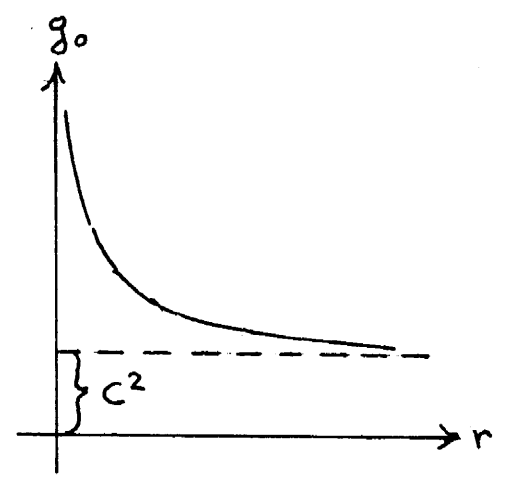
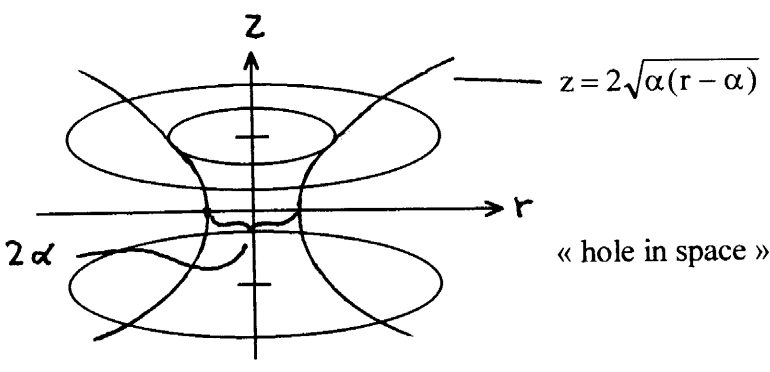

Two body problem

geodesic lines

$$\ddot{u}^i + \Gamma_{kl}^i \dot{u}^k \dot{u}^l = 0$$

yields  $\left( \begin{array}{l} \dot{\phantom{t}} = \frac{d}{ds} \\ \dot{\phantom{r}} = \frac{d}{dr} \end{array} \right)$

$$\left\{ \begin{array}{l} \ddot{t} = -\frac{g'_{00}}{g_{00}} \dot{t}^2 \\ \ddot{r} = -\frac{g'_{00}}{2g_{11}} \dot{t}^2 - \frac{g'_{11}}{2g_{11}} \dot{r}^2 + \frac{r}{g_{11}} \dot{\vartheta}^2 + \frac{r \sin^2 \vartheta}{g_{11}} \dot{\varphi}^2 \\ \ddot{\vartheta} = -\frac{2}{r} \dot{r} \dot{\vartheta} + \sin \vartheta \cos \vartheta \dot{\varphi}^2 \\ \ddot{\varphi} = -\frac{2}{r} \dot{r} \dot{\varphi} - \operatorname{ctg} \vartheta \dot{\vartheta} \dot{\varphi} \end{array} \right.$$

special case:  $\vartheta = \frac{\pi}{2}$ ,  $\dot{\vartheta} = 0$

$$\left\{ \begin{array}{l} 1.) \quad \ddot{t} = -\frac{g'_{00}}{g_{00}} \dot{t}^2 \\ 2.) \quad \ddot{r} = -\frac{g'_{00}}{2g_{11}} \dot{t}^2 - \frac{g'_{11}}{2g_{11}} \dot{r}^2 + \frac{r}{g_{11}} \dot{\varphi}^2 \\ 3.) \quad \ddot{\varphi} = -\frac{2}{r} \dot{r} \dot{\varphi} \end{array} \right.$$

from 1.)  $\frac{\ddot{t}}{\dot{t}} + \frac{\overbrace{g'_{00}}^{g_0}}{g_0} \dot{t} = 0$

$$\ln \dot{t} + \ln g_0 = \text{const}$$

$$\dot{t} g_0 = A \quad \left( = c^2 \frac{dt}{ds} - \frac{c^2 \alpha}{r} \frac{dt}{ds} \right) \quad \ll \text{energy theorem} \gg$$

from 3.)  $(r^2 \dot{\phi})^\bullet = 0$

$\alpha \quad r^2 \frac{d\phi}{ds} = B \quad \ll \text{surface theorem} \gg$

instead of 2.) !

$$ds^2 = g_0 dt^2 - g_1 dr^2 - r^2 d\phi^2 \quad \frac{1}{ds^2}$$

$$1 = \underbrace{g_0 \dot{t}^2} - g_1 \dot{r}^2 - \underbrace{r^2 \dot{\phi}^2}$$

$$\beta \quad g_1 \dot{r}^2 = \frac{A^2}{g_0} \quad - \frac{B^2}{r^2} - 1$$

$$\frac{\alpha}{\sqrt{\beta}} = \frac{r^2 \dot{\phi}}{\sqrt{g_1 \dot{r}^2}} = \frac{B}{\sqrt{A^2 / g_0 - B^2 / r^2 - 1}}$$

$$\frac{r^2 d\phi}{\sqrt{g_1} \cdot dr}$$

$$d\phi = \frac{B dr}{r^2 \sqrt{\frac{A^2}{c^2} - \frac{B^2}{r^2} \left(1 - \frac{\alpha}{r}\right) - \left(1 - \frac{\alpha}{r}\right)}}$$

$$\frac{1}{r} = \rho \quad - \frac{1}{r^2} dr = d\rho$$

$$\frac{1}{g_0 g_1} = \frac{1}{c^2 \frac{r-\alpha}{r} \cdot \frac{r}{r-\alpha}} = \frac{1}{c^2}$$

$$\int d\phi = \int \frac{-B d\rho}{\sqrt{\frac{A^2}{c^2} - B^2 \rho^2 (1 - \alpha\rho) - (1 - \alpha\rho)}}$$

elliptic integral

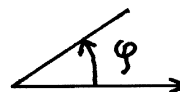

$\phi(r) \rightarrow r(\phi)$

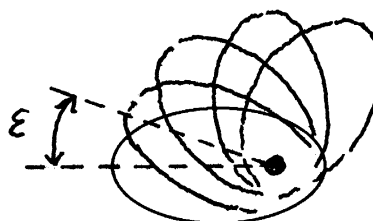
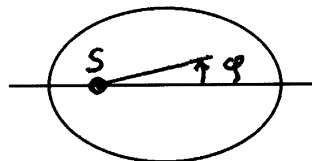
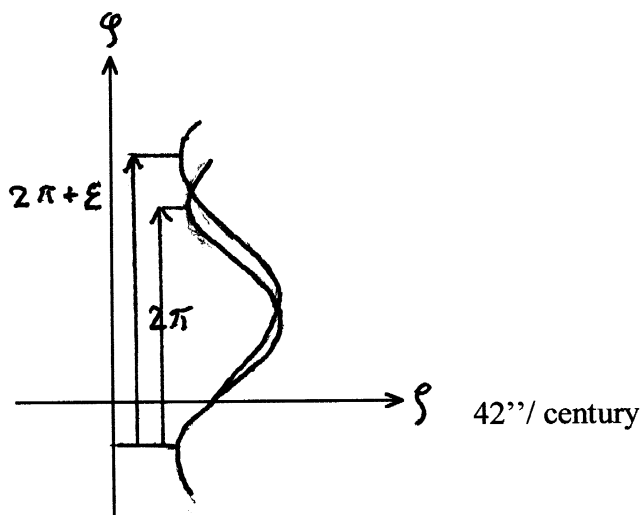

## Solution of the general gravitation equation

- 2 solutions: 1. cylindrical: Einstein  
2. spherically symmetric: de Sitter

Planet motion classical

$$K = -\gamma \frac{Mm}{r^2} \quad (m \ll M)$$

$$\begin{cases} x = r \cos \varphi \\ y = r \sin \varphi \end{cases} \quad \begin{cases} \dot{x} = \dot{r} \cos \varphi - r \sin \varphi \dot{\varphi} \\ \dot{y} = \dot{r} \sin \varphi + r \cos \varphi \dot{\varphi} \end{cases}$$

$$T = \frac{m}{2} v^2 = \frac{m}{2} (\dot{x}^2 + \dot{y}^2) = \frac{m}{2} (\dot{r}^2 + r^2 \dot{\varphi}^2)$$

$$U = -\gamma \frac{Mm}{r} \quad \left( K = -\text{grad}U = -\frac{dU}{dr} \right)$$

$$L = T - U = \frac{m}{2} (\dot{r}^2 + r^2 \dot{\varphi}^2) + \gamma \frac{Mm}{r}$$

$$1.) \frac{d}{dt} L_{\dot{r}} - L_r = m \left( \ddot{r} - r \dot{\varphi}^2 + \frac{\gamma M}{r^2} \right) = 0 \quad | \cdot 2\dot{r}$$

$$2.) \frac{d}{dt} L_{\dot{\varphi}} - L_{\varphi} = m (r^2 \dot{\varphi})^{\cdot} = 0$$

from 2.)  $r^2 \dot{\varphi} = A$  « surface theorem » 2nd Kepler's law

$$F = \frac{1}{2} \int_{\varphi(t_1)}^{\varphi(t_2)} r^2 d\varphi = \frac{1}{2} \int_{t_1}^{t_2} A dt = \frac{1}{2} A (t_2 - t_1)$$

(redshift)

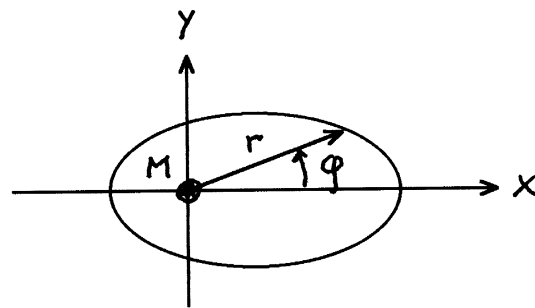

$$\varphi = -\frac{\gamma M}{r} + \varphi_1$$

= 0 Schmitt

$$\Delta \varphi = 4\pi \gamma \rho$$

$$\mathcal{K} = -m \text{grad} \varphi$$

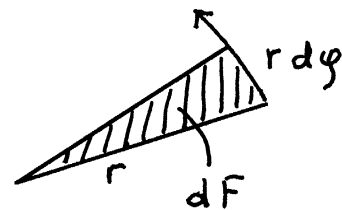

from 1.)

$$2\ddot{r}\dot{r} - 2\dot{r}\dot{\phi}^2 + 2\gamma M \frac{\dot{r}}{r^2} = 0$$

$$\underbrace{\quad}_{\frac{A^2}{r^3}}$$

$$\frac{d}{dt} \left( \dot{r}^2 + \frac{A^2}{r^2} - 2\gamma M \frac{1}{r} \right) = 0$$

$$\frac{m}{2} \left( \dot{r}^2 + \frac{A^2}{r^2} - 2\gamma M \frac{1}{r} \right) = T + U = B \bullet m \quad \text{energy theorem}$$

$$\underbrace{\quad}_{r^2 \dot{\phi}^2}$$

$$\frac{\dot{r}}{\dot{\phi}} = r' = \frac{\sqrt{2B - \frac{A^2}{r^2} + \frac{2\gamma M}{r}}}{A/r^2} \quad \left( ' = \frac{d}{d\phi} \right)$$

$$\int d\phi = \int \frac{A dr}{r \sqrt{2Br^2 - A^2 + 2\gamma Mr}} \quad r = \frac{1}{\rho}$$

$$\phi - \phi_0 = \arccos \left( \frac{A^2 - \gamma Mr}{r \sqrt{2A^2 B + \gamma^2 M^2}} \right)$$

$$r = \frac{A^2 / \gamma M}{1 + \underbrace{\sqrt{\frac{2A^2 B}{\gamma^2 M^2} + 1}}_{< 1} \cos(\phi - \phi_0)} \rightarrow \text{ellipse}$$

$$\hookrightarrow = \infty$$

$$\int d\phi = \int \frac{-A d\rho}{\sqrt{2B - A^2 \rho^2 + 2\gamma M \rho}}$$

N.B. Here A and B are not the same as those introduced in the previous calculations.

A: surface theorem ; B: energy conservation

Farther below, to make the distinction, they will be denoted as  $A_K, B_K$

Kepler ellipse as the Newtonian limit of the Schwarzschild trajectory.

Kepler- Newton:

$$(1) \int d\phi = \int \frac{-A_K d\rho}{\sqrt{2B_K - A_K^2 \rho^2 + 2\gamma M \rho}}$$

with  $B_K = \frac{T+U}{m} = \frac{E}{m}$  and E the Newtonian energy

Schwarzschild:

$$(2) \int d\phi = \int \frac{-B d\rho}{\sqrt{\frac{A^2}{c^2} - B^2 \rho^2 (1 - \alpha \rho) - 1 + \frac{2\gamma M}{c^2} \rho}}$$

The Newtonian limit means neglecting the term in  $\rho^3$  under the square root:

$$(3) \int d\phi = \int \frac{-B d\rho}{\sqrt{\frac{A^2}{c^2} - B^2 \rho^2 - 1 + \frac{2\gamma M}{c^2} \rho}}$$

Furthermore in this limit we set

$$\frac{A}{c} = \frac{E + mc^2}{mc^2} = 1 + \frac{E}{mc^2} \quad \text{yielding} \quad \frac{A^2}{c^2} = \left(1 + \frac{E}{mc^2}\right)^2 \approx 1 + \frac{2E}{mc^2}$$

Eq.(3) thus takes the form

$$(4) \int d\phi = \int \frac{-B d\rho}{\sqrt{\cancel{1} + \frac{2E}{mc^2} - B^2 \rho^2 - \cancel{1} + \frac{2\gamma M}{c^2} \rho}}$$

and finally, with  $B_K = \frac{E}{m}$

$$(5) \int d\phi = \int \frac{-B c d\rho}{\sqrt{2B_K - (Bc)^2 \rho^2 + 2\gamma M \rho}}$$

Setting  $Bc = A_K$  we thus recover eq.(1).

## Gravitational lensing

A remarkable effect of general relativity is the bending of a light beam in the vicinity of a mass, also known as gravitational lensing. We treat this problem by assuming the Schwarzschild

metric with the beam moving in the horizontal plane, i.e.  $\vartheta = \frac{\pi}{2}$ ,  $\sin^2 \vartheta = 1$ . We further set

$ds^2 = 0$  meaning that the light travels on a line of constant proper time. Then the first ground form reduces to

$$0 = c^2 \left(1 - \frac{\alpha}{r}\right) dt^2 - \frac{r}{r-\alpha} dr^2 - r^2 d\varphi^2 \quad \text{or}$$

$$d\bar{s}^2 = c^2 dt^2 = \frac{1}{\left(1 - \frac{\alpha}{r}\right)^2} dr^2 + \frac{r^2}{1 - \frac{\alpha}{r}} d\varphi^2$$

The expressions for the metric tensor are therefore

$$g_{ik} = \begin{pmatrix} \frac{1}{\left(1 - \frac{\alpha}{r}\right)^2} & 0 \\ 0 & \frac{r^2}{1 - \frac{\alpha}{r}} \end{pmatrix} \quad g^{ik} = \begin{pmatrix} \left(1 - \frac{\alpha}{r}\right)^2 & 0 \\ 0 & \frac{1 - \frac{\alpha}{r}}{r^2} \end{pmatrix} \quad g = \frac{r^2}{\left(1 - \frac{\alpha}{r}\right)^3}$$

Now we assume that the light travels on a geodesic line. In order to establish the corresponding equations, we need the Christoffel symbols. These are calculated from their definition in terms of derivatives of the metric tensor. For the non zero elements we obtain in this way

$$\Gamma_{11}^1 = \frac{-\alpha}{r(r-\alpha)} \quad \Gamma_{22}^1 = -\frac{1}{2}(2r-3\alpha) \quad \Gamma_{12}^2 = \Gamma_{21}^2 = \frac{1}{2} \frac{2r-3\alpha}{r(r-\alpha)}$$

With these values the equations of the geodesics

$$\begin{aligned} r'' + \Gamma_{11}^1 r'^2 + \Gamma_{22}^1 \varphi'^2 &= 0 \\ \varphi'' + 2\Gamma_{12}^2 r' \varphi' &= 0 \end{aligned} \quad ' = \frac{d}{d\bar{s}}$$

are thus given by

$$r'' = \frac{\alpha}{r(r-\alpha)} r'^2 + \frac{1}{2}(2r-3\alpha) \varphi'^2$$

$$\varphi'' = -\frac{2r-3\alpha}{r(r-\alpha)} r' \varphi'$$

The second equation written in the form

$$\frac{\varphi''}{\varphi'} = -\frac{2r-3\alpha}{r(r-\alpha)} r'$$

can be integrated immediately over  $\bar{s}$  yielding

$$\ln \varphi' = \ln \frac{r-\alpha}{r^3} + \text{const} \quad \text{and hence}$$

$$\varphi' = K \frac{r-\alpha}{r^3} \quad \text{with } K \text{ a constant to be determined later.}$$

The expression for  $r'$  can be obtained by going back to the metric equation and dividing it by  $d\bar{s}^2$  so that we have

$$1 = \frac{r^2}{(r-\alpha)^2} r'^2 + \frac{r^3}{r-\alpha} \varphi'^2$$

and further, by substituting for  $\varphi'$  the expression derived above,

$$1 = \frac{r^2}{(r-\alpha)^2} r'^2 + K^2 \frac{r-\alpha}{r^3}$$

The constant  $K$  can be expressed in terms of the distance of closest approach  $b$ , termed the impact parameter. At this particular point the variation of  $r$  is of second order, meaning that  $r' = 0$ . Then with  $r = b$  the above equation yields the value

$$K = \sqrt{\frac{b^3}{b-\alpha}}$$

Our equation can now be solved for  $r'$ ; together with  $\varphi'$  already known we thus obtain

$$r' = \frac{r-\alpha}{r} \sqrt{1 - \frac{b^3}{b-\alpha} \frac{r-\alpha}{r^3}} \quad \varphi' = \sqrt{\frac{b^3}{b-\alpha}} \frac{r-\alpha}{r^3}$$

Taking the ratio of these two quantities we write

$$\frac{\varphi'}{r'} = \frac{d\varphi}{dr} = \sqrt{\frac{b^3}{b-\alpha}} \frac{1}{r^2 \sqrt{1 - \frac{b^3}{b-\alpha} \frac{r-\alpha}{r^3}}} = \frac{1}{r^2 \sqrt{\frac{1}{b^2} - \frac{1}{r^2} - \alpha \left( \frac{1}{b^3} - \frac{1}{r^3} \right)}}$$

Integration then yields  $\varphi$  as a function of  $r$ . Considering the total change in the angle  $\varphi$  we integrate over  $r$  from  $-\infty$  to  $+\infty$  but conveniently split the integral in a part from  $-\infty$  to  $b$  and one from  $b$  to  $+\infty$ . For symmetry reasons the two parts are equal so that we just count the second part twice. To perform the integration we introduce as a new variable the ratio  $\rho = \frac{b}{r}$ .

Then the integration limits corresponding to  $r = b$  and  $r = -\infty$  are respectively  $\rho = 1$  and



$\rho = 0$ . In this way we obtain for the change  $\Delta\phi$  during the entire trajectory, after some algebra, the expression

$$\Delta\phi = 2 \int_0^1 \frac{d\rho}{\sqrt{1-\rho^2 - \frac{\alpha}{b}(1-\rho^3)}}$$

Note that it is clear from this expression that if  $b$  is smaller than  $\alpha$ , i. e. if the beam passes at very close distances from the center of the mass, the quantity under the root can become negative, meaning physically that the light gets trapped, a phenomenon known as black hole. Here we consider only weak gravitational fields, in which case  $\Delta\phi$  can be expanded to first order in  $\alpha$  yielding

$$\Delta\phi = 2 \int_0^1 \frac{d\rho}{\sqrt{1-\rho^2}} \left( 1 + \frac{1}{2} \frac{\alpha}{b} \frac{1-\rho^3}{1-\rho^2} \right)$$

For the first term we have

$$2 \int_0^1 \frac{d\rho}{\sqrt{1-\rho^2}} = 2 |\arcsin \rho|_0^1 = \pi$$

this corresponds just to the straight line trajectory in the absence of any interaction.

The second term accounts for the deviation angle from this trajectory. The integral involved can be done exactly with the result

$$\int_0^1 \frac{1-\rho^3}{(1-\rho^2)^{3/2}} d\rho = \left| -\frac{\sqrt{1-\rho}}{\sqrt{1+\rho}} - \sqrt{1-\rho^2} \right|_0^1 = 2$$

and hence we find in the end

$$\Delta\phi = \pi + 2 \frac{\alpha}{b} = \pi + \delta$$

Inserting the value  $\alpha = \frac{2\gamma M}{c^2}$  we see that the bending of the trajectory due to the presence of

gravitation is represented by the deviation

$$\delta = \frac{4\gamma M}{c^2 b}$$

This effect has been observed first by Eddington in 1919 during a solar eclipse and has ever since been regarded as a strong support for Einstein's theory of gravitation.

### Gravitational redshift

We consider a light beam travelling between an emitting observer placed at a distance  $r$  from a mass  $M$  and a receiving observer placed at a very large distance i.e. practically at infinity.

Assuming that both observers are at rest, we write the Schwarzschild metric in the form

$$c^2 d\tau^2 = \left(1 - \frac{\alpha}{r}\right) c^2 dt^2 \quad c^2 dt^2 = \left(1 - \frac{\alpha}{r}\right)^{-1} c^2 d\tau^2$$

and define a velocity

$$u^2 = \left(1 - \frac{\alpha}{r}\right)^{-1} c^2$$

Hence the velocities referring to the two observers are

$$u = \left(1 - \frac{\alpha}{r}\right)^{-1/2} c \quad \text{and} \quad u_\infty = c$$

Since the photon travels on a geodesic line, his momentum is conserved and his energy  $E$  therefore varies according to the ratio of the two velocities. Using the relation  $E = \hbar\omega$  we thus find

$$\frac{E_\infty}{E} = \frac{\omega_\infty}{\omega} = \frac{u_\infty}{u} = \left(1 - \frac{\alpha}{r}\right)^{1/2} \approx 1 - \frac{\alpha}{2r} \quad \text{with} \quad \alpha = \frac{2\gamma M}{c^2}$$

This shows that a light beam moving away from a large mass suffers a redshift approximately proportional to that mass.

## **EXERCISES**

**EX2** Interpreting the system of equations

$$x = u + v$$

$$y = v$$

as point- as well as coordinate transformation

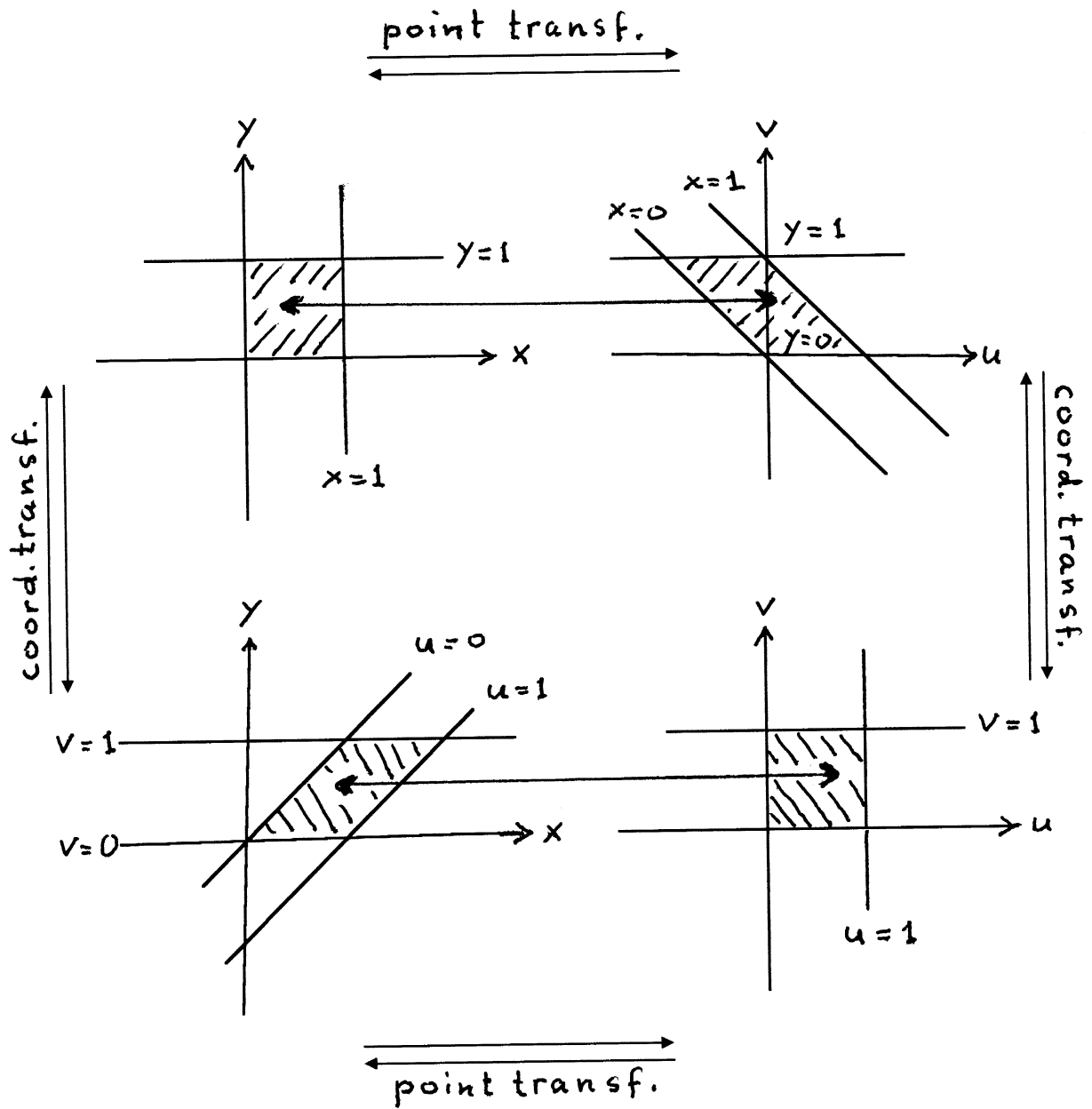

EX3 Given the space curve

$$\mathbf{r}(t) = (\sin t, -\sqrt{1-t^2}, \cos t)$$

determine  $s(t)$ ,  $\kappa(t)$ ,  $\tau(t)$

i.e. arch length, curvature, torsion.

$$s(t) = s(0) + \int_0^t \sqrt{(\dot{x}^1)^2 + (\dot{x}^2)^2 + (\dot{x}^3)^2} dt$$

$$\dot{x}^1 = \cos t$$

$$s(0) = 0; \quad \dot{x}^2 = \frac{t}{\sqrt{1-t^2}}$$

$$\dot{x}^3 = -\sin t$$

$$s(t) = \int_0^t \sqrt{1 + \frac{t^2}{1-t^2}} dt = \int_0^t \frac{dt}{\sqrt{1-t^2}}$$

$s(t) = \arcsin t$  : length of the curve:  $s(1) - s(-1) = \pi$ , as long as half the unit circle.

$$\kappa(t) = \frac{|\dot{\mathbf{r}} \ddot{\mathbf{r}}|}{|\dot{\mathbf{r}}|^3}$$

$$\dot{\mathbf{r}}(t) = \begin{pmatrix} \cos t \\ \frac{t}{\sqrt{1-t^2}} \\ -\sin t \end{pmatrix} \quad \ddot{\mathbf{r}}(t) = \begin{pmatrix} -\sin t \\ \frac{1}{\sqrt{1-t^2}^3} \\ -\cos t \end{pmatrix}$$

$$|\dot{\mathbf{r}} \ddot{\mathbf{r}}| = \begin{cases} -\frac{t}{\sqrt{1-t^2}} \cos t + \frac{1}{\sqrt{1-t^2}^3} \sin t \\ \sin^2 t + \cos^2 t = 1 \\ \frac{1}{\sqrt{1-t^2}^3} \cos t + \frac{t}{\sqrt{1-t^2}} \sin t \end{cases}$$

$$|\dot{\mathbf{r}} \ddot{\mathbf{r}}|^2 = \frac{t^4 - 2t^2 + 2}{(1-t^2)^3} \quad |\dot{\mathbf{r}}| = \frac{1}{\sqrt{1-t^2}} \quad \frac{1}{|\dot{\mathbf{r}}|^3} = \sqrt{1-t^2}^3$$

$$\kappa(t) = \sqrt{t^4 - 2t^2 + 2} = \sqrt{1 + (1-t^2)^2} \quad \kappa(s) = \sqrt{1 + \cos^4 s} \quad \text{since } t = \sin s$$

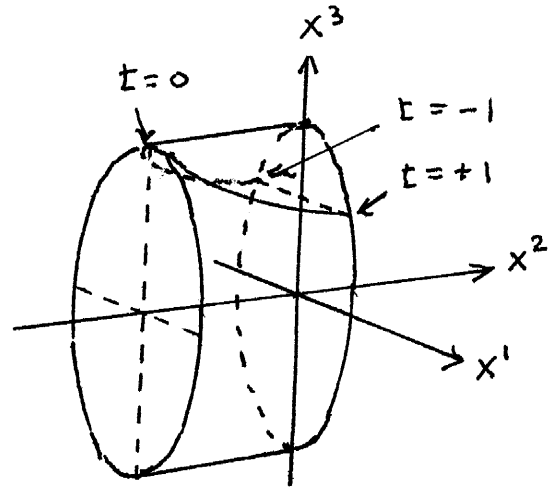

$$\tau(t) = \frac{\langle \dot{\mathbf{r}} \ddot{\mathbf{r}} \ddot{\mathbf{r}} \rangle}{[\dot{\mathbf{r}} \ddot{\mathbf{r}}]^2} \quad \ddot{\mathbf{r}}(t) = \begin{cases} -\cos t \\ 3t \\ \sqrt{1-t^2}^5 \\ \sin t \end{cases}$$

$$\langle \dot{\mathbf{r}} \ddot{\mathbf{r}} \ddot{\mathbf{r}} \rangle = \ddot{\mathbf{r}}[\dot{\mathbf{r}} \ddot{\mathbf{r}}] = \frac{t(t^4 - 2t^2 + 4)}{\sqrt{1-t^2}^5}$$

$$\tau(t) = \frac{t(t^4 - 2t^2 + 4)}{t^4 - 2t^2 + 2} \sqrt{1-t^2} \quad \tau(s) = \frac{\sin s (3 + \cos^4 s)}{1 + \cos^4 s} \cos s$$

$$\kappa(0) = \sqrt{2} \quad \tau(0) = 0 = \tau(\pm 1)$$

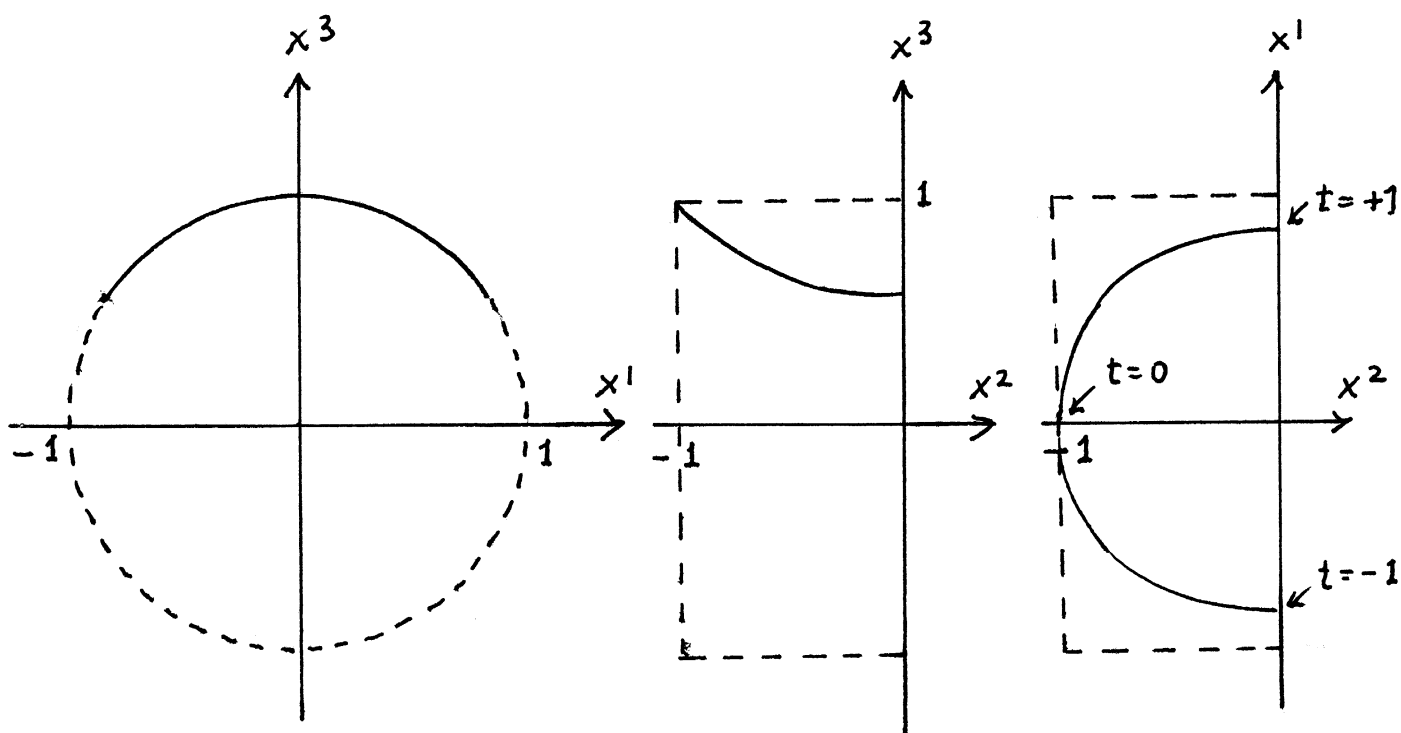

## EX4 First groundform; transition to isotherm parameters

1) Cone

parameters  $u, v$  (polar coordinates)

$\mathcal{r}$	$\mathcal{r}_u$	$\mathcal{r}_v$
$u \cos v$	$\cos v$	$-u \sin v$
$u \sin v$	$\sin v$	$u \cos v$
$\cot \alpha \cdot u$	$\cot \alpha$	$0$

$$g_{ik} = \begin{pmatrix} \frac{1}{\sin^2 \alpha} & 0 \\ 0 & u^2 \end{pmatrix} \quad g = \frac{u^2}{\sin^2 \alpha} \quad g_{12}, g_{21} = 0 \quad \text{parameter lines are orthogonal}$$

$$ds^2 = \frac{1}{\sin^2 \alpha} du^2 + u^2 dv^2$$

Transition to isotherm parameters

$\mathcal{r}$	$\mathcal{r}_u$	$\mathcal{r}_v$
$\psi(u) \cos v$	$\psi' \cos v$	$-\psi \sin v$
$\psi(u) \sin v$	$\psi' \sin v$	$\psi \cos v$
$\cot \alpha \cdot \psi(u)$	$\cot \alpha \cdot \psi'$	$0$

$$g_{ik} = \begin{pmatrix} \psi'^2 \cdot \frac{1}{\sin^2 \alpha} & 0 \\ 0 & \psi^2 \end{pmatrix}$$

$$\text{isotherm parameters: } \psi'^2 \cdot \frac{1}{\sin^2 \alpha} = \psi^2; \quad \psi' = \sin \alpha \cdot \psi \quad \psi = e^{\sin \alpha \cdot u}$$

$$g_{11} = g_{22} = e^{2 \sin \alpha \cdot u} \quad ds^2 = e^{2 \sin \alpha \cdot u} (du^2 + dv^2); \quad g = e^{4 \sin \alpha \cdot u}$$

$$\mathcal{r} = \begin{cases} e^{\sin \alpha \cdot u} \cos v \\ e^{\sin \alpha \cdot u} \sin v \\ \cot \alpha \cdot e^{\sin \alpha \cdot u} \end{cases}$$

2) Rotation paraboloid

a) polar coordinates  $u, v$  as parameters

$\mathcal{r}$	$\mathcal{r}_u$	$\mathcal{r}_v$
$u \cos v$	$\cos v$	$-u \sin v$
$u \sin v$	$\sin v$	$u \cos v$
$au^2$	$2au$	$0$

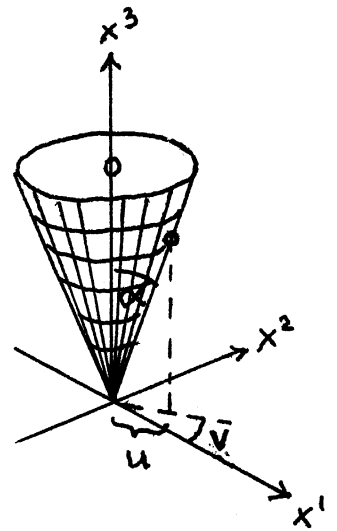
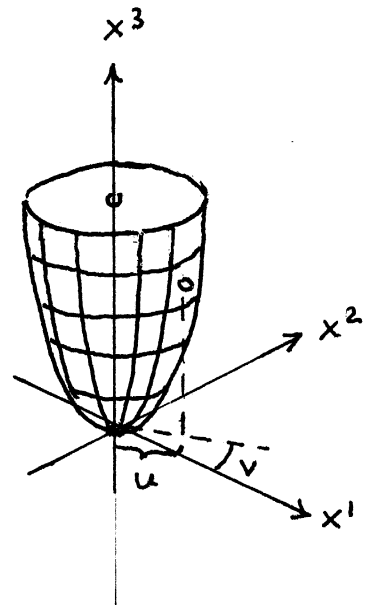

$$g_{ik} = \begin{pmatrix} 1 + 4a^2 u^2 & 0 \\ 0 & u^2 \end{pmatrix} \quad g = u^2 + 4a^2 u^4$$

$$ds^2 = (1 + 4a^2 u^2) du^2 + u^2 dv^2$$

Transition to isotherm parameters

$\mathcal{r}$	$\mathcal{r}_u$	$\mathcal{r}_v$
$\psi(u) \cos v$	$\psi' \cos v$	$-\psi \sin v$
$\psi(u) \sin v$	$\psi' \sin v$	$\psi \cos v$
$a\psi^2$	$2a\psi\psi'$	$0$

$$g_{ik} = \begin{pmatrix} \psi'^2 (1 + 4a^2 \psi^2) & 0 \\ 0 & \psi^2 \end{pmatrix}$$

isotherm parameters:  $\psi'^2 (1 + 4a^2 \psi^2) = \psi^2 \quad \psi' = \frac{\psi}{\sqrt{1 + 4a^2 \psi^2}}$

$$\int \frac{\sqrt{1 + 4a^2 \psi^2}}{\psi} d\psi = \int du$$

$$u = \sqrt{1 + 4a^2 \psi^2} - \text{Other logs} \sqrt{1 + 4a^2 \psi^2}$$

$\psi = \psi(u)$  cannot be solved explicitly.

b) Other parameters  $x^1 = u; \quad x^2 = v$

$\mathcal{r}$	$\mathcal{r}_u$	$\mathcal{r}_v$
$u$	$1$	$0$
$v$	$0$	$1$
$a(u^2 + v^2)$	$2au$	$2av$

$$g_{ik} = \begin{pmatrix} 1 + 4a^2 u^2 & 4a^2 uv \\ 4a^2 uv & 1 + 4a^2 v^2 \end{pmatrix} \quad g = 1 + 4a^2 (u^2 + v^2)$$

$g_{12} = g_{21} \neq 0$  parameter lines are not orthogonal

$$ds^2 = (1 + 4a^2 u^2) du^2 + 8a^2 uvdudv + (1 + 4a^2 v^2) dv^2$$

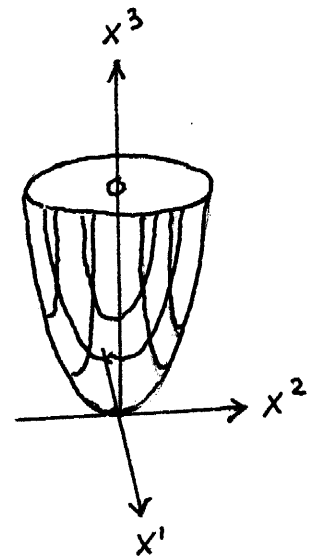



EX6 Torus. Parameters are the angles  $u, v$ , see figure

$\mathcal{r}$	$\mathcal{r}_u$	$\mathcal{r}_v$
$(R + r \cos v) \cos u$	$-(R + r \cos v) \sin u$	$-r \sin v \cos u$
$(R + r \cos v) \sin u$	$(R + r \cos v) \cos u$	$-r \sin v \sin u$
$r \sin v$	0	$r \cos v$
$\mathcal{r}_{uu}$	$\mathcal{r}_{uv}$	$\mathcal{r}_{vv}$
$-(R + r \cos v) \cos u$	$r \sin v \sin u$	$-r \cos v \cos u$
$-(R + r \cos v) \sin u$	$-r \sin v \cos u$	$-r \cos v \sin u$
0	0	$-r \sin v$

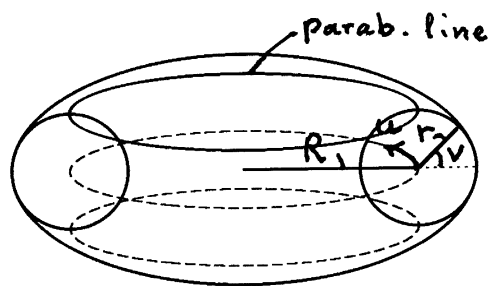

$$g_{ik} = \begin{pmatrix} (R + r \cos v)^2 & 0 \\ 0 & r^2 \end{pmatrix} \quad g = r^2 (R + r \cos v)^2$$

$$I = ds^2 = (R + r \cos v)^2 du^2 + r^2 dv^2$$

$$[\mathcal{r}_u \mathcal{r}_v] = \begin{cases} (R + r \cos v) \cos u \cdot r \cos v \\ (R + r \cos v) \sin u \cdot r \cos v \\ (R + r \cos v) r \sin v \end{cases}$$

$$\langle \mathcal{r}_u \mathcal{r}_v \mathcal{r}_{uu} \rangle = -(R + r \cos v)^2 r \cos v$$

$$\langle \mathcal{r}_u \mathcal{r}_v \mathcal{r}_{uv} \rangle = 0$$

$$\langle \mathcal{r}_u \mathcal{r}_v \mathcal{r}_{vv} \rangle = -(R + r \cos v) r^2$$

$$b_{ik} = \begin{pmatrix} -(R + r \cos v) \cos v & 0 \\ 0 & -r \end{pmatrix}$$

$$\Pi = -(R + r \cos v) \cos v du^2 - r dv^2$$

$$b = (R + r \cos v) r \cos v$$

$$b > 0 \quad -\frac{\pi}{2} < v < \frac{\pi}{2} \quad \text{elliptic curvature}$$

$$b < 0 \quad \frac{\pi}{2} < v < \frac{3\pi}{2} \quad \text{hyperbolic curvature}$$

$$b = 0 \quad v = \frac{\pi}{2} = \frac{3\pi}{2} \quad \text{parabolic curvature}$$

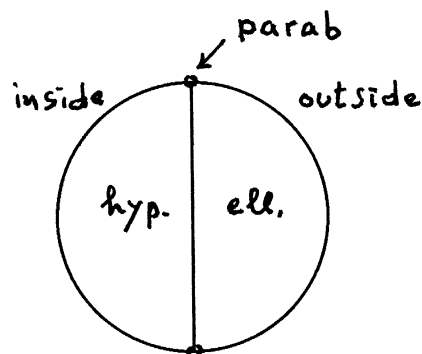

**EX8 .Transformation of other quantities**a.) Basis vectors  $\mathbf{u}_1, \mathbf{u}_2 \rightarrow \bar{\mathbf{u}}_1, \bar{\mathbf{u}}_2$ 

From the figure we deduce

$$\bar{\mathbf{u}}_1 = \cos \alpha \mathbf{u}_1 - \sin \alpha \mathbf{u}_2$$

$$\bar{\mathbf{u}}_2 = \cos \alpha \mathbf{u}_1 + \sin \alpha \mathbf{u}_2$$

yielding the transformation matrix

$$D = \begin{pmatrix} \cos \alpha & -\sin \alpha \\ \cos \alpha & \sin \alpha \end{pmatrix} \quad \text{covariant}$$

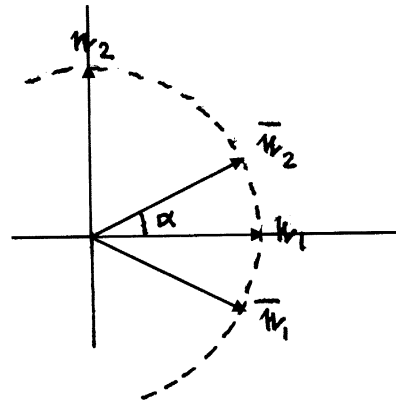

b.) Reciprocal basis vectors.

Defining relations:  $\mathbf{u}_j \cdot \mathbf{u}^k = \delta_j^k$  for the cartesian and the oblique frame respectively.  
 $\bar{\mathbf{u}}_j \cdot \bar{\mathbf{u}}^k = \delta_j^k$

The first relation is automatically fulfilled Now set

$$\bar{\mathbf{u}}^k = B_{km} \mathbf{u}_m \quad \text{with } D_{jl} \text{ the elements of the matrix } D \text{ introduced above.}$$

$$\bar{\mathbf{u}}_j = D_{jl} \mathbf{u}_l$$

Then we obtain from the defining relation

$$\bar{\mathbf{u}}_j \cdot \bar{\mathbf{u}}^k = D_{jl} B_{km} \mathbf{u}_l \cdot \mathbf{u}_m = D_{jl} B_{kl} = \delta_j^k. \quad \text{using } \mathbf{u}_l \cdot \mathbf{u}_m = \delta_{lm}$$

i.e.the orthogonality of the vectors in the cartesian frame.

Introducing the transposed matrix  $B^+$  we have

$D_{jl} B_{lk}^+ = \delta_j^k$  meaning that  $B^+$  is the reciprocal of  $D$ . By inverting  $D$  we therefore find

$$B^+ = \begin{pmatrix} \frac{1}{2 \cos \alpha} & \frac{1}{2 \cos \alpha} \\ -\frac{1}{2 \sin \alpha} & \frac{1}{2 \sin \alpha} \end{pmatrix} \quad \text{yielding for the transformation matrix the final result}$$

$$B = \begin{pmatrix} \frac{1}{2 \cos \alpha} & -\frac{1}{2 \sin \alpha} \\ \frac{1}{2 \cos \alpha} & \frac{1}{2 \sin \alpha} \end{pmatrix} \quad \text{contravariant}$$

Geometrical interpretation: According to this result the cartesian components of the vectors

$\bar{\mathbf{u}}^1, \bar{\mathbf{u}}^2$  are respectively given by the first and the second line of the matrix  $B$ .

1.) The lengths of the vectors are

$$\left| \bar{\mathbf{u}}^1 \right| = \left| \bar{\mathbf{u}}^2 \right| = \frac{1}{\sin 2\alpha}$$

2.) Let  $\gamma$  be the angle between  $\bar{u}^1, \bar{u}^2$  respectively and the horizontal axis. Then, according to the transformation relation,  $\text{tg} \gamma = \cot \alpha \rightarrow \gamma = 90^\circ - \alpha$ .

Hence for  $0 < \alpha < \frac{\pi}{2}$  the angle between  $\bar{u}^1, \bar{u}^2$  and the vertical is  $\alpha$  again. For

$\alpha = 45^\circ$  the vectors are coincident with the axis and are of unit length.

3.) Plotting the vectors  $\bar{u}^1, \bar{u}^2$  in a diagram for different values of  $\alpha$  one obtains a figure symmetric about the axis  $\alpha = \pm \frac{\pi}{4}$ . The extremities of the vectors

lie on a curve which has asymptotes parallel to the axis at distance equal  $\frac{1}{2}$ .

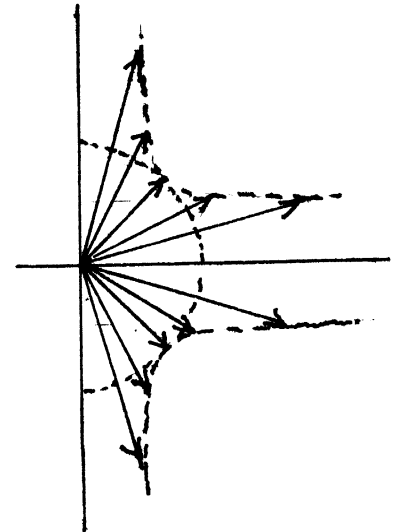

c.) Reciprocal coordinates. Defining relation:  $\sigma_i u^i = \bar{\sigma}_i \bar{u}^i$

We multiply this equation with  $\bar{u}_k$  to obtain

$$\sigma_i u^i \cdot \bar{u}_k = \bar{\sigma}_i \quad \text{where the relation } \bar{u}^i \bar{u}_k = \delta_k^i \text{ has been used.}$$

Substituting  $\bar{u}_k = D_{kj} u_j$  in this equation yields with  $u^i \cdot u_j = \delta_j^i$

$$\bar{\sigma}_i = \sigma_j D_{kj} \quad u^i \cdot u_j = \delta_{ki} \sigma_i$$

Thus  $\bar{\sigma}_i$  and  $\sigma_i$  are related according to the covariant matrix D.

d.) Vertical lengths  $l^{(i)}$

From the figure we immediately deduce

$$\bar{l}^{(1)} = \sin \alpha \cdot l^{(1)} - \cos \alpha \cdot l^{(2)}$$

$$\bar{l}^{(2)} = \sin \alpha \cdot l^{(1)} + \cos \alpha \cdot l^{(2)}$$

Thus the transformation property is neither co - nor contravariant.

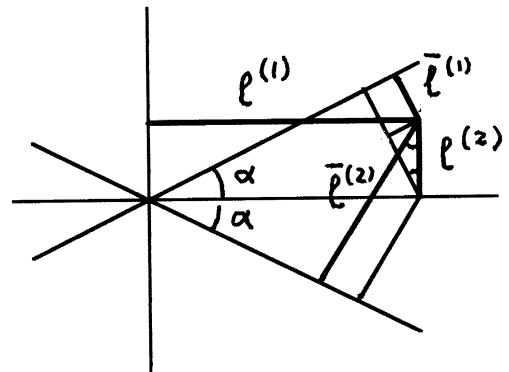

e.) Vertical replacement quantities.

Defining relations:  $\frac{\bar{l}^{(i)}}{\sin 2\alpha} = \bar{l}^i, \quad l^{(i)} = l^i$  Dividing the

equations (I) by  $\sin 2\alpha = 2 \sin \alpha \cos \alpha$  yields

$$\frac{\bar{l}^{(1)}}{\sin 2\alpha} = \bar{l}^1 = \frac{l^{(1)}}{2 \cos \alpha} - \frac{l^{(2)}}{2 \sin \alpha}$$

$$\frac{\bar{l}^{(2)}}{\sin 2\alpha} = \bar{l}^2 = \frac{l^{(1)}}{2 \cos \alpha} + \frac{l^{(2)}}{2 \sin \alpha}$$

meaning contravariant transformation.

**EX9** Mutual relations between components of the vector  $\bar{\lambda}$  and their modification by transitions to a new coordinate system.

- |   |   |
|---|---|
| 1.) Natural contravariant components defined by | $\bar{\lambda} = \nu_k \lambda_{(\omega)}^k$      |
| 2.) Contravariant components defined by         | $\bar{\lambda} = \zeta_k \lambda^k$               |
| 3.) Natural covariant components defined by     | $\lambda_{(\omega)k} = \nu_k \cdot \bar{\lambda}$ |
| 4.) Covariant components defined by             | $\lambda_k = \zeta_k \cdot \bar{\lambda}$         |

1.)	2.)	3.)	4.)
1.) $\bar{\lambda}_{(\omega)}^1 = \frac{\sqrt{g_{ii}}}{\sqrt{g_{kk}}} \frac{\partial \bar{u}^1}{\partial u^k} \lambda_{(\omega)}^k$ $\lambda_{(\omega)}^k = \frac{\sqrt{g_{kk}}}{\sqrt{g_{ii}}} \frac{\partial u^k}{\partial \bar{u}^1} \bar{\lambda}_{(\omega)}^1$	$\lambda_{(\omega)}^k = \sqrt{g_{kk}} \lambda^k$	$\lambda_{(\omega)}^1 = \sqrt{g_{ii}} \sqrt{g_{mm}} g^{lm} \lambda_{(\omega)m}$	$\lambda_{(\omega)}^1 = \sqrt{g_{ii}} g^{lm} \lambda_m$
2.) $\lambda^k = \frac{1}{\sqrt{g_{kk}}} \lambda_{(\omega)}^k$	$\bar{\lambda}^1 = \frac{\partial \bar{u}^1}{\partial u^k} \lambda^k$ $\lambda^k = \frac{\partial u^k}{\partial \bar{u}^1} \bar{\lambda}^1$	$\lambda^1 = g^{lm} \sqrt{g_{mm}} \lambda_{(\omega)m}$	$\lambda^1 = g^{lm} \lambda_m$
3.) $\lambda_{(\omega)k} = \frac{1}{\sqrt{g_{kk}}} \frac{1}{\sqrt{g_{ii}}} g_{kl} \lambda_{(\omega)l}^1$	$\lambda_{(\omega)k} = \frac{1}{\sqrt{g_{kk}}} g_{kl} \lambda^l$	$\bar{\lambda}_{(\omega)1} = \frac{\sqrt{g_{kk}}}{\sqrt{g_{ii}}} \frac{\partial u^k}{\partial \bar{u}^1} \lambda_{(\omega)k}$ $\lambda_{(\omega)k} = \frac{\sqrt{g_{ii}}}{\sqrt{g_{kk}}} \frac{\partial \bar{u}^1}{\partial u^k} \bar{\lambda}_{(\omega)1}$	$\lambda_{(\omega)k} = \frac{1}{\sqrt{g_{kk}}} \lambda_k$
4.) $\lambda_k = g_{kl} \frac{1}{\sqrt{g_{ii}}} \lambda_{(\omega)l}^1$	$\lambda_k = g_{kl} \lambda^l$	$\lambda_k = \sqrt{g_{kk}} \lambda_{(\omega)k}$	$\bar{\lambda}_1 = \frac{\partial u^k}{\partial \bar{u}^1} \lambda_k$ $\lambda_k = \frac{\partial \bar{u}^1}{\partial u^k} \bar{\lambda}_1$

**EX11** In the given relation

$$\tilde{a}^{kl} \frac{a}{g} + a^{kl} = g^{kl} (g^{ij} a_{ij})$$

the quantities  $a = |a_{k'l'}|$   $g = |g_{k'l'}|$  are determinants with elements  $a_{k'l'}$ ,  $g_{k'l'}$  respectively.

$\tilde{a}^{kl}$  is defined as an element of the inverse of the matrix whose elements are  $a_{kl}$ . This implies the relations

$$(i) \quad \tilde{a}^{11} = \frac{a_{22}}{a} \quad \tilde{a}^{22} = \frac{a_{11}}{a} \quad \tilde{a}^{12} = -\frac{a_{12}}{a} \quad \tilde{a}^{21} = -\frac{a_{21}}{a}$$

The  $a^{kl}$  are defined by the convolution

$$a^{kl} = g^{km} g^{ln} a_{mn}$$

Our equation can therefore be written in the form

$$(ii) \quad \tilde{a}^{kl} \frac{a}{g} = (g^{kl} g^{mn} - g^{km} g^{ln}) a_{mn}$$

where the dummy indices  $i, j$  have been changed into  $m, n$ . The values of the coefficients of  $a_{mn}$  can be determined by inspection. Many of them cancel and we are left with the following correspondences:

$$m, n = 1, 1 \quad k, l = 2, 2 \quad \rightarrow (g^{22} g^{11} - (g^{12})^2) = \frac{1}{g}$$

$$m, n = 2, 2 \quad k, l = 1, 1 \quad \rightarrow \frac{1}{g}$$

$$m = 1 \quad n = 2 \quad k = 1 \quad l = 2 \quad \rightarrow -\frac{1}{g}$$

$$m = 2 \quad n = 1 \quad k = 2 \quad l = 1 \quad \rightarrow -\frac{1}{g}$$

The equation (ii) then reduces to the relations:

$$\tilde{a}^{11} \frac{a}{g} = \frac{1}{g} a_{22} \quad \tilde{a}^{22} \frac{a}{g} = \frac{1}{g} a_{11} \quad \tilde{a}^{12} \frac{a}{g} = -\frac{1}{g} a_{12} \quad \tilde{a}^{21} \frac{a}{g} = -\frac{1}{g} a_{21}$$

which are clearly equivalent with (i). The given identity is thus verified.

**EX12** If  $\varepsilon_{ikl}\sqrt{g}$  is to be a tensor, then the transformation  $\varepsilon_{ikl}\sqrt{g} \rightarrow \bar{\varepsilon}_{pqr}\sqrt{\bar{g}}$  must obey the equation

$$\varepsilon_{ikl}\sqrt{g} = \frac{\partial \bar{u}^p}{\partial u^i} \frac{\partial \bar{u}^q}{\partial u^k} \frac{\partial \bar{u}^r}{\partial u^l} \bar{\varepsilon}_{pqr}\sqrt{\bar{g}}$$

Now, according to the definition of  $\bar{\varepsilon}_{pqr}$ , the following relation holds:

$$\frac{\partial \bar{u}^p}{\partial u^i} \frac{\partial \bar{u}^q}{\partial u^k} \frac{\partial \bar{u}^r}{\partial u^l} \bar{\varepsilon}_{pqr} = \begin{cases} \Phi & \text{for pair permutation of indices } i, k, l \\ -\Phi & \text{for impair } \quad \quad \quad \text{"} \\ 0 & \text{otherwise} \end{cases}$$

where  $\Phi$  is the functional determinant

$$\Phi = \begin{vmatrix} \frac{\partial \bar{u}^1}{\partial u^1} & & \\ & \dots & \\ & & \dots \end{vmatrix}$$

On the other hand, the quantity  $g$  transforms according to the relations

$$g = \bar{g}\Phi^2 \quad ; \quad \sqrt{g} = \frac{\sqrt{\bar{g}}}{\Phi}$$

Hence in the product on the r.h.s. of our equation  $\Phi$  is eliminated and we obtain

$$\varepsilon_{ikl}\sqrt{g} = \begin{cases} \sqrt{\bar{g}} & \text{for pair permutation of indices } i, k, l \\ -\sqrt{\bar{g}} & \text{for impair } \quad \quad \quad \text{"} \\ 0 & \text{otherwise} \end{cases}$$

in accordance with the defining identity of  $\varepsilon_{ikl}$ . This proves the validity of the proposition.

**EX13** The surface  $F$  is related to the vector product of  $\bar{\xi}$  and  $\bar{\eta}$  as follows:

$$F^2 = [\bar{\xi} \bar{\eta}]^2 = \bar{\xi}^2 \bar{\eta}^2 - (\bar{\xi}, \bar{\eta})^2 \quad \text{Laplace}$$

In terms of contravariant components  $\xi^i, \eta^i$  the vectors are

$$\bar{\xi} = \mathbf{e}_i \xi^i, \quad \bar{\eta} = \mathbf{e}_m \eta^m$$

We then have

$$\bar{\xi}^2 = (\mathbf{e}_i \xi^i)(\mathbf{e}_k \xi^k) = g_{ik} \xi^i \xi^k \quad ; \quad \bar{\eta}^2 = g_{mn} \eta^m \eta^n \quad \text{and}$$

$$\bar{\xi}^2 \bar{\eta}^2 = g_{ik} g_{mn} \xi^i \xi^k \eta^m \eta^n$$

$$(\bar{\xi}, \bar{\eta}) = (\mathbf{e}_i, \mathbf{e}_k) \xi^i \eta^k = g_{ik} \xi^i \eta^k$$

$$(\bar{\xi}, \bar{\eta})^2 = g_{ik} g_{mn} \xi^i \xi^m \eta^k \eta^n$$

taking the difference we obtain

$$F^2 = \bar{\xi}^2 \bar{\eta}^2 - (\bar{\xi}, \bar{\eta})^2 = g_{ik} g_{mn} \xi^i \eta^n (\xi^k \eta^m - \xi^m \eta^k)$$

The non zero values of the paranthesis are

$$k=1 \quad m=2 \quad \xi^1 \eta^2 - \xi^2 \eta^1 = \Delta$$

$$k=2 \quad m=1 \quad \xi^2 \eta^1 - \xi^1 \eta^2 = -\Delta$$

and hence

$$F^2 = \Delta (g_{i1} g_{2n} - g_{i2} g_{1n}) \xi^i \eta^n$$

The non zero values of the new paranthesis are

$$i=1 \quad n=2 \quad g_{11} g_{22} - g_{12}^2 = g$$

$$i=2 \quad n=1 \quad g_{21}^2 - g_{22} g_{11} = -g$$

yielding

$$F^2 = \Delta g (\xi^1 \eta^2 - \xi^2 \eta^1) = \Delta^2 g$$

Thus finally

$$F = \sqrt{g} \Delta = \sqrt{g} (\xi^1 \eta^2 - \xi^2 \eta^1) = \sqrt{g} \epsilon_{kl} \xi^k \eta^l \quad \text{q.e.d.}$$

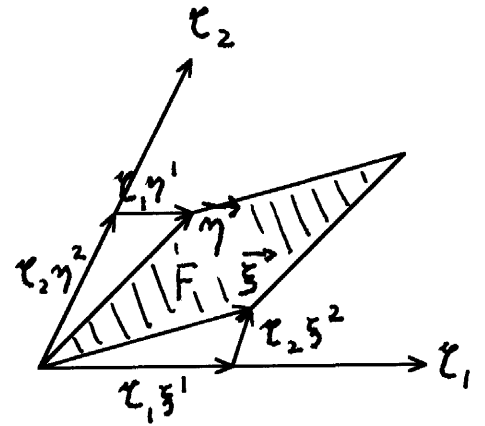

**EX14** We start from the expression for Christoffel symbols of the 1st kind

$$(1) \quad \bar{\Gamma}_{pq,r} = \frac{1}{2} \left( \frac{\partial \bar{g}_{pr}}{\partial \bar{u}^q} - \frac{\partial \bar{g}_{pq}}{\partial \bar{u}^r} + \frac{\partial \bar{g}_{qr}}{\partial \bar{u}^p} \right) .$$

Keeping the derivatives general, we write

$$\bar{g}_{\alpha\beta} = \frac{\partial u^j}{\partial \bar{u}^\alpha} \frac{\partial u^k}{\partial \bar{u}^\beta} g_{jk}$$

$$\frac{\partial \bar{g}_{\alpha\beta}}{\partial \bar{u}^\rho} = \frac{\partial}{\partial \bar{u}^\rho} \left( \frac{\partial u^j}{\partial \bar{u}^\alpha} \frac{\partial u^k}{\partial \bar{u}^\beta} \right) g_{jk} + \frac{\partial u^j}{\partial \bar{u}^\alpha} \frac{\partial u^k}{\partial \bar{u}^\beta} \frac{\partial g_{jk}}{\partial \bar{u}^\rho} = I + II$$

with the following particular values for the indices inside the paranthesis:

$$(2) \quad \text{1st term:} \quad \alpha = p \quad \beta = r \quad \rho = q$$

$$\text{2nd term:} \quad \alpha = p \quad \beta = q \quad \rho = r$$

$$\text{3rd term:} \quad \alpha = q \quad \beta = r \quad \rho = p$$

After substituting these values into the expression for I in its explicit form

$$I = \left( \frac{\partial^2 u^k}{\partial \bar{u}^\rho \partial \bar{u}^\alpha} \frac{\partial u^j}{\partial \bar{u}^\beta} + \frac{\partial^2 u^k}{\partial \bar{u}^\rho \partial \bar{u}^\beta} \frac{\partial u^j}{\partial \bar{u}^\alpha} \right) g_{jk} ,$$

some terms cancel and we find for the contribution of I to the paranthesis in (1) the result

$$(3) \quad 2 \frac{\partial^2 u^k}{\partial \bar{u}^\rho \partial \bar{u}^q} \frac{\partial u^j}{\partial \bar{u}^r} g_{jk}$$

The contribution of II can be evaluated by first introducing the relation

$$(4) \quad \frac{\partial g_{jk}}{\partial \bar{u}^\rho} = \frac{\partial g_{jk}}{\partial u^l} \frac{\partial u^l}{\partial \bar{u}^\rho}$$

where the values of  $\rho$  are given by (3). In order to obtain the final form of the transformation relation, some permutations of dummy indices have to be made on different terms of the paranthesis, in particular: 1st term  $k \leftrightarrow l$ , 3rd term  $j \leftrightarrow l$  followed by  $k \leftrightarrow l$ .

Then the contribution of II to the paranthesis becomes

$$(5) \quad \frac{\partial u^j}{\partial \bar{u}^\rho} \frac{\partial u^k}{\partial \bar{u}^q} \frac{\partial u^l}{\partial \bar{u}^r} \left( \frac{\partial g_{jl}}{\partial u^k} - \frac{\partial g_{jk}}{\partial u^l} + \frac{\partial g_{kl}}{\partial u^j} \right) = 2 \frac{\partial u^j}{\partial \bar{u}^\rho} \frac{\partial u^k}{\partial \bar{u}^q} \frac{\partial u^l}{\partial \bar{u}^r} \Gamma_{jk,l}$$

where the defining relation for  $\Gamma_{jk,l}$  has been used. By adding this result to that given by (3)

we finally obtain from (1) the transformation relation



$$(6) \bar{\Gamma}_{pq,r} = \frac{\partial^2 u^k}{\partial \bar{u}^p \partial \bar{u}^q} \frac{\partial u^j}{\partial \bar{u}^r} g_{jk} + \frac{\partial u^j}{\partial \bar{u}^p} \frac{\partial u^k}{\partial \bar{u}^q} \frac{\partial u^l}{\partial \bar{u}^r} \Gamma_{jk,l}$$

The transformation relation for Christoffel symbols of the second kind is obtained by using the defining relation

$$(7) \bar{\Gamma}_{pq}^s = \bar{g}^{rs} \bar{\Gamma}_{pq,r}$$

By substituting the transformation relation

$$\bar{g}^{rs} = \frac{\partial \bar{u}^r}{\partial u^m} \frac{\partial \bar{u}^s}{\partial u^n} g^{mn}$$

into (7) with  $\bar{\Gamma}_{pq,r}$  given by (6) one first obtains

$$\bar{\Gamma}_{pq}^s = \frac{\partial \bar{u}^r}{\partial u^m} \frac{\partial \bar{u}^s}{\partial u^n} \frac{\partial^2 u^k}{\partial \bar{u}^p \partial \bar{u}^q} \frac{\partial u^j}{\partial \bar{u}^r} g^{mn} g_{jk} + \frac{\partial \bar{u}^r}{\partial u^m} \frac{\partial \bar{u}^s}{\partial u^n} \frac{\partial u^j}{\partial \bar{u}^p} \frac{\partial u^k}{\partial \bar{u}^q} \frac{\partial u^l}{\partial \bar{u}^r} g^{mn} \Gamma_{jk,l}$$

Using the identities

$$\frac{\partial u^j}{\partial \bar{u}^r} \frac{\partial \bar{u}^r}{\partial u^m} = \frac{\partial u^j}{\partial u^m} = \delta_{jm} \quad ; \quad \frac{\partial u^l}{\partial \bar{u}^r} \frac{\partial \bar{u}^r}{\partial u^m} = \delta_{lm}$$

this yields

$$\bar{\Gamma}_{pq}^s = \frac{\partial \bar{u}^s}{\partial u^n} \frac{\partial^2 u^k}{\partial \bar{u}^p \partial \bar{u}^q} g^{jn} g_{jk} + \frac{\partial \bar{u}^s}{\partial u^n} \frac{\partial u^j}{\partial \bar{u}^p} \frac{\partial u^k}{\partial \bar{u}^q} g^{ln} \Gamma_{jk,l}$$

and finally with

$$g^{jn} g_{jk} = \delta_k^n \quad \text{and} \quad g^{ln} \Gamma_{jk,l} = \Gamma_{jk}^n$$

$$(8) \bar{\Gamma}_{pq}^s = \frac{\partial \bar{u}^s}{\partial u^n} \frac{\partial^2 u^k}{\partial \bar{u}^p \partial \bar{u}^q} + \frac{\partial u^j}{\partial \bar{u}^p} \frac{\partial u^k}{\partial \bar{u}^q} \frac{\partial \bar{u}^s}{\partial u^n} \Gamma_{jk}^n$$

**EX15** We want to verify the relation

$$\bar{a}_{j|\bar{i}} = \frac{\partial u^m}{\partial \bar{u}^j} \frac{\partial u^n}{\partial \bar{u}^i} a_{m|n}$$

The proof goes as follows:

$$\begin{aligned} \bar{a}_{j|\bar{i}} &= \bar{a}_{j|i} - \bar{\Gamma}_{j\bar{i}}^k \bar{a}_k & \bar{a}_j &= u^m |_{\bar{j}} a_m \\ & & \bar{a}_k &= u^r |_{\bar{k}} a_r \end{aligned}$$

$$\bar{a}_{j|\bar{i}} = \left( u^m |_{\bar{j}} a_m \right) |_{\bar{i}}$$

$$\bar{\Gamma}_{j\bar{i}}^k = u^m |_{\bar{j}} u^n |_{\bar{i}} \bar{u}^k |_{\bar{p}} \Gamma_{mn}^p + u^m |_{\bar{j}\bar{i}} \bar{u}^k |_{\bar{m}}$$

$$\bar{a}_{j|\bar{i}} = \left( u^m |_{\bar{j}} a_m \right) |_{\bar{i}} - u^m |_{\bar{j}} u^n |_{\bar{i}} \bar{u}^k |_{\bar{p}} \Gamma_{mn}^p u^r |_{\bar{k}} a_r - u^m |_{\bar{j}\bar{i}} \bar{u}^k |_{\bar{m}} u^r |_{\bar{k}} a_r$$

Expliciting the 1st term on the r.h.s. and noticing that  $\bar{u}^k |_{\bar{p}} u^r |_{\bar{k}} = \delta_{\bar{p}}^r$  we obtain

$$\begin{aligned} \bar{a}_{j|\bar{i}} &= u^m |_{\bar{j}} u^n |_{\bar{i}} \left\{ a_{m|n} - \Gamma_{mn}^p a_p \right\} + u^m |_{\bar{j}\bar{i}} a_m - u^m |_{\bar{j}\bar{i}} \bar{u}^k |_{\bar{m}} u^r |_{\bar{k}} a_r \\ &= u^m |_{\bar{j}} u^n |_{\bar{i}} a_{m|n} + a_r \left\{ u^r |_{\bar{j}\bar{i}} - u^m |_{\bar{j}\bar{i}} \bar{u}^k |_{\bar{m}} u^r |_{\bar{k}} \right\} \end{aligned}$$

where we have used the relation  $\left\{ a_{m|n} - \Gamma_{mn}^p a_p \right\} = a_{m|n}$ .

The last term on the r.h.s. of this equation is zero because of  $\bar{u}^k |_{\bar{m}} u^r |_{\bar{k}} = \delta_{\bar{m}}^r$ . The equation therefore reduces to the initial relation which thus has been verified.

**EX16** Specializing of the tensor  $\varepsilon_{\rho\sigma} = \frac{1}{2} \left( v_{\sigma||\rho} + v_{\rho||\sigma} \right)$  with  $v^\rho(q^\mu)$  representing small displacements of a point on an elastic body under the influence of tensions.

1.) cartesian coordinates  $x, y, z$   $v^1 = \Delta x, v^2 = \Delta y, v^3 = \Delta z$

2.) cylinder coordinates

$\rho, \varphi, z$   $v^1 = \Delta\rho, v^2 = \Delta\varphi, v^3 = \Delta z$

3.) spherical coordinates  $r, \vartheta, \varphi$   $v^1 = \Delta r, v^2 = \Delta\vartheta, v^3 = \Delta\varphi$

Explicitly we have

$$\varepsilon_{\rho\sigma} = \frac{1}{2} \left( \frac{\partial v_\sigma}{\partial q^\rho} + \frac{\partial v_\rho}{\partial q^\sigma} - 2\Gamma_{\sigma\rho}^i v_i \right)$$

Christoffel symbols:

1.) cartesian coordinates:  $q^1 = x, q^2 = y, q^3 = z$   $\Gamma_{\sigma\rho}^i = 0$  vanish identically

In the following the Christoffel symbols are determined from geodesics using the Euler-Lagrange equations

2.) cylinder coordinates  $q^1 = \rho, q^2 = \varphi, q^3 = z$ ;  $\dot{s}^2 = \dot{\rho}^2 + \rho^2 \dot{\varphi}^2 + \dot{z}^2$

$$\frac{d}{dt} (2\dot{\rho}) - 2\rho\dot{\varphi}^2 = 0 \rightarrow \ddot{\rho} - \rho\dot{\varphi}^2 = 0$$

$$\frac{d}{dt} (2\rho^2\dot{\varphi}) = 0 \rightarrow \ddot{\varphi} + \frac{2}{\rho}\dot{\rho}\dot{\varphi} = 0$$

$$\frac{d}{dt} (2\dot{z}) = 0 \rightarrow \ddot{z} = 0$$

$$\Gamma_{22}^1 = -\rho; \Gamma_{12}^2 = \Gamma_{21}^2 = \frac{1}{\rho} \text{ the other quantities vanish identically.}$$

3.) spherical coordinates  $q^1 = r, q^2 = \vartheta, q^3 = \varphi$ ;  $\dot{s}^2 = \dot{r}^2 + r^2\dot{\vartheta}^2 + r^2 \sin^2 \vartheta \dot{\varphi}^2$

$$\frac{d}{dt} (2\dot{r}) - (2r\dot{\vartheta}^2 + 2r \sin^2 \vartheta \dot{\varphi}^2) = 0 \rightarrow \ddot{r} - r\dot{\vartheta}^2 - r \sin^2 \vartheta \dot{\varphi}^2 = 0$$

$$\frac{d}{dt} (2r^2\dot{\vartheta}) - (2r^2 \sin \vartheta \cos \vartheta \dot{\varphi}^2) = 0 \rightarrow \ddot{\vartheta} + \frac{2}{r}\dot{r}\dot{\vartheta} - \sin \vartheta \cos \vartheta \dot{\varphi}^2 = 0$$

$$\frac{d}{dt} (2r^2 \sin^2 \vartheta \dot{\varphi}) = 0 \rightarrow \ddot{\varphi} + 2 \cot \vartheta \dot{\vartheta} \dot{\varphi} + \frac{2}{r}\dot{r}\dot{\varphi} = 0$$

$$\Gamma_{22}^1 = -r \quad \Gamma_{33}^1 = -r \sin^2 \vartheta \quad \Gamma_{12}^2 = \Gamma_{21}^2 = \frac{1}{r} \quad \Gamma_{33}^2 = -\sin \vartheta \cos \vartheta \quad \Gamma_{13}^3 = \Gamma_{31}^3 = \frac{1}{r} \quad \Gamma_{23}^3 = \Gamma_{32}^3 = \cot \vartheta$$

the other quantities vanish identically.

Calculation of the tensor components:

1.) Cartesian coordinates.  $v^i = v_i$  and the Christoffel symbols are zero. The result is

$$\varepsilon_{\rho\sigma} = \begin{pmatrix} \frac{\partial v^1}{\partial x} & \frac{1}{2} \left( \frac{\partial v^2}{\partial x} + \frac{\partial v^1}{\partial y} \right) & \frac{1}{2} \left( \frac{\partial v^2}{\partial x} + \frac{\partial v^1}{\partial y} \right) \\ \frac{1}{2} \left( \frac{\partial v^2}{\partial x} + \frac{\partial v^1}{\partial y} \right) & \frac{\partial v^2}{\partial y} & \frac{1}{2} \left( \frac{\partial v^2}{\partial x} + \frac{\partial v^1}{\partial y} \right) \\ \frac{1}{2} \left( \frac{\partial v^2}{\partial x} + \frac{\partial v^1}{\partial y} \right) & \frac{1}{2} \left( \frac{\partial v^2}{\partial x} + \frac{\partial v^1}{\partial y} \right) & \frac{\partial v^3}{\partial z} \end{pmatrix}$$

2.) Cylinder coordinates. Using the Christoffel symbols calculated above, we find

$$\varepsilon_{11} = \frac{\partial v_1}{\partial \rho} \quad \varepsilon_{12} = \varepsilon_{21} = \frac{1}{2} \left( \frac{\partial v_2}{\partial \rho} + \frac{\partial v_1}{\partial \varphi} - \frac{2}{\rho} v_2 \right) \quad \varepsilon_{13} = \varepsilon_{31} = \frac{1}{2} \left( \frac{\partial v_3}{\partial \rho} + \frac{\partial v_1}{\partial z} \right)$$

$$\varepsilon_{22} = \frac{\partial v_2}{\partial \varphi} + \rho v_1 \quad \varepsilon_{23} = \varepsilon_{32} = \frac{1}{2} \left( \frac{\partial v_3}{\partial \varphi} + \frac{\partial v_2}{\partial z} \right) \quad \varepsilon_{33} = \frac{\partial v_3}{\partial z}$$

contravariant components:

$$g_{11} = 1 \quad g_{22} = \rho^2 \quad g_{33} = 1 \quad \text{off diagonal elements vanish}$$

$$v_1 = g_{1i} v^i = v^1 \quad v_2 = g_{2i} v^i = \rho^2 v^2 \quad v_3 = g_{3i} v^i = v^3$$

expliciting the derivatives of these quantities we finally obtain

$$\varepsilon_{\rho\sigma} = \begin{pmatrix} \frac{\partial v^1}{\partial \rho} & \frac{1}{2} \left( \rho^2 \frac{\partial v^2}{\partial \rho} + \frac{\partial v^1}{\partial \varphi} \right) & \frac{1}{2} \left( \frac{\partial v^3}{\partial \rho} + \frac{\partial v^1}{\partial z} \right) \\ \frac{1}{2} \left( \rho^2 \frac{\partial v^2}{\partial \rho} + \frac{\partial v^1}{\partial \varphi} \right) & \frac{1}{2} \left( \rho^2 \frac{\partial v^2}{\partial \varphi} + \rho v^1 \right) & \frac{1}{2} \left( \frac{\partial v^3}{\partial \varphi} + \rho^2 \frac{\partial v^2}{\partial z} \right) \\ \frac{1}{2} \left( \frac{\partial v^3}{\partial \rho} + \frac{\partial v^1}{\partial z} \right) & \frac{1}{2} \left( \frac{\partial v^3}{\partial \varphi} + \rho^2 \frac{\partial v^2}{\partial z} \right) & \frac{\partial v^3}{\partial z} \end{pmatrix}$$

3.) Spherical coordinates. Applying the same procedure as previously we obtain

$$\varepsilon_{11} = \frac{\partial v_1}{\partial r} \quad \varepsilon_{12} = \varepsilon_{21} = \frac{1}{2} \left( \frac{\partial v_2}{\partial r} + \frac{\partial v_1}{\partial \vartheta} - \frac{2}{r} v_2 \right) \quad \varepsilon_{13} = \varepsilon_{31} = \frac{1}{2} \left( \frac{\partial v_3}{\partial r} + \frac{\partial v_1}{\partial \varphi} - \frac{2}{r} v_3 \right)$$

$$\varepsilon_{22} = \frac{\partial v_2}{\partial \vartheta} + r v_1 \quad \varepsilon_{23} = \varepsilon_{32} = \frac{1}{2} \left( \frac{\partial v_3}{\partial \vartheta} + \frac{\partial v_2}{\partial \varphi} - 2 \cot \vartheta v_3 \right)$$

$$\varepsilon_{33} = \frac{\partial v_3}{\partial \varphi} + \sin \vartheta \cos \vartheta v_2 + r \sin^2 \vartheta v_1$$

contravariant components

$$g_{11} = 1 \quad g_{22} = r^2 \quad g_{33} = r^2 \sin^2 \vartheta \quad \text{off diagonal components} = 0$$

$$v_1 = g_{1i} v^i = v^1 \quad v_2 = g_{2i} v^i = r^2 v^2 \quad v_3 = g_{3i} v^i = r^2 \sin^2 \vartheta v^3$$

With the derivatives of these quantities we finally obtain

$$\left( \begin{array}{ccc} \frac{\partial v^1}{\partial r} & \frac{1}{2} \left( r^2 \frac{\partial v^2}{\partial r} + \frac{\partial v^1}{\partial \vartheta} \right) & \frac{1}{2} \left( r^2 \sin^2 \vartheta \frac{\partial v^3}{\partial \vartheta} + \frac{\partial v^1}{\partial \varphi} \right) \\ \frac{1}{2} \left( r^2 \frac{\partial v^2}{\partial r} + \frac{\partial v^1}{\partial \vartheta} \right) & r^2 \frac{\partial v^2}{\partial \vartheta} + r v^1 & \frac{1}{2} \left( r^2 \sin^2 \vartheta \frac{\partial v^3}{\partial \vartheta} + \frac{\partial v^2}{\partial \varphi} \right) \\ \frac{1}{2} \left( r^2 \sin^2 \vartheta \frac{\partial v^3}{\partial r} + \frac{\partial v^1}{\partial \varphi} \right) & \frac{1}{2} \left( r^2 \sin^2 \vartheta \frac{\partial v^3}{\partial \vartheta} + r^2 \frac{\partial v^2}{\partial \varphi} \right) & r^2 \sin^2 \vartheta \frac{\partial v^3}{\partial \varphi} + r^2 \sin \vartheta \cos \vartheta v^2 \\ & & + r \sin^2 \vartheta v^1 \end{array} \right)$$

**EX17** We consider the surfaces a.)  $z = f(x,y)$  ; b.)  $F(x,y,z) = 0$  ; c.) rotation surfaces

a.)  $z = f(x,y)$     $x = u$     $y = v$

$\mathcal{r}$	$\mathcal{r}_u$	$\mathcal{r}_v$	$\mathcal{r}_{uu}$	$\mathcal{r}_{uv}$	$\mathcal{r}_{vv}$	$[\mathcal{r}_u \mathcal{r}_v]$
u	1	0	0	0	0	$-f_u$
v	0	1	0	0	0	$-f_v$
$f(u,v)$	$f_u$	$f_v$	$f_{uu}$	$f_{uv}$	$f_{vv}$	1

$$g_{ik} = \begin{pmatrix} 1 + f_u^2 & f_u f_v \\ f_u f_v & 1 + f_v^2 \end{pmatrix} \quad g = 1 + f_u^2 + f_v^2$$

$$g^{ik} = \begin{pmatrix} \frac{1 + f_v^2}{1 + f_u^2 + f_v^2} & -\frac{f_u f_v}{1 + f_u^2 + f_v^2} \\ -\frac{f_u f_v}{1 + f_u^2 + f_v^2} & \frac{1 + f_u^2}{1 + f_u^2 + f_v^2} \end{pmatrix}$$

$$\langle \mathcal{r}_u \mathcal{r}_v \mathcal{r}_{uu} \rangle = f_{uu}$$

$$\langle \mathcal{r}_u \mathcal{r}_v \mathcal{r}_{uv} \rangle = f_{uv}$$

$$\langle \mathcal{r}_u \mathcal{r}_v \mathcal{r}_{vv} \rangle = f_{vv}$$

$$b_{ik} = \frac{1}{\sqrt{1 + f_u^2 + f_v^2}} \begin{pmatrix} f_{uu} & f_{uv} \\ f_{uv} & f_{vv} \end{pmatrix}$$

$$b_k^k = g^{11}b_{11} + 2g^{12}b_{12} + g^{22}b_{22} = \frac{(1 + f_v^2)f_{uu} - 2f_u f_v f_{uv} + (1 + f_u^2)f_{vv}}{\sqrt{1 + f_u^2 + f_v^2}^3}$$

$$b = \frac{f_{uu}f_{vv} - f_{uv}^2}{1 + f_u^2 + f_v^2} \quad H = \frac{1}{2}b_k^k \quad K = \frac{b}{g}$$

therefore, by replacing  $u,v$  by the initial notation  $x,y$ , we obtain

$$H = \frac{1}{2} \frac{(1 + f_y^2)f_{xx} - 2f_x f_y f_{xy} + (1 + f_x^2)f_{yy}}{\sqrt{1 + f_x^2 + f_y^2}^3}$$

$$K = \frac{f_{xx}f_{yy} - f_{xy}^2}{(1 + f_x^2 + f_y^2)^2}$$

b.)  $F(x,y,z) = 0$     $x = u$ ,  $y = v$ ,  $z = f(u,v)$

$F(u,v,f(u,v)) = 0$  deriving with respect to  $u$  and  $v$  yields

$$\begin{aligned} F_u + F_z f_u &= 0 & f_u &= -\frac{F_u}{F_z} \\ F_v + F_z f_v &= 0 & f_v &= -\frac{F_v}{F_z} \end{aligned}$$

$$\begin{aligned} F_{uu} + 2F_{uz}f_u + F_{zz}f_u^2 + F_z f_{uu} &= 0 \\ F_{uv} + F_{uz}f_v + F_{vz}f_u + F_{zz}f_u f_v + F_z f_{uv} &= 0 \\ F_{vv} + 2F_{vz}f_v + F_{zz}f_v^2 + F_z f_{vv} &= 0 \end{aligned}$$

$$f_{uu} = -\frac{1}{F_z} \left( F_{uu} - \frac{2F_{uz}F_u}{F_z} + \frac{F_{zz}F_u^2}{F_z^2} \right)$$

$$f_{uv} = -\frac{1}{F_z} \left( F_{uv} - \frac{F_{uz}F_v}{F_z} - \frac{F_{vz}F_u}{F_z} + \frac{F_{zz}F_u F_v}{F_z^2} \right)$$

$$f_{vv} = -\frac{1}{F_z} \left( F_{vv} - \frac{2F_{vz}F_v}{F_z} + \frac{F_{zz}F_v^2}{F_z^2} \right)$$

$$g_{ik} = \frac{1}{F_z^2} \begin{pmatrix} F_u^2 + F_z^2 & F_u F_v \\ F_u F_v & F_u^2 + F_z^2 \end{pmatrix}$$

$$g = \frac{F_u^2 + F_v^2 + F_z^2}{F_z^2}$$

$$g^{ik} = \begin{pmatrix} \frac{F_v^2 + F_z^2}{F_u^2 + F_v^2 + F_z^2} & -\frac{F_u F_v}{F_u^2 + F_v^2 + F_z^2} \\ -\frac{F_u F_v}{F_u^2 + F_v^2 + F_z^2} & \frac{F_v^2 + F_z^2}{F_u^2 + F_v^2 + F_z^2} \end{pmatrix}$$

$$b_{ik} = \frac{-1/F_z^2}{\sqrt{F_u^2 + F_v^2 + F_z^2}} \begin{pmatrix} F_{uu}F_z^2 - 2F_{uz}F_u F_z + F_{zz}F_u^2 & F_{uv}F_z^2 - F_{uz}F_v F_z - F_{vz}F_u F_z + F_{zz}F_u F_v \\ F_{uv}F_z^2 - F_{uz}F_v F_z - F_{vz}F_u F_z + F_{zz}F_u F_v & F_{vv}F_z^2 - 2F_{vz}F_v F_z + F_{zz}F_v^2 \end{pmatrix}$$

The determinant of the paranthesis can be transformed as follows

$$|(\dots)| = \frac{1}{F_z} \begin{vmatrix} F_{uu}F_z^2 - 2F_{uz}F_u F_z + F_{zz}F_u^2 & F_{uv}F_z^2 - F_{uz}F_v F_z - F_{vz}F_u F_z + F_{zz}F_u F_v & F_u \\ F_{uv}F_z^2 - F_{uz}F_v F_z - F_{vz}F_u F_z + F_{zz}F_u F_v & F_{vv}F_z^2 - 2F_{vz}F_v F_z + F_{zz}F_v^2 & F_v \\ 0 & 0 & F_z \end{vmatrix}$$

Multiplying the 3rd column successively with  $F_z F_{uz}$ ,  $F_z F_{vz}$ ,  $-F_u F_{zz}$ ,  $-F_v F_{zz}$  and adding it to the first and the 2nd column respectively, we obtain

$$(\dots) = F_Z \begin{vmatrix} F_{uu}F_Z - F_{uz}F_u & F_{uv}F_Z - F_{uz}F_v & F_u \\ F_{uv}F_Z - F_{vz}F_u & F_{vv}F_Z - F_{vz}F_v & F_v \\ F_{uz}F_Z - F_{zz}F_u & F_{vz}F_Z - F_{zz}F_v & F_z \end{vmatrix}$$

This determinant can be cast into the form

$$(\dots) = F_Z^2 \begin{vmatrix} 0 & F_u & F_v & F_z \\ F_u & F_{uu} & F_{uv} & F_{uz} \\ F_v & F_{vu} & F_{vv} & F_{vz} \\ F_z & F_{zu} & F_{zv} & F_{zz} \end{vmatrix}. \quad \text{We thus find}$$

$$b = \frac{1}{F_Z^2} \frac{\begin{vmatrix} 0 & F_u & F_v & F_z \\ F_u & F_{uu} & F_{uv} & F_{uz} \\ F_v & F_{vu} & F_{vv} & F_{vz} \\ F_z & F_{zu} & F_{zv} & F_{zz} \end{vmatrix}}{F_u^2 + F_v^2 + F_z^2}$$

and from the relation for  $b_k^k$  given above in terms of  $f_u, f_{uu}$ , etc

$$b_k^k = -\frac{1}{\sqrt{F_u^2 + F_v^2 + F_z^2}^3} \left\{ \begin{aligned} & (F_v^2 + F_z^2)F_{uu} + (F_u^2 + F_z^2)F_{vv} + (F_u^2 + F_v^2)F_{zz} \\ & -2F_uF_vF_{uv} - 2F_uF_zF_{uz} - 2F_vF_zF_{vz} \end{aligned} \right\}$$

Identifying again  $u, v$  with  $x, y$  we thus obtain the results

$$H = -\frac{1}{2} \frac{1}{\sqrt{F_x^2 + F_y^2 + F_z^2}^3} \left\{ \begin{aligned} & (F_y^2 + F_z^2)F_{xx} + (F_{ux}^2 + F_z^2)F_{yy} + (F_x^2 + F_y^2)F_{zz} \\ & -2F_xF_yF_{xy} - 2F_xF_zF_{xz} - 2F_yF_zF_{yz} \end{aligned} \right\}$$

$$K = \frac{\begin{vmatrix} 0 & F_x & F_y & F_z \\ F_x & F_{xx} & F_{xy} & F_{xz} \\ F_y & F_{yx} & F_{yy} & F_{yz} \\ F_z & F_{zx} & F_{zy} & F_{zz} \end{vmatrix}}{(F_u^2 + F_v^2 + F_z^2)^2}$$

c.) Rotation body. We treat this problem as a special case of b.)

$$r = \psi(z) \quad r^2 = \psi^2(z) = f(z) = x^2 + y^2$$

$$x^2 + y^2 - f(z) = 0 = F(x, y, z) \quad \text{with} \quad r^2 = f(z)$$

$$F_u = 2x \quad F_v = 2y \quad F_z = -f'$$

$$F_{uu} = 2 \quad F_{vv} = 2 \quad F_{zz} = -f'' \quad ' = \frac{d}{dz}$$

$$F_{uv} = 0 \quad F_{uz} = 0 \quad F_{vz} = 0$$

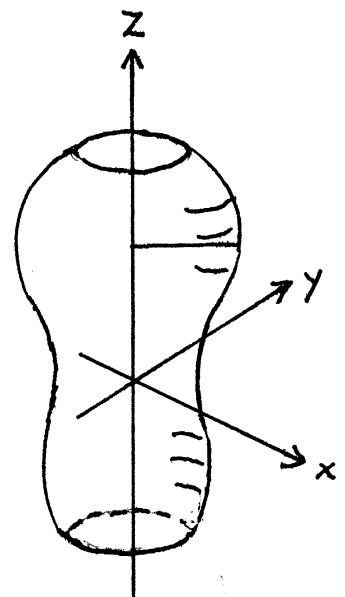



$$g_{ik} = \frac{1}{f'^2} \begin{pmatrix} f'^2 + 4x^2 & 4xy \\ 4xy & f'^2 + 4y^2 \end{pmatrix} \quad g = \frac{4x^2 + 4y^2 + f'^2}{f'^2}$$

$$g^{ik} = \begin{pmatrix} \frac{4y^2 + f'^2}{4x^2 + 4y^2 + f'^2} & -\frac{4xy}{4x^2 + 4y^2 + f'^2} \\ -\frac{4xy}{4x^2 + 4y^2 + f'^2} & \frac{4y^2 + f'^2}{4x^2 + 4y^2 + f'^2} \end{pmatrix}$$

$$b_{ik} = -\frac{1}{f'^2} \frac{1}{\sqrt{4x^2 + 4y^2 + f'^2}} \begin{pmatrix} 2f'^2 - 4x^2 f'' & -4xy f'' \\ -4xy f'' & 2f'^2 - 4y^2 f'' \end{pmatrix}$$

$$b = \frac{4}{f'^2} \frac{f'^2 - 2(x^2 + y^2)f''}{4x^2 + 4y^2 + f'^2}$$

$$H = \frac{1}{2} b^k_k = -\frac{1}{2\sqrt{4x^2 + 4y^2 + f'^2}} \left\{ 2(4y^2 + f'^2) + 2(4x^2 + f'^2) - (4x^2 + 4y^2)f'' \right\}$$

$$K = 4 \frac{f'^2 - 2(x^2 + y^2)f''}{(4x^2 + 4y^2 + f'^2)^2}$$

### Examples

1.) Cylinder  $r^2 = f(z) = \text{const}$   $f' = f'' = 0$

$$K = 0 \quad H = -\frac{1}{2\sqrt{4x^2 + 4y^2}^3} (8x^2 + 8y^2) = -\frac{8r^2}{16r^3} = -\frac{1}{2r} \quad \text{as it should be}$$

2.) Sphere  $r^2 = f(z) = r^2 - z^2$   $f' = -2z$   $f'' = -2$

$$H = -\frac{1}{2\sqrt{4x^2 + 4y^2 + 4z^2}^3} \left\{ 2(4y^2 + 4z^2) + 2(4x^2 + 4z^2) + 2(4x^2 + 4y^2) \right\} = -\frac{1}{r}$$

$$K = 4 \frac{4z^2 + 4(x^2 + y^2)}{(4x^2 + 4y^2 + 4z^2)^2} = \frac{1}{r^2}$$

as it should be.

## EX18 Special parameter lines

## 1.) Geodesic lines

From the relation established in EX6

$$\dot{s}^2 = (R + r \cos v)^2 \dot{u}^2 + r^2 \dot{v}^2$$

we deduce the following Euler - Lagrange equations with  $t$  replaced by  $s$  and  $' = \frac{d}{ds}$  :

$$(1) \quad r^2 v'' + 2r(R + r \cos v) \sin v u' = 0$$

$$(2) \quad (R + r \cos v) u'' - 2r \sin v u' v' = 0 ;$$

by combining these two equations we further have

$$(3) \quad 2r^2 v' v'' + (R + r \cos v)^2 u' u'' = 0$$

In order to obtain the parameter lines we set successively  $u = \text{const}$  and  $v = \text{const}$

a.) with  $u = \text{const}$ ,  $u' = 0$  eq.(1) yields  $v'' = 0 \rightarrow v = as + b$

where the constants are determined from  $s = vr$   $v = \frac{s}{r} \rightarrow a = \frac{1}{r}$   $b = 0$

b.) with  $v = \text{const}$   $v' = v'' = 0$  eq (2) yields  $(R + r \cos v)^2 u' u'' = 0$  or integrated over  $s$  :

$$(R + r \cos v)^2 u'^2 = A \quad \text{and} \quad u = \frac{A}{R + r \cos v} s + B . \quad \text{The constants are } A = 1, B = 0 \text{ since}$$

$s$  obeys the relation  $s = (R + r \cos v) u$ .

We thus conclude that  $u = \text{const}$  and  $v = \text{const}$  are the required parameter lines

## Curvature

We start from the equation

$$b - \lambda(g_{22}b_{11} + g_{11}b_{22}) + \lambda^2 g$$

and use the following quantities calculated in EX6 :

$$(g_{ik}) = \begin{pmatrix} (R + r \cos v)^2 & 0 \\ 0 & r^2 \end{pmatrix} \quad (b_{ik}) = \begin{pmatrix} -(R + r \cos v) \cos v & 0 \\ 0 & -r \end{pmatrix}$$

$$g = r^2 (R + r \cos v)^2 \quad b = r(R + r \cos v) \cos v$$

The quadratic equation now takes the form

$$\lambda^2 r(R + r \cos v) + \lambda(2r \cos v + R) + \cos v = 0$$

Solving this equation we obtain

$$\lambda_{1,2} = \frac{-R - 2r \cos v \pm R}{2r(R + r \cos v)}$$

The curvature radii thus obey the relations

$$\lambda_1 = \frac{1}{R_1} = -\frac{\cos v}{R + r \cos v} \quad ; \quad \lambda_2 = -\frac{1}{r}$$

yielding for the curvatures the results

$$H = \frac{1}{2} \left( \frac{1}{R_1} + \frac{1}{R_2} \right) = -\frac{1}{2} \frac{R}{r(R + r \cos v)}$$

$$K = \frac{1}{R_1} \frac{1}{R_2} = \frac{\cos v}{r(R + r \cos v)}$$

## 2.) Curvature lines

These lines are calculated from the defining equation

$$\begin{vmatrix} -(R + r \cos v) \cos v & (R + r \cos v)^2 & dv^2 \\ 0 & 0 & -dudv \\ -r & r^2 & du^2 \end{vmatrix} = 0$$

Explicitly the determinant reduces to a very simple value and one finally obtains

$du \, dv = 0$ . Therefore with  $du = 0$  or  $dv = 0$  the curvature lines are just the parameter lines

$u = \text{const}$  and  $v = \text{const}$ .

## 3.) Asymptote lines

These are defined by the relation

$$b_{11} du^2 + b_{22} dv^2 = 0$$

With the values of  $b_{11}$   $b_{22}$  calculated in EX6 we thus obtain

$$(R + r \cos v) \cos v du^2 + r dv^2 = 0$$

yielding the solution

$$\frac{du}{dv} = \pm \sqrt{\frac{-r}{(R + r \cos v) \cos v}} \quad \text{and hence}$$

$$u = \pm \int \sqrt{\frac{-r}{(R + r \cos v) \cos v}} dv$$

This expression represents a real quantity only in the region  $\frac{\pi}{2} < v < \frac{3\pi}{2}$  i.e. in the inner part of

the torus where with  $b < 0$  the curvature is hyperbolic. We therefore write the integral in the form

$$u = \pm \int_{\pi/2}^v \sqrt{\frac{-r}{(R+r \cos \eta) \cos \eta}} d\eta + u_0$$

with the maximum value of  $v$  equal  $\frac{3\pi}{2}$ . Furthermore we choose for  $u_0$  the value which makes

$u(\pi) = 0$  i.e. the value

$$u_0 = \mp \int_{\pi/2}^{\pi} \sqrt{\frac{-r}{(R+r \cos \eta) \cos \eta}} d\eta$$

Clearly we then have

$$v = \frac{\pi}{2}, \frac{3\pi}{2} \quad u\left(\frac{\pi}{2}\right) = u\left(\frac{3\pi}{2}\right) = u_0; \quad \frac{du}{dv} = \pm \infty$$

$$v = \pi \quad u(\pi) = 0; \quad \frac{du}{dv} = \sqrt{\frac{r}{R-r}}$$

From the curve obtained in this way ( see figure) all the other parameter lines are generated by vertical translation upwards or downwards (where it is assumed that the torus is placed in a vertical position).

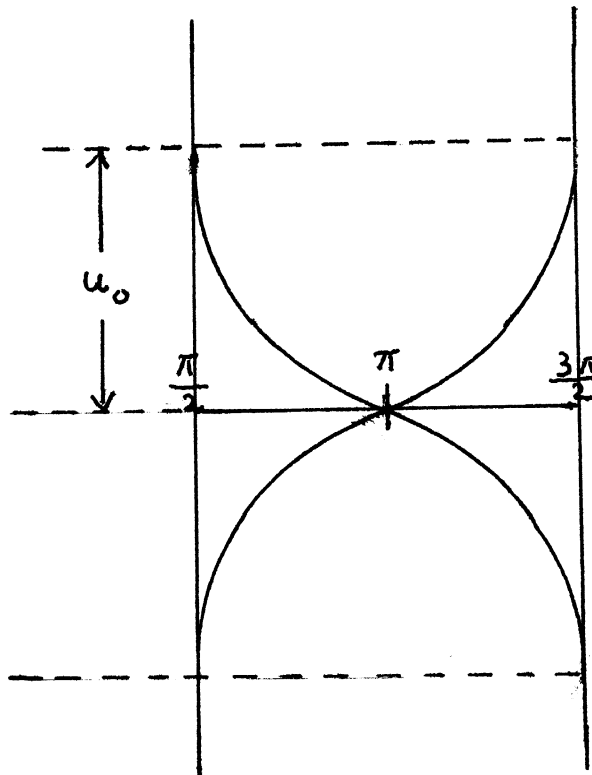

**EX19** Number of components of Riemann's curvature tensor for a partial space  $T_m$  of the  $R_n$  ( $m \leq n$ )

Riemann's curvature tensor:  $R_{iklm}$

We divide the components into the following 5 groups depending of the distribution of their indices:

- |  |          |           |
|--|----------|-----------|
| 1.) all 4 indices are equal                                  | notation | (4)       |
| 2.) 3 indices are equal                                      | “        | (3+1)     |
| 3.) ever 2 indices are equal                                 | “        | (2+2)     |
| 4.) 2 indices are equal, the 2 others are mutually different | “        | (2+1+1)   |
| 5.) all 4 indices are mutually different                     | “        | (1+1+1+1) |

In the following table the second line contains the number of each of the above groups, the third line the number of elements contained in one group and the forth and fifth line the indication of how many of these elements vanish or not vanish respectively.

notation	(4)	(3+1)	(2+2)	(2+1+1)	(1+1+1+1)
number of groups	m	$2 \binom{m}{2}$	$\binom{m}{2}$	$3 \binom{m}{3}$	$\binom{m}{4}$
nb. of elements in 1 group	1	$\frac{4!}{3!} = 4$	$\frac{4!}{2!2!} = 6$	$\frac{4!}{2!} = 12$	$4! = 24$
among them vanish	1	4	2	4	0
among them vanish not	0	0	4	8	24
	1st column	2nd column	3rd column	4th column	5th column

Explanation: the factor 2 in  $2 \binom{m}{2}$  (2nd column) arises because, given two indices, there are 2

possibilities that either one or the other is the one which appears three times. A similar

argument holds for the factor 3 in  $3 \binom{m}{3}$  of the third column.

The numbers in the 3rd line follow from the consideration that, if starting with the 4! permutation possibilities inside a group, permutation of equal indices does not generate new members, so that one must divide by the number of permutation possibilities of equal indices.

The numbers of the 4th line are understood immediately given the fact that all those components of the Riemannian curvature tensor vanish, for which the indices in the 1st and 2nd or the 3rd and 4th position are respectively equal.

The relations for the components of the Riemannian curvature tensor, used in what follows, are

$$(1) R_{iklm} = R_{lmik} = -R_{kilm} = -R_{ikml} \quad \text{hence for instance } R_{11lm} = -R_{11lm} = 0$$

$$(2) R_{iklm} + R_{likm} + R_{klim} = 0$$

The question of independent components can be answered by means of these relations as follows:

3rd column, the 4 non zero elements are, according to relation (1), not mutually essentially different, therefore only one independent component.

4th column: as above: only one independent component

5th column: from relation (1) one obtains 3 essentially different components but according to (2) they are dependent; remain two independent components.

Hence the number of components of the Riemannian curvature tensor are:

1.) total number of components:

$$Z_1 = m \cdot 1 + 2 \binom{m}{2} \cdot 6 + 3 \binom{m}{3} \cdot 12 + \binom{m}{4} \cdot 24 = m^4$$

2.) number of vanishing components:

$$Z_2 = m \cdot 1 + 2 \binom{m}{2} \cdot 4 + \binom{m}{2} \cdot 2 + 3 \binom{m}{3} \cdot 4 = m^2 (2m - 1)$$

3.) number of non vanishing components

$$Z_3 = 4 \binom{m}{2} + 24 \binom{m}{3} + 24 \binom{m}{4} = m^2 (m - 1)^2$$

4.) number of independent components

$$Z_4 = \binom{m}{2} \cdot 1 + 3 \binom{m}{3} \cdot 1 + \binom{m}{4} \cdot 2 = \frac{1}{12} m^2 (m^2 - 1)$$

Remark: one can easily conceive that the above formulae are valid for ~~for~~  $m < 4$  as well.

Although in this case the balance of components yields a different expression (valid only for one given  $m$ ), the numerical result is the same.

Synthesis of the results:

m	total number $m^4$	vanish $m^2(2m-1)$	vanish not $m^2(m-1)^2$	nb. of independent comp. $\frac{1}{12}m^2(m^2-1)$
1	1	1	0	0
2	16	12	4	1
3	81	45	36	6
4	256	112	144	20
5	625	225	400	50
6	1296	396	900	<b>105</b>

**EX20** Prove the following relation valid for a surface in the  $R_3$ :  $K = -\frac{R_{kl}}{g_{kl}}$

Defining relation:  $R_{kl} = g^{im} R_{iklm}$

For a surface in the  $R_3$  we have  $g^{11} = \frac{g_{22}}{g}$   $g^{12} = -\frac{g^{12}}{g}$   $g^{22} = \frac{g_{11}}{g}$

and the non vanishing components of  $R_{iklm}$  are

$$R_{1212} = b \quad R_{2121} = b \quad R_{1221} = -b \quad R_{2112} = -b$$

We thus obtain

$$R_{11} = g^{im} R_{i11m} = g^{22} R_{2112} = -b g^{22} = -b \frac{g_{11}}{g}$$

$$R_{12} = g^{im} R_{i12m} = g^{21} R_{2121} = b g^{21} = -b \frac{g_{12}}{g}$$

$$R_{21} = g^{im} R_{i21m} = g^{12} R_{1212} = b g^{12} = -b \frac{g_{21}}{g}$$

$$R_{22} = g^{im} R_{i22m} = g^{11} R_{1221} = -b g^{11} = -b \frac{g_{22}}{g}$$

$$\text{with } g_{12} = g_{21}$$

and therefore

$$R_{kl} = -b \frac{g_{kl}}{g} = -K g_{kl} \quad \text{with } K = \frac{b}{g}$$

yielding finally

$$K = -\frac{R_{kl}}{g_{kl}} \quad \text{qed}$$

**EX21** Show that  $K = -\frac{R}{2}$

with  $R = g^{kl} R_{kl}$ .

$$R_{kl} = -K g_{kl} \quad \text{therefore} \quad R = -g^{kl} g_{kl} \cdot K = -\delta^l_l K = -2K$$

where  $g^{kl} g_{kl} = \delta^l_l = 2$  has been used.

Thus finally

$$K = -\frac{R}{2} \quad \text{qed}$$