



**HAL**  
open science

## Flat systems, equivalence and trajectory generation

Philippe Martin, Pierre Rouchon, R. M. Murray

► **To cite this version:**

Philippe Martin, Pierre Rouchon, R. M. Murray. Flat systems, equivalence and trajectory generation. 3rd cycle. Castro Urdiales (Espagne), France. 2006, pp.81. cel-00392180

**HAL Id: cel-00392180**

**<https://cel.hal.science/cel-00392180>**

Submitted on 6 Jun 2009

**HAL** is a multi-disciplinary open access archive for the deposit and dissemination of scientific research documents, whether they are published or not. The documents may come from teaching and research institutions in France or abroad, or from public or private research centers.

L'archive ouverte pluridisciplinaire **HAL**, est destinée au dépôt et à la diffusion de documents scientifiques de niveau recherche, publiés ou non, émanant des établissements d'enseignement et de recherche français ou étrangers, des laboratoires publics ou privés.

# Flat systems, equivalence and trajectory generation

Ph. Martin\*      R. M. Murray†      P. Rouchon\*

Technical report, April 2003

## Contents

<b>1</b>	<b>Introduction</b>	<b>3</b>
<b>2</b>	<b>Equivalence and flatness</b>	<b>6</b>
2.1	Control systems as infinite dimensional vector fields . . . . .	6
2.2	Equivalence of systems . . . . .	9
2.3	Differential Flatness . . . . .	12
2.4	Application to motion planning . . . . .	13
2.5	Motion planning with singularities . . . . .	14
<b>3</b>	<b>Feedback design with equivalence</b>	<b>15</b>
3.1	From equivalence to feedback . . . . .	15
3.2	Endogenous feedback . . . . .	18
3.3	Tracking: feedback linearization . . . . .	19
3.4	Tracking: singularities and time scaling . . . . .	20
3.5	Tracking: flatness and backstepping . . . . .	21
3.5.1	Some drawbacks of feedback linearization . . . . .	21
3.5.2	Backstepping . . . . .	23
3.5.3	Blending equivalence with backstepping . . . . .	23
3.5.4	Backstepping and time-scaling . . . . .	27
3.5.5	Conclusion . . . . .	27
<b>4</b>	<b>Checking flatness: an overview</b>	<b>28</b>
4.1	The general problem . . . . .	28
4.2	Known results . . . . .	29
4.2.1	Systems linearizable by static feedback. . . . .	29
4.2.2	Single-input systems. . . . .	29

---

\*Centre Automatique et Systèmes, École des Mines de Paris, 35 rue Saint-Honoré, 77305 Fontainebleau, FRANCE. [martin,rouchon]@cas.ensmp.fr.

†Division of Engineering and Applied Science, California Institute of Technology, Pasadena, CA 91125, USA. murray@cds.caltech.edu.

4.2.3	Affine systems of codimension 1. . . . .	29
4.2.4	Affine systems with 2 inputs and 4 states. . . . .	29
4.2.5	Driftless systems. . . . .	29
4.2.6	Mechanical systems. . . . .	30
4.2.7	A necessary condition. . . . .	30
<b>5</b>	<b>State constraints and optimal control</b>	<b>31</b>
5.1	Optimal control . . . . .	31
5.2	State constraints and predictive control . . . . .	32
<b>6</b>	<b>Symmetries</b>	<b>33</b>
6.1	Symmetry preserving flat output . . . . .	33
6.2	Flat outputs as potentials and gauge degree of freedom . . . . .	34
<b>7</b>	<b>Catalogue of finite dimensional flat systems.</b>	<b>35</b>
7.1	Holonomic mechanical systems . . . . .	35
7.1.1	Fully actuated holonomic systems . . . . .	35
7.1.2	Linearized cart inverted pendulum . . . . .	36
7.1.3	The double inverted pendulum . . . . .	38
7.1.4	Planar rigid body with forces . . . . .	38
7.1.5	The rocket . . . . .	39
7.1.6	PVTOL aircraft . . . . .	40
7.1.7	$2k\pi$ the juggling robot [47] . . . . .	40
7.1.8	Towed cable systems [70, 59] . . . . .	41
7.1.9	Gantry crane [22, 51, 49] . . . . .	43
7.1.10	Conventional aircraft . . . . .	43
7.1.11	Satellite with two controls . . . . .	43
7.2	Nonholonomic mechanical systems . . . . .	44
7.2.1	The car . . . . .	44
7.2.2	Car with $n$ -trailers [22] . . . . .	45
7.2.3	The general one-trailer system [98] . . . . .	47
7.2.4	The rolling penny . . . . .	48
7.2.5	Kinematics generated by <i>two</i> nonholonomic constraints . . . . .	48
7.3	Electromechanical systems . . . . .	49
7.3.1	DC-to-DC converter . . . . .	49
7.3.2	Magnetic bearings . . . . .	49
7.3.3	Induction motor . . . . .	49
7.4	Chemical systems . . . . .	49
7.4.1	CSTRs . . . . .	49
7.4.2	heating system . . . . .	50
7.4.3	Polymerization reactor . . . . .	51
<b>8</b>	<b>Infinite dimension “flat” systems</b>	<b>51</b>
8.1	Delay systems . . . . .	51
8.2	Distributed parameters systems . . . . .	54

<b>9</b>	<b>A catalog of infinite dimensional “flat systems”</b>	<b>57</b>
9.1	Chemical réactor with a recycle loop . . . . .	57
9.2	The nonholonomic snake . . . . .	58
9.3	Nonlinear heavy chain systems . . . . .	60
9.4	Burger equation without diffusion [80] . . . . .	61
9.5	Mixing processes . . . . .	62
9.6	Flexible beam (Euler-Bernoulli) [2, 28] . . . . .	64
9.7	Horizontal translation of the circular tank: the tumbler [83] . . . . .	67
9.8	Tubular reactor (convection/diffusion) . . . . .	68
9.9	The indian rope . . . . .	69
9.10	Drilling system . . . . .	70
9.11	Water tank . . . . .	70
9.12	The electric line . . . . .	71
9.13	Isentropic gas dynamics in one dimension . . . . .	73

## 1 Introduction

Control systems are ubiquitous in modern technology. The use of feedback control can be found in systems ranging from simple thermostats that regulate the temperature of a room, to digital engine controllers that govern the operation of engines in cars, ships, and planes, to flight control systems for high performance aircraft. The rapid advances in sensing, computation, and actuation technologies is continuing to drive this trend and the role of control theory in advanced (and even not so advanced) systems is increasing.

A typical use of control theory in many modern systems is to invert the system dynamics to compute the inputs required to perform a specific task. This inversion may involve finding appropriate inputs to steer a control system from one state to another or may involve finding inputs to follow a desired trajectory for some or all of the state variables of the system. In general, the solution to a given control problem will not be unique, if it exists at all, and so one must trade off the performance of the system for the stability and actuation effort. Often this tradeoff is described as a cost function balancing the desired performance objectives with stability and effort, resulting in an optimal control problem.

This inverse dynamics problem assumes that the dynamics for the system are known and fixed. In practice, uncertainty and noise are always present in systems and must be accounted for in order to achieve acceptable performance of this system. Feedback control formulations allow the system to respond to errors and changing operating conditions in real-time and can substantially affect the operability of the system by stabilizing the system and extending its capabilities. Again, one may formulate the feedback regulation problems as an optimization problem to allow tradeoffs between stability, performance, and actuator effort.

The basic paradigm used in most, if not all, control techniques is to exploit the mathematical structure of the system to obtain solutions to the inverse

dynamics and feedback regulation problems. The most common structure to exploit is linear structure, where one approximates the given system by its linearization and then uses properties of linear control systems combined with appropriate cost function to give closed form (or at least numerically computable) solutions. By using different linearizations around different operating points, it is even possible to obtain good results when the system is nonlinear by “scheduling” the gains depending on the operating point.

As the systems that we seek to control become more complex, the use of linear structure alone is often not sufficient to solve the control problems that are arising in applications. This is especially true of the inverse dynamics problems, where the desired task may span multiple operating regions and hence the use of a single linear system is inappropriate.

In order to solve these harder problems, control theorists look for different types of structure to exploit in addition to simple linear structure. In this paper we concentrate on a specific class of systems, called “(differentially) flat systems”, for which the structure of the trajectories of the (nonlinear) dynamics can be completely characterized. Flat systems are a generalization of linear systems (in the sense that all linear, controllable systems are flat), but the techniques used for controlling flat systems are much different than many of the existing techniques for linear systems. As we shall see, flatness is particularly well tuned for allowing one to solve the inverse dynamics problems and one builds off of that fundamental solution in using the structure of flatness to solve more general control problems.

Flatness was first defined by Fliess et al. [19, 22] using the formalism of differential algebra, see also [53] for a somewhat different approach. In differential algebra, a system is viewed as a differential field generated by a set of variables (states and inputs). The system is said to be flat if one can find a set of variables, called the flat outputs, such that the system is (non-differentially) algebraic over the differential field generated by the set of flat outputs. Roughly speaking, a system is flat if we can find a set of outputs (equal in number to the number of inputs) such that all states and inputs can be determined from these outputs without integration. More precisely, if the system has states  $x \in \mathbb{R}^n$ , and inputs  $u \in \mathbb{R}^m$  then the system is flat if we can find outputs  $y \in \mathbb{R}^m$  of the form

$$y = h(x, u, \dot{u}, \dots, u^{(r)})$$

such that

$$\begin{aligned} x &= \varphi(y, \dot{y}, \dots, y^{(q)}) \\ u &= \alpha(y, \dot{y}, \dots, y^{(q)}). \end{aligned}$$

More recently, flatness has been defined in a more geometric context, where tools for nonlinear control are more commonly available. One approach is to use exterior differential systems and regard a nonlinear control system as a Pfaffian system on an appropriate space [110]. In this context, flatness can be described in terms of the notion of absolute equivalence defined by E. Cartan [8, 9, 104].

In this paper we adopt a somewhat different geometric point of view, relying on a Lie-Bäcklund framework as the underlying mathematical structure. This point of view was originally described in [20, 23, 24] and is related to the work of Pomet et al. [87, 85] on “infinitesimal Brunovsky forms” (in the context of feedback linearization). It offers a compact framework in which to describe basic results and is also closely related to the basic techniques that are used to compute the functions that are required to characterize the solutions of flat systems (the so-called flat outputs).

Applications of flatness to problems of engineering interest have grown steadily in recent years. It is important to point out that many classes of systems commonly used in nonlinear control theory are flat. As already noted, all controllable linear systems can be shown to be flat. Indeed, any system that can be transformed into a linear system by changes of coordinates, static feedback transformations (change of coordinates plus nonlinear change of inputs), or dynamic feedback transformations is also flat. Nonlinear control systems in “pure feedback form”, which have gained popularity due to the applicability of backstepping [41] to such systems, are also flat. Thus, many of the systems for which strong nonlinear control techniques are available are in fact flat systems, leading one to question how the structure of flatness plays a role in control of such systems.

One common misconception is that flatness amounts to dynamic feedback linearization. It is true that any flat system can be feedback linearized using dynamic feedback (up to some regularity conditions that are generically satisfied). However, flatness is a property of a system and does not imply that one intends to then transform the system, via a dynamic feedback and appropriate changes of coordinates, to a single linear system. Indeed, the power of flatness is precisely that it does not convert nonlinear systems into linear ones. When a system is flat it is an indication that the nonlinear structure of the system is well characterized and one can exploit that structure in designing control algorithms for motion planning, trajectory generation, and stabilization. Dynamic feedback linearization is one such technique, although it is often a poor choice if the dynamics of the system are substantially different in different operating regimes.

Another advantage of studying flatness over dynamic feedback linearization is that flatness is a *geometric* property of a system, independent of coordinate choice. Typically when one speaks of linear systems in a state space context, this does not make sense geometrically since the system is linear only in certain choices of coordinate representations. In particular, it is difficult to discuss the notion of a linear state space system on a manifold since the very definition of linearity requires an underlying linear space. In this way, flatness can be considered the proper geometric notion of linearity, even though the system may be quite nonlinear in almost any natural representation.

Finally, the notion of flatness can be extended to distributed parameters systems with boundary control and is useful even for controlling linear systems, whereas feedback linearization is yet to be defined in that context.

## 2 Equivalence and flatness

### 2.1 Control systems as infinite dimensional vector fields

A system of differential equations

$$\dot{x} = f(x), \quad x \in X \subset \mathbb{R}^n \quad (1)$$

is by definition a pair  $(X, f)$ , where  $X$  is an open set of  $\mathbb{R}^n$  and  $f$  is a smooth vector field on  $X$ . A solution, or *trajectory*, of (1) is a mapping  $t \mapsto x(t)$  such that

$$\dot{x}(t) = f(x(t)) \quad \forall t \geq 0.$$

Notice that if  $x \mapsto h(x)$  is a smooth function on  $X$  and  $t \mapsto x(t)$  is a trajectory of (1), then

$$\frac{d}{dt}h(x(t)) = \frac{\partial h}{\partial x}(x(t)) \cdot \dot{x}(t) = \frac{\partial h}{\partial x}(x(t)) \cdot f(x(t)) \quad \forall t \geq 0.$$

For that reason the *total derivative*, i.e., the mapping

$$x \mapsto \frac{\partial h}{\partial x}(x) \cdot f(x)$$

is somewhat abusively called the “time-derivative” of  $h$  and denoted by  $\dot{h}$ .

We would like to have a similar description, i.e., a “space” and a vector field on this space, for a control system

$$\dot{x} = f(x, u), \quad (2)$$

where  $f$  is smooth on an open subset  $X \times U \subset \mathbb{R}^n \times \mathbb{R}^m$ . Here  $f$  is no longer a vector field on  $X$ , but rather an *infinite collection* of vector fields on  $X$  parameterized by  $u$ : for all  $u \in U$ , the mapping

$$x \mapsto f_u(x) = f(x, u)$$

is a vector field on  $X$ . Such a description is not well-adapted when considering dynamic feedback.

It is nevertheless possible to associate to (2) a vector field with the “same” solutions using the following remarks: given a smooth solution of (2), i.e., a mapping  $t \mapsto (x(t), u(t))$  with values in  $X \times U$  such that

$$\dot{x}(t) = f(x(t), u(t)) \quad \forall t \geq 0,$$

we can consider the *infinite* mapping

$$t \mapsto \xi(t) = (x(t), u(t), \dot{u}(t), \dots)$$

taking values in  $X \times U \times \mathbb{R}_m^\infty$ , where  $\mathbb{R}_m^\infty = \mathbb{R}^m \times \mathbb{R}^m \times \dots$  denotes the product of an infinite (countable) number of copies of  $\mathbb{R}^m$ . A typical point of  $\mathbb{R}_m^\infty$  is thus of the form  $(u^1, u^2, \dots)$  with  $u^i \in \mathbb{R}^m$ . This mapping satisfies

$$\dot{\xi}(t) = (f(x(t), u(t)), \dot{u}(t), \ddot{u}(t), \dots) \quad \forall t \geq 0,$$

hence it can be thought of as a trajectory of the *infinite* vector field

$$(x, u, u^1, \dots) \mapsto F(x, u, u^1, \dots) = (f(x, u), u^1, u^2, \dots)$$

on  $X \times U \times \mathbb{R}_m^\infty$ . Conversely, any mapping

$$t \mapsto \xi(t) = (x(t), u(t), u^1(t), \dots)$$

that is a trajectory of this infinite vector field necessarily takes the form  $(x(t), u(t), \dot{u}(t), \dots)$  with  $\dot{x}(t) = f(x(t), u(t))$ , hence corresponds to a solution of (2). Thus  $F$  is truly a vector field and no longer a parameterized family of vector fields.

Using this construction, the control system (2) can be seen as the data of the “space”  $X \times U \times \mathbb{R}_m^\infty$  together with the “smooth” vector field  $F$  on this space. Notice that, as in the uncontrolled case, we can define the “time-derivative” of a smooth function  $(x, u, u^1, \dots) \mapsto h(x, u, u^1, \dots, u^k)$  depending on a *finite* number of variables by

$$\begin{aligned} \dot{h}(x, u, u^1, \dots, u^{k+1}) &:= Dh \cdot F \\ &= \frac{\partial h}{\partial x} \cdot f(x, u) + \frac{\partial h}{\partial u} \cdot u^1 + \frac{\partial h}{\partial u^1} \cdot u^2 + \dots \end{aligned}$$

The above sum is *finite* because  $h$  depends on finitely many variables.

**Remark 1.** *To be rigorous we must say something of the underlying topology and differentiable structure of  $\mathbb{R}_m^\infty$  to be able to speak of smooth objects [113]. This topology is the Fréchet topology, which makes things look as if we were working on the product of  $k$  copies of  $\mathbb{R}^m$  for a “large enough”  $k$ . For our purpose it is enough to know that a basis of the open sets of this topology consists of infinite products  $U_0 \times U_1 \times \dots$  of open sets of  $\mathbb{R}^m$ , and that a function is smooth if it depends on a finite but arbitrary number of variables and is smooth in the usual sense. In the same way a mapping  $\Phi : \mathbb{R}_m^\infty \rightarrow \mathbb{R}_n^\infty$  is smooth if all of its components are smooth functions.*

$\mathbb{R}_m^\infty$  equipped with the Fréchet topology has very weak properties: useful theorems such as the implicit function theorem, the Frobenius theorem, and the straightening out theorem no longer hold true. This is only because  $\mathbb{R}_m^\infty$  is a very big space: indeed the Fréchet topology on the product of  $k$  copies of  $\mathbb{R}^m$  for any finite  $k$  coincides with the usual Euclidian topology.

We can also define manifolds modeled on  $\mathbb{R}_m^\infty$  using the standard machinery. The reader not interested in these technicalities can safely ignore the details and won’t lose much by replacing “manifold modeled on  $\mathbb{R}_m^\infty$ ” by “open set of  $\mathbb{R}_m^\infty$ ”.

We are now in position to give a formal definition of a system:

**Definition 1.** *A system is a pair  $(\mathfrak{M}, F)$  where  $\mathfrak{M}$  is a smooth manifold, possibly of infinite dimension, and  $F$  is a smooth vector field on  $\mathfrak{M}$ .*

Locally, a control system looks like an open subset of  $\mathbb{R}^\alpha$  ( $\alpha$  not necessarily finite) with coordinates  $(\xi_1, \dots, \xi_\alpha)$  together with the vector field

$$\xi \mapsto F(\xi) = (F_1(\xi), \dots, F_\alpha(\xi))$$



where all the components  $F_i$  depend only on a finite number of coordinates. A *trajectory* of the system is a mapping  $t \mapsto \xi(t)$  such that  $\dot{\xi}(t) = F(\xi(t))$ .

We saw in the beginning of this section how a “traditional” control system fits into our definition. There is nevertheless an important difference: we lose the notion of *state dimension*. Indeed

$$\dot{x} = f(x, u), \quad (x, u) \in X \times U \subset \mathbb{R}^n \times \mathbb{R}^m \quad (3)$$

and

$$\dot{x} = f(x, u), \quad \dot{u} = v \quad (4)$$

now have the same description  $(X \times U \times \mathbb{R}_m^\infty, F)$ , with

$$F(x, u, u^1, \dots) = (f(x, u), u^1, u^2, \dots),$$

in our formalism:  $t \mapsto (x(t), u(t))$  is a trajectory of (3) if and only if  $t \mapsto (x(t), u(t), \dot{u}(t))$  is a trajectory of (4). This situation is not surprising since the state dimension is of course not preserved by dynamic feedback. On the other hand we will see there is still a notion of *input dimension*.

**Example 1 (The trivial system).** *The trivial system  $(\mathbb{R}_m^\infty, F_m)$ , with coordinates  $(y, y^1, y^2, \dots)$  and vector field*

$$F_m(y, y^1, y^2, \dots) = (y^1, y^2, y^3, \dots)$$

*describes any “traditional” system made of  $m$  chains of integrators of arbitrary lengths, and in particular the direct transfer  $y = u$ .*

In practice we often identify the “system”  $F(x, \bar{u}) := (f(x, u), u^1, u^2, \dots)$  with the “dynamics”  $\dot{x} = f(x, u)$  which defines it. Our main motivation for introducing a new formalism is that it will turn out to be a natural framework for the notions of equivalence and flatness we want to define.

**Remark 2.** *It is easy to see that the manifold  $\mathfrak{M}$  is finite-dimensional only when there is no input, i.e., to describe a determined system of differential equations one needs as many equations as variables. In the presence of inputs, the system becomes underdetermined, there are more variables than equations, which accounts for the infinite dimension.*

**Remark 3.** *Our definition of a system is adapted from the notion of diffiety introduced in [113] to deal with systems of (partial) differential equations. By definition a diffiety is a pair  $(\mathfrak{M}, CT\mathfrak{M})$  where  $\mathfrak{M}$  is smooth manifold, possibly of infinite dimension, and  $CT\mathfrak{M}$  is an involutive finite-dimensional distribution on  $\mathfrak{M}$ , i.e., the Lie bracket of any two vector fields of  $CT\mathfrak{M}$  is itself in  $CT\mathfrak{M}$ . The dimension of  $CT\mathfrak{M}$  is equal to the number of independent variables.*

*As we are only working with systems with lumped parameters, hence governed by ordinary differential equations, we consider diffieties with one dimensional distributions. For our purpose we have also chosen to single out a particular vector field rather than work with the distribution it spans.*

## 2.2 Equivalence of systems

In this section we define an equivalence relation formalizing the idea that two systems are “equivalent” if there is an invertible transformation exchanging their trajectories. As we will see later, the relevance of this rather natural equivalence notion lies in the fact that it admits an interpretation in terms of dynamic feedback.

Consider two systems  $(\mathfrak{M}, F)$  and  $(\mathfrak{N}, G)$  and a smooth mapping  $\Psi : \mathfrak{M} \rightarrow \mathfrak{N}$  (remember that by definition every component of a smooth mapping depends only on finitely many coordinates). If  $t \mapsto \xi(t)$  is a trajectory of  $(\mathfrak{M}, F)$ , i.e.,

$$\forall \xi, \quad \dot{\xi}(t) = F(\xi(t)),$$

the composed mapping  $t \mapsto \zeta(t) = \Psi(\xi(t))$  satisfies the chain rule

$$\dot{\zeta}(t) = \frac{\partial \Psi}{\partial \xi}(\xi(t)) \cdot \dot{\xi}(t) = \frac{\partial \Psi}{\partial \xi}(\xi(t)) \cdot F(\xi(t)).$$

The above expressions involve only finite sums even if the matrices and vectors have infinite sizes: indeed a row of  $\frac{\partial \Psi}{\partial \xi}$  contains only a finite number of non zero terms because a component of  $\Psi$  depends only on finitely many coordinates. Now, if the vector fields  $F$  and  $G$  are  $\Psi$ -related, i.e.,

$$\forall \xi, \quad G(\Psi(\xi)) = \frac{\partial \Psi}{\partial \xi}(\xi) \cdot F(\xi)$$

then

$$\dot{\zeta}(t) = G(\Psi(\xi(t))) = G(\zeta(t)),$$

which means that  $t \mapsto \zeta(t) = \Psi(\xi(t))$  is a trajectory of  $(\mathfrak{N}, G)$ . If moreover  $\Psi$  has a smooth inverse  $\Phi$  then obviously  $F, G$  are also  $\Phi$ -related, and there is a one-to-one correspondence between the trajectories of the two systems. We call such an invertible  $\Psi$  relating  $F$  and  $G$  an *endogenous transformation*.

**Definition 2.** *Two systems  $(\mathfrak{M}, F)$  and  $(\mathfrak{N}, G)$  are equivalent at  $(p, q) \in \mathfrak{M} \times \mathfrak{N}$  if there exists an endogenous transformation from a neighborhood of  $p$  to a neighborhood of  $q$ .  $(\mathfrak{M}, F)$  and  $(\mathfrak{N}, G)$  are equivalent if they are equivalent at every pair of points  $(p, q)$  of a dense open subset of  $\mathfrak{M} \times \mathfrak{N}$ .*

Notice that when  $\mathfrak{M}$  and  $\mathfrak{N}$  have the same *finite* dimension, the systems are necessarily equivalent by the straightening out theorem. This is no longer true in infinite dimensions.

Consider the two systems  $(X \times U \times \mathbb{R}_m^\infty, F)$  and  $(Y \times V \times \mathbb{R}_s^\infty, G)$  describing the dynamics

$$\dot{x} = f(x, u), \quad (x, u) \in X \times U \subset \mathbb{R}^n \times \mathbb{R}^m \tag{5}$$

$$\dot{y} = g(y, v), \quad (y, v) \in Y \times V \subset \mathbb{R}^r \times \mathbb{R}^s. \tag{6}$$

The vector fields  $F, G$  are defined by

$$\begin{aligned} F(x, u, u^1, \dots) &= (f(x, u), u^1, u^2, \dots) \\ G(y, v, v^1, \dots) &= (g(y, v), v^1, v^2, \dots). \end{aligned}$$

If the systems are equivalent, the endogenous transformation  $\Psi$  takes the form

$$\Psi(x, u, u^1, \dots) = (\psi(x, \bar{u}), \beta(x, \bar{u}), \dot{\beta}(x, \bar{u}), \dots).$$

Here we have used the short-hand notation  $\bar{u} = (u, u^1, \dots, u^k)$ , where  $k$  is some finite but otherwise arbitrary integer. Hence  $\Psi$  is completely specified by the mappings  $\psi$  and  $\beta$ , i.e, by the expression of  $y, v$  in terms of  $x, \bar{u}$ . Similarly, the inverse  $\Phi$  of  $\Psi$  takes the form

$$\Phi(y, v, v^1, \dots) = (\varphi(y, \bar{v}), \alpha(y, \bar{v}), \dot{\alpha}(y, \bar{v}), \dots).$$

As  $\Psi$  and  $\Phi$  are inverse mappings we have

$$\begin{aligned} \psi(\varphi(y, \bar{v}), \bar{\alpha}(y, \bar{v})) &= y & \text{and} & & \varphi(\psi(x, \bar{u}), \bar{\beta}(x, \bar{u})) &= x \\ \beta(\varphi(y, \bar{v}), \bar{\alpha}(y, \bar{v})) &= v & & & \alpha(\psi(x, \bar{u}), \bar{\beta}(x, \bar{u})) &= u. \end{aligned}$$

Moreover  $F$  and  $G$   $\Psi$ -related implies

$$f(\varphi(y, \bar{v}), \alpha(y, \bar{v})) = D\varphi(y, \bar{v}) \cdot \bar{g}(y, \bar{v})$$

where  $\bar{g}$  stands for  $(g, v^1, \dots, v^k)$ , i.e., a truncation of  $G$  for some large enough  $k$ . Conversely,

$$g(\psi(x, \bar{u}), \beta(y, \bar{u})) = D\psi(x, \bar{u}) \cdot \bar{f}(y, \bar{u}).$$

In other words, whenever  $t \mapsto (x(t), u(t))$  is a trajectory of (5)

$$t \mapsto (y(t), v(t)) = (\varphi(x(t), \bar{u}(t)), \alpha(x(t), \bar{u}(t)))$$

is a trajectory of (6), and vice versa.

**Example 2 (The PVTOL).** *The system generated by*

$$\begin{aligned} \ddot{x} &= -u_1 \sin \theta + \varepsilon u_2 \cos \theta \\ \ddot{z} &= u_1 \cos \theta + \varepsilon u_2 \sin \theta - 1 \\ \ddot{\theta} &= u_2. \end{aligned}$$

*is globally equivalent to the systems generated by*

$$\ddot{y}_1 = -\xi \sin \theta, \quad \ddot{y}_2 = \xi \cos \theta - 1,$$

*where  $\xi$  and  $\theta$  are the control inputs. Indeed, setting*

$$\begin{aligned} X &:= (x, z, \dot{x}, \dot{z}, \theta, \dot{\theta}) & \text{and} & & Y &:= (y_1, y_2, \dot{y}_1, \dot{y}_2) \\ U &:= (u_1, u_2) & & & V &:= (\xi, \theta) \end{aligned}$$

and using the notations in the discussion after definition 2, we define the mappings  $Y = \psi(X, \bar{U})$  and  $V = \beta(X, \bar{U})$  by

$$\psi(X, \bar{U}) := \begin{pmatrix} x - \varepsilon \sin \theta \\ z + \varepsilon \cos \theta \\ \dot{x} - \varepsilon \dot{\theta} \cos \theta \\ \dot{z} - \varepsilon \dot{\theta} \sin \theta \end{pmatrix} \quad \text{and} \quad \beta(X, \bar{U}) := \begin{pmatrix} u_1 - \varepsilon \dot{\theta}^2 \\ \theta \end{pmatrix}$$

to generate the mapping  $\Psi$ . The inverse mapping  $\Phi$  is generated by the mappings  $X = \varphi(Y, \bar{V})$  and  $U = \alpha(Y, \bar{V})$  defined by

$$\varphi(Y, \bar{V}) := \begin{pmatrix} y_1 + \varepsilon \sin \theta \\ y_2 - \varepsilon \cos \theta \\ \dot{y}_1 + \varepsilon \dot{\theta} \cos \theta \\ \dot{y}_2 - \varepsilon \dot{\theta} \sin \theta \\ \theta \\ \dot{\theta} \end{pmatrix} \quad \text{and} \quad \alpha(Y, \bar{V}) := \begin{pmatrix} \xi + \varepsilon \dot{\theta}^2 \\ \ddot{\theta} \end{pmatrix}$$

An important property of endogenous transformations is that they preserve the input dimension:

**Theorem 1.** *If two systems  $(X \times U \times \mathbb{R}_m^\infty, F)$  and  $(Y \times V \times \mathbb{R}_s^\infty, G)$  are equivalent, then they have the same number of inputs, i.e.,  $m = s$ .*

*Proof.* Consider the truncation  $\Phi_\mu$  of  $\Phi$  on  $X \times U \times (\mathbb{R}^m)^\mu$ ,

$$\begin{aligned} \Phi_\mu : X \times U \times (\mathbb{R}^{m+k})^\mu &\rightarrow Y \times V \times (\mathbb{R}^s)^\mu \\ (x, u, u^1, \dots, u^{k+\mu}) &\mapsto (\varphi, \alpha, \dot{\alpha}, \dots, \alpha^{(\mu)}), \end{aligned}$$

i.e., the first  $\mu + 2$  blocks of components of  $\Psi$ ;  $k$  is just a fixed ‘‘large enough’’ integer. Because  $\Psi$  is invertible,  $\Psi_\mu$  is a submersion for all  $\mu$ . Hence the dimension of the domain is greater than or equal to the dimension of the range,

$$n + m(k + \mu + 1) \geq s(\mu + 1) \quad \forall \mu > 0,$$

which implies  $m \geq s$ . Using the same idea with  $\Psi$  leads to  $s \geq m$ .  $\square$

**Remark 4.** *Our definition of equivalence is adapted from the notion of equivalence between diffieties. Given two diffieties  $(\mathfrak{M}, CT\mathfrak{M})$  and  $(\mathfrak{N}, CT\mathfrak{N})$ , we say that a smooth mapping  $\Psi$  from (an open subset of)  $\mathfrak{M}$  to  $\mathfrak{N}$  is Lie-Bäcklund if its tangent mapping  $T\Psi$  satisfies  $T\Psi(CT\mathfrak{M}) \subset CT\mathfrak{N}$ . If moreover  $\Psi$  has a smooth inverse  $\Phi$  such that  $T\Psi(CT\mathfrak{N}) \subset CT\mathfrak{M}$ , we say it is a Lie-Bäcklund isomorphism. When such an isomorphism exists, the diffieties are said to be equivalent. An endogenous transformation is just a special Lie-Bäcklund isomorphism, which preserves the time parameterization of the integral curves. It is possible to define the more general concept of orbital equivalence [20, 18] by considering general Lie-Bäcklund isomorphisms, which preserve only the geometric locus of the integral curves.*

### 2.3 Differential Flatness

We single out a very important class of systems, namely systems equivalent to a trivial system  $(\mathbb{R}_s^\infty, F_s)$  (see example 1):

**Definition 3.** *The system  $(\mathfrak{M}, F)$  is flat at  $p \in \mathfrak{M}$  (resp. flat) if it equivalent at  $p$  (resp. equivalent) to a trivial system.*

We specialize the discussion after definition 2 to a flat system  $(X \times U \times \mathbb{R}_m^\infty, F)$  describing the dynamics

$$\dot{x} = f(x, u), \quad (x, u) \in X \times U \subset \mathbb{R}^n \times \mathbb{R}^m.$$

By definition the system is equivalent to the trivial system  $(\mathbb{R}_s^\infty, F_s)$  where the endogenous transformation  $\Psi$  takes the form

$$\Psi(x, u, u^1, \dots) = (h(x, \bar{u}), \dot{h}(x, \bar{u}), \ddot{h}(x, \bar{u}), \dots). \quad (7)$$

In other words  $\Psi$  is the infinite prolongation of the mapping  $h$ . The inverse  $\Phi$  of  $\Psi$  takes the form

$$\Psi(\bar{y}) = (\psi(\bar{y}), \beta(\bar{y}), \dot{\beta}(\bar{y}), \dots).$$

As  $\Phi$  and  $\Psi$  are inverse mappings we have in particular

$$\varphi(\bar{h}(x, \bar{u})) = x \quad \text{and} \quad \alpha(\bar{h}(x, \bar{u})) = u.$$

Moreover  $F$  and  $G$   $\Phi$ -related implies that whenever  $t \mapsto y(t)$  is a trajectory of  $y = v$  –i.e., nothing but an *arbitrary* mapping–

$$t \mapsto (x(t), u(t)) = (\psi(\bar{y}(t)), \beta(\bar{y}(t)))$$

is a trajectory of  $\dot{x} = f(x, u)$ , and vice versa.

We single out the importance of the mapping  $h$  of the previous example:

**Definition 4.** *Let  $(\mathfrak{M}, F)$  be a flat system and  $\Psi$  the endogenous transformation putting it into a trivial system. The first block of components of  $\Psi$ , i.e., the mapping  $h$  in (7), is called a flat (or linearizing) output.*

With this definition, an obvious consequence of theorem 1 is:

**Corollary 1.** *Consider a flat system. The dimension of a flat output is equal to the input dimension, i.e.,  $s = m$ .*

**Example 3 (The PVTOL).** *The system studied in example 2 is flat, with*

$$y = h(X, \bar{U}) := (x - \varepsilon \sin \theta, z + \varepsilon \cos \theta)$$

as a flat output. Indeed, the mappings  $X = \varphi(\bar{y})$  and  $U = \alpha(\bar{y})$  which generate the inverse mapping  $\Phi$  can be obtained from the implicit equations

$$\begin{aligned} (y_1 - x)^2 + (y_2 - z)^2 &= \varepsilon^2 \\ (y_1 - x)(\ddot{y}_2 + 1) - (y_2 - z)\ddot{y}_1 &= 0 \\ (\ddot{y}_2 + 1) \sin \theta + \ddot{y}_1 \cos \theta &= 0. \end{aligned}$$

We first solve for  $x, z, \theta$ ,

$$\begin{aligned} x &= y_1 + \varepsilon \frac{\ddot{y}_1}{\sqrt{\ddot{y}_1^2 + (\ddot{y}_2 + 1)^2}} \\ z &= y_2 + \varepsilon \frac{(\ddot{y}_2 + 1)}{\sqrt{\ddot{y}_1^2 + (\ddot{y}_2 + 1)^2}} \\ \theta &= \arg(\ddot{y}_1, \ddot{y}_2 + 1), \end{aligned}$$

and then differentiate to get  $\dot{x}, \dot{z}, \dot{\theta}, u$  in function of the derivatives of  $y$ . Notice the only singularity is  $\ddot{y}_1^2 + (\ddot{y}_2 + 1)^2 = 0$ .

## 2.4 Application to motion planning

We now illustrate how flatness can be used for solving control problems. Consider a nonlinear control system of the form

$$\dot{x} = f(x, u) \quad x \in \mathbb{R}^n, u \in \mathbb{R}^m$$

with flat output

$$y = h(x, u, \dot{u}, \dots, u^{(r)}).$$

By virtue of the system being flat, we can write all trajectories  $(x(t), u(t))$  satisfying the differential equation in terms of the flat output and its derivatives:

$$\begin{aligned} x &= \varphi(y, \dot{y}, \dots, y^{(q)}) \\ u &= \alpha(y, \dot{y}, \dots, y^{(q)}). \end{aligned}$$

We begin by considering the problem of steering from an initial state to a final state. We parameterize the components of the flat output  $y_i, i = 1, \dots, m$  by

$$y_i(t) := \sum_j A_{ij} \lambda_j(t), \quad (8)$$

where the  $\lambda_j(t), j = 1, \dots, N$  are basis functions. This reduces the problem from finding a function in an infinite dimensional space to finding a finite set of parameters.

Suppose we have available to us an initial state  $x_0$  at time  $\tau_0$  and a final state  $x_f$  at time  $\tau_f$ . Steering from an initial point in state space to a desired point in state space is trivial for flat systems. We have to calculate the values of the flat output and its derivatives from the desired points in state space and then solve for the coefficients  $A_{ij}$  in the following system of equations:

$$\begin{aligned} y_i(\tau_0) &= \sum_j A_{ij} \lambda_j(\tau_0) & y_i(\tau_f) &= \sum_j A_{ij} \lambda_j(\tau_f) \\ \vdots & & \vdots & \\ y_i^{(q)}(\tau_0) &= \sum_j A_{ij} \lambda_j^{(q)}(\tau_0) & y_i^{(q)}(\tau_f) &= \sum_j A_{ij} \lambda_j^{(q)}(\tau_f). \end{aligned} \quad (9)$$

To streamline notation we write the following expressions for the case of a *one*-dimensional flat output only. The multi-dimensional case follows by repeatedly applying the one-dimensional case, since the algorithm is decoupled in the component of the flat output. Let  $\Lambda(t)$  be the  $q+1$  by  $N$  matrix  $\Lambda_{ij}(t) = \lambda_j^{(i)}(t)$  and let

$$\begin{aligned}\bar{y}_0 &= (y_1(\tau_0), \dots, y_1^{(q)}(\tau_0)) \\ \bar{y}_f &= (y_1(\tau_f), \dots, y_1^{(q)}(\tau_f)) \\ \bar{y} &= (\bar{y}_0, \bar{y}_f).\end{aligned}\tag{10}$$

Then the constraint in equation (9) can be written as

$$\bar{y} = \begin{pmatrix} \Lambda(\tau_0) \\ \Lambda(\tau_f) \end{pmatrix} A =: \Lambda A.\tag{11}$$

That is, we require the coefficients  $A$  to be in an affine sub-space defined by equation (11). The only condition on the basis functions is that  $\Lambda$  is full rank, in order for equation (11) to have a solution.

The implications of flatness is that the trajectory generation problem can be reduced to simple algebra, in theory, and computationally attractive algorithms in practice. For example, in the case of the towed cable system [70], a reasonable state space representation of the system consists of approximately 128 states. Traditional approaches to trajectory generation, such as optimal control, cannot be easily applied in this case. However, it follows from the fact that the system is flat that the feasible trajectories of the system are completely characterized by the motion of the point at the bottom of the cable. By converting the input constraints on the system to constraints on the curvature and higher derivatives of the motion of the bottom of the cable, it is possible to compute efficient techniques for trajectory generation.

## 2.5 Motion planning with singularities

In the previous section we assumed the endogenous transformation

$$\Psi(x, u, u_1, \dots) := (h(x, \bar{u}), \dot{h}(x, \bar{u}), \ddot{h}(x, \bar{u}), \dots)$$

generated by the flat output  $y = h(x, \bar{u})$  everywhere nonsingular, so that we could invert it and express  $x$  and  $u$  in function of  $y$  and its derivatives,

$$(y, \dot{y}, \dots, y^{(q)}) \mapsto (x, u) = \phi(y, \dot{y}, \dots, y^{(q)}).$$

But it may well be that a singularity is in fact an interesting point of operation. As  $\phi$  is not defined at such a point, the previous computations do not apply. A way to overcome the problem is to “blow up” the singularity by considering trajectories  $t \mapsto y(t)$  such that

$$t \mapsto \phi(y(t), \dot{y}(t), \dots, y^{(q)}(t))$$

can be prolonged into a smooth mapping at points where  $\phi$  is not defined. To do so requires a detailed study of the singularity. A general statement is beyond the scope of this paper and we simply illustrate the idea with an example.

**Example 4.** Consider the flat dynamics

$$\dot{x}_1 = u_1, \quad \dot{x}_2 = u_2 u_1, \quad \dot{x}_3 = x_2 u_1,$$

with flat output  $y := (x_1, x_3)$ . When  $u_1 = 0$ , i.e.,  $\dot{y}_1 = 0$  the endogenous transformation generated by the flat output is singular and the inverse mapping

$$(y, \dot{y}, \ddot{y}) \xrightarrow{\phi} (x_1, x_2, x_3, u_1, u_2) = \left( y_1, \frac{\dot{y}_2}{\dot{y}_1}, y_2, \dot{y}_1, \frac{\ddot{y}_2 \dot{y}_1 - \ddot{y}_1 \dot{y}_2}{\dot{y}_1^3} \right),$$

is undefined. But if we consider trajectories  $t \mapsto y(t) := (\sigma(t), p(\sigma(t)))$ , with  $\sigma$  and  $p$  smooth functions, we find that

$$\frac{\dot{y}_2(t)}{\dot{y}_1(t)} = \frac{\frac{dp}{d\sigma}(\sigma(t)) \cdot \dot{\sigma}(t)}{\dot{\sigma}(t)} \quad \text{and} \quad \frac{\ddot{y}_2 \dot{y}_1 - \ddot{y}_1 \dot{y}_2}{\dot{y}_1^3} = \frac{\frac{d^2 p}{d\sigma^2}(\sigma(t)) \cdot \dot{\sigma}^3(t)}{\dot{\sigma}^3(t)},$$

hence we can prolong  $t \mapsto \phi(y(t), \dot{y}(t), \ddot{y}(t))$  everywhere by

$$t \mapsto \left( \sigma(t), \frac{dp}{d\sigma}(\sigma(t)), p(\sigma(t)), \dot{\sigma}(t), \frac{d^2 p}{d\sigma^2}(\sigma(t)) \right).$$

The motion planning can now be done as in the previous section: indeed, the functions  $\sigma$  and  $p$  and their derivatives are constrained at the initial (resp. final) time by the initial (resp. final) point but otherwise arbitrary.

For a more substantial application see [97, 98, 22], where the same idea was applied to nonholonomic mechanical systems by taking advantage of the “natural” geometry of the problem.

## 3 Feedback design with equivalence

### 3.1 From equivalence to feedback

The equivalence relation we have defined is very natural since it is essentially a 1 – 1 correspondence between trajectories of systems. We had mainly an open-loop point of view. We now turn to a closed-loop point of view by interpreting equivalence in terms of feedback. For that, consider the two dynamics

$$\begin{aligned} \dot{x} &= f(x, u), & (x, u) &\in X \times U \subset \mathbb{R}^n \times \mathbb{R}^m \\ \dot{y} &= g(y, v), & (y, v) &\in Y \times V \subset \mathbb{R}^r \times \mathbb{R}^s. \end{aligned}$$

They are described in our formalism by the systems  $(X \times U \times \mathbb{R}_m^\infty, F)$  and  $(Y \times V \times \mathbb{R}_s^\infty, G)$ , with  $F$  and  $G$  defined by

$$\begin{aligned} F(x, u, u^1, \dots) &:= (f(x, u), u^1, u^2, \dots) \\ G(y, v, v^1, \dots) &:= (g(y, v), v^1, v^2, \dots). \end{aligned}$$



Assume now the two systems are equivalent, i.e., they have the same trajectories. Does it imply that it is possible to go from  $\dot{x} = f(x, u)$  to  $\dot{y} = g(y, v)$  by a (possibly) dynamic feedback

$$\begin{aligned}\dot{z} &= a(x, z, v), \quad z \in Z \subset \mathbb{R}^q \\ u &= \kappa(x, z, v),\end{aligned}$$

and *vice versa*? The question might look stupid at first glance since such a feedback can only increase the state dimension. Yet, we can give it some sense if we agree to work “up to pure integrators” (remember this does not change the system in our formalism, see the remark after definition 1).

**Theorem 2.** *Assume  $\dot{x} = f(x, u)$  and  $\dot{y} = g(y, v)$  are equivalent. Then  $\dot{x} = f(x, u)$  can be transformed by (dynamic) feedback and coordinate change into*

$$\dot{y} = g(y, v), \quad \dot{v} = v^1, \quad \dot{v}^1 = v^2, \quad \dots, \quad \dot{v}^\mu = w$$

for some large enough integer  $\mu$ . Conversely,  $\dot{y} = g(y, v)$  can be transformed by (dynamic) feedback and coordinate change into

$$\dot{x} = f(x, u), \quad \dot{u} = u^1, \quad \dot{u}^1 = u^2, \quad \dots, \quad \dot{u}^\nu = w$$

for some large enough integer  $\nu$ .

*Proof* [53]. Denote by  $F$  and  $G$  the infinite vector fields representing the two dynamics. Equivalence means there is an invertible mapping

$$\Phi(y, \bar{v}) = (\varphi(y, \bar{v}), \alpha(y, \bar{v}), \dot{\alpha}(y, \bar{v}), \dots)$$

such that

$$F(\Phi(y, \bar{v})) = D\Phi(y, \bar{v}).G(y, \bar{v}). \quad (12)$$

Let  $\tilde{y} := (y, v, v^1, \dots, v^\mu)$  and  $w := v^{\mu+1}$ . For  $\mu$  large enough,  $\varphi$  (resp.  $\alpha$ ) depends only on  $\tilde{y}$  (resp. on  $\tilde{y}$  and  $w$ ). With these notations,  $\Phi$  reads

$$\Phi(\tilde{y}, \bar{w}) = (\varphi(\tilde{y}), \alpha(\tilde{y}, w), \dot{\alpha}(\tilde{y}, w), \dots),$$

and equation (12) implies in particular

$$f(\varphi(\tilde{y}), \alpha(\tilde{y}, w)) = D\varphi(\tilde{y}).\tilde{g}(\tilde{y}, w), \quad (13)$$

where  $\tilde{g} := (g, v^1, \dots, v^\mu)$ . Because  $\Phi$  is invertible,  $\varphi$  is full rank hence can be completed by some map  $\pi$  to a coordinate change

$$\tilde{y} \mapsto \phi(\tilde{y}) = (\varphi(\tilde{y}), \pi(\tilde{y})).$$

Consider now the dynamic feedback

$$\begin{aligned}u &= \alpha(\phi^{-1}(x, z), w) \\ \dot{z} &= D\pi(\phi^{-1}(x, z)).\tilde{g}(\phi^{-1}(x, z), w),\end{aligned}$$

which transforms  $\dot{x} = f(x, u)$  into

$$\begin{pmatrix} \dot{x} \\ \dot{z} \end{pmatrix} = \tilde{f}(x, z, w) := \begin{pmatrix} f(x, \alpha(\phi^{-1}(x, z), w)) \\ D\pi(\phi^{-1}(x, z)) \cdot \tilde{g}(\phi^{-1}(x, z), w) \end{pmatrix}.$$

Using (13), we have

$$\tilde{f}(\phi(\tilde{y}), w) = \begin{pmatrix} f(\varphi(\tilde{y}), \alpha(\tilde{y}, w)) \\ D\pi(\tilde{y}) \cdot \tilde{g}(\tilde{y}, w) \end{pmatrix} = \begin{pmatrix} D\varphi(\tilde{y}) \\ D\pi(\tilde{y}) \end{pmatrix} \cdot \tilde{g}(\tilde{y}, w) = D\phi(\tilde{y}) \cdot \tilde{g}(\tilde{y}, w).$$

Therefore  $\tilde{f}$  and  $\tilde{g}$  are  $\phi$ -related, which ends the proof. Exchanging the roles of  $f$  and  $g$  proves the converse statement.  $\square$

As a flat system is equivalent to a trivial one, we get as an immediate consequence of the theorem:

**Corollary 2.** *A flat dynamics can be linearized by (dynamic) feedback and coordinate change.*

**Remark 5.** *As can be seen in the proof of the theorem there are many feedbacks realizing the equivalence, as many as suitable mappings  $\pi$ . Notice all these feedback explode at points where  $\varphi$  is singular (i.e., where its rank collapses).*

*Further details about the construction of a linearizing feedback from an output and the links with extension algorithms can be found in [55].*

**Example 5 (The PVTOL).** *We know from example 3 that the dynamics*

$$\begin{aligned} \ddot{x} &= -u_1 \sin \theta + \varepsilon u_2 \cos \theta \\ \ddot{z} &= u_1 \cos \theta + \varepsilon u_2 \sin \theta - 1 \\ \ddot{\theta} &= u_2 \end{aligned}$$

*admits the flat output*

$$y = (x - \varepsilon \sin \theta, z + \varepsilon \cos \theta).$$

*It is transformed into the linear dynamics*

$$y_1^{(4)} = v_1, \quad y_2^{(4)} = v_2$$

*by the feedback*

$$\begin{aligned} \ddot{\xi} &= -v_1 \sin \theta + v_2 \cos \theta + \xi \dot{\theta}^2 \\ u_1 &= \xi + \varepsilon \dot{\theta}^2 \\ u_2 &= \frac{-1}{\xi} (v_1 \cos \theta + v_2 \sin \theta + 2\xi \dot{\theta}) \end{aligned}$$

*and the coordinate change*

$$(x, z, \theta, \dot{x}, \dot{z}, \dot{\theta}, \xi, \dot{\xi}) \mapsto (y, \dot{y}, \ddot{y}, y^{(3)}).$$

*The only singularity of this transformation is  $\xi = 0$ , i.e.,  $\dot{y}_1^2 + (\dot{y}_2 + 1)^2 = 0$ . Notice the PVTOL is not linearizable by static feedback.*

### 3.2 Endogenous feedback

Theorem 2 asserts the existence of a feedback such that

$$\begin{aligned}\dot{x} &= f(x, \kappa(x, z, w)) \\ \dot{z} &= a(x, z, w).\end{aligned}\tag{14}$$

reads, up to a coordinate change,

$$\dot{y} = g(y, v), \quad \dot{v} = v^1, \quad \dots, \quad \dot{v}^\mu = w.\tag{15}$$

But (15) is trivially equivalent to  $\dot{y} = g(y, v)$  (see the remark after definition 1), which is itself equivalent to  $\dot{x} = f(x, u)$ . Hence, (14) is equivalent to  $\dot{x} = f(x, u)$ . This leads to

**Definition 5.** *Consider the dynamics  $\dot{x} = f(x, u)$ . We say the feedback*

$$\begin{aligned}u &= \kappa(x, z, w) \\ \dot{z} &= a(x, z, w)\end{aligned}$$

*is endogenous if the open-loop dynamics  $\dot{x} = f(x, u)$  is equivalent to the closed-loop dynamics*

$$\begin{aligned}\dot{x} &= f(x, \kappa(x, z, w)) \\ \dot{z} &= a(x, z, w).\end{aligned}$$

The word “endogenous” reflects the fact that the feedback variables  $z$  and  $w$  are in loose sense “generated” by the original variables  $x, \bar{u}$  (see [53, 56] for further details and a characterization of such feedbacks)

**Remark 6.** *It is also possible to consider at no extra cost “generalized” feedbacks depending not only on  $w$  but also on derivatives of  $w$ .*

We thus have a more precise characterization of equivalence and flatness:

**Theorem 3.** *Two dynamics  $\dot{x} = f(x, u)$  and  $\dot{y} = g(y, v)$  are equivalent if and only if  $\dot{x} = f(x, u)$  can be transformed by endogenous feedback and coordinate change into*

$$\dot{y} = g(y, v), \quad \dot{v} = v^1, \quad \dots, \quad \dot{v}^\mu = w.\tag{16}$$

*for some large enough integer  $\nu$ , and vice versa.*

**Corollary 3.** *A dynamics is flat if and only if it is linearizable by endogenous feedback and coordinate change.*

Another trivial but important consequence of theorem 2 is that an endogenous feedback can be “unraveled” by another endogenous feedback:

**Corollary 4.** *Consider a dynamics*

$$\begin{aligned}\dot{x} &= f(x, \kappa(x, z, w)) \\ \dot{z} &= a(x, z, w)\end{aligned}$$

where

$$\begin{aligned}u &= \kappa(x, z, w) \\ \dot{z} &= a(x, z, w)\end{aligned}$$

is an endogenous feedback. Then it can be transformed by endogenous feedback and coordinate change into

$$\dot{x} = f(x, u), \quad \dot{u} = u^1, \quad \dots, \quad \dot{u}^\mu = w. \quad (17)$$

for some large enough integer  $\mu$ .

This clearly shows which properties are preserved by equivalence: properties that are preserved by adding pure integrators and coordinate changes, in particular controllability.

An endogenous feedback is thus truly “reversible”, up to pure integrators. It is worth pointing out that a feedback which is *invertible* in the sense of the standard –but maybe unfortunate– terminology [77] is not necessarily endogenous. For instance the invertible feedback  $\dot{z} = v$ ,  $u = v$  acting on the scalar dynamics  $\dot{x} = u$  is not endogenous. Indeed, the closed-loop dynamics  $\dot{x} = v$ ,  $\dot{z} = v$  is no longer controllable, and there is no way to change that by another feedback!

### 3.3 Tracking: feedback linearization

One of the central problems of control theory is *trajectory tracking*: given a dynamics  $\dot{x} = f(x, u)$ , we want to design a controller able to track any reference trajectory  $t \mapsto (x_r(t), u_r(t))$ . If this dynamics admits a flat output  $y = h(x, \bar{u})$ , we can use corollary 2 to transform it by (endogenous) feedback and coordinate change into the linear dynamics  $y^{(\mu+1)} = w$ . Assigning then

$$v := y_r^{(\mu+1)}(t) - K \Delta \tilde{y}$$

with a suitable gain matrix  $K$ , we get the stable closed-loop error dynamics

$$\Delta y^{(\mu+1)} = -K \Delta \tilde{y},$$

where  $y_r(t) := (x_r(t), \bar{u}_r(t))$  and  $\tilde{y} := (y, \dot{y}, \dots, y^{(\mu)})$  and  $\Delta \xi$  stands for  $\xi - \xi_r(t)$ . This control law meets the design objective. Indeed, there is by the definition of flatness an invertible mapping

$$\Phi(\bar{y}) = (\varphi(\bar{y}), \alpha(\bar{y}), \dot{\alpha}(\bar{y}), \dots)$$

relating the infinite dimension vector fields  $F(x, \bar{u}) := (f(x, u), u, u^1, \dots)$  and  $G(\bar{y}) := (y, y^1, \dots)$ . From the proof of theorem 2, this means in particular

$$\begin{aligned} x &= \varphi(\tilde{y}_r(t) + \Delta\tilde{y}) \\ &= \varphi(\tilde{y}_r(t)) + R_\varphi(y_r(t), \Delta\tilde{y}) \cdot \Delta\tilde{y} \\ &= x_r(t) + R_\varphi(y_r(t), \Delta\tilde{y}) \cdot \Delta\tilde{y} \end{aligned}$$

and

$$\begin{aligned} u &= \alpha(\tilde{y}_r(t) + \Delta\tilde{y}, -K\Delta\tilde{y}) \\ &= \alpha(\tilde{y}_r(t)) + R_\alpha(y_r^{(\mu+1)}(t), \Delta\tilde{y}) \cdot \begin{pmatrix} \Delta\tilde{y} \\ -K\Delta\tilde{y} \end{pmatrix} \\ &= u_r(t) + R_\alpha(\tilde{y}_r(t), y_r^{(\mu+1)}(t), \Delta\tilde{y}, \Delta w) \cdot \begin{pmatrix} \Delta\tilde{y} \\ -K\Delta\tilde{y} \end{pmatrix}, \end{aligned}$$

where we have used the fundamental theorem of calculus to define

$$\begin{aligned} R_\varphi(Y, \Delta Y) &:= \int_0^1 D\varphi(Y + t\Delta Y) dt \\ R_\alpha(Y, w, \Delta Y, \Delta w) &:= \int_0^1 D\alpha(Y + t\Delta Y, w + t\Delta w) dt. \end{aligned}$$

Since  $\Delta y \rightarrow 0$  as  $t \rightarrow \infty$ , this means  $x \rightarrow x_r(t)$  and  $u \rightarrow u_r(t)$ . Of course the tracking gets poorer and poorer as the ball of center  $\tilde{y}_r(t)$  and radius  $\Delta y$  approaches a singularity of  $\varphi$ . At the same time the control effort gets larger and larger, since the feedback explodes at such a point (see the remark after theorem 2). Notice the tracking quality and control effort depend only on the mapping  $\Phi$ , hence on the flat output, and not on the feedback itself.

We end this section with some comments on the use of feedback linearization. A linearizing feedback should always be fed by a *trajectory generator*, even if the original problem is not stated in terms of tracking. For instance, if it is desired to *stabilize* an equilibrium point, applying directly feedback linearization without first planning a reference trajectory yields very large control effort when starting from a distant initial point. The role of the trajectory generator is to define an *open-loop* “reasonable” trajectory –i.e., satisfying some state and/or control constraints– that the linearizing feedback will then track.

### 3.4 Tracking: singularities and time scaling

Tracking by feedback linearization is possible only far from singularities of the endogenous transformation generated by the flat output. If the reference trajectory passes through or near a singularity, then feedback linearization cannot be directly applied, as is the case for motion planning, see section 2.5. Nevertheless, it can be used after a *time scaling*, at least in the presence of “simple” singularities. The interest is that it allows exponential tracking, though in a new “singular” time.

**Example 6.** Take a reference trajectory  $t \mapsto y_r(t) = (\sigma(t), p(\sigma(t)))$  for example 4. Consider the dynamic time-varying compensator  $u_1 = \xi \dot{\sigma}(t)$  and  $\xi = v_1 \dot{\sigma}(t)$ . The closed loop system reads

$$x'_1 = \xi, \quad x'_2 = u_2 \xi, \quad x'_3 = x_2 \xi \quad \xi' = v_1.$$

where  $'$  stands for  $d/d\sigma$ , the extended state is  $(x_1, x_2, x_3, \xi)$ , the new control is  $(v_1, v_2)$ . An equivalent second order formulation is

$$x''_1 = v_1, \quad x''_3 = u_2 \xi^2 + x_2 v_1.$$

When  $\xi$  is far from zero, the static feedback  $u_2 = (v_2 - x_2 v_1)/\xi^2$  linearizes the dynamics,

$$x''_1 = v_1, \quad x''_3 = v_2$$

in  $\sigma$  scale. When the system remains close to the reference,  $\xi \approx 1$ , even if for some  $t$ ,  $\dot{\sigma}(t) = 0$ . Take

$$\begin{aligned} v_1 &= 0 - \text{sign}(\sigma) a_1 (\xi - 1) - a_2 (x_1 - \sigma) \\ v_2 &= \frac{d^2 p}{d\sigma^2} - \text{sign}(\sigma) a_1 \left( x_2 \xi - \frac{dp}{d\sigma} \right) - a_2 (x_3 - p) \end{aligned} \quad (18)$$

with  $a_1 > 0$  and  $a_2 > 0$ , then the error dynamics becomes exponentially stable in  $\sigma$ -scale (the term  $\text{sign}(\sigma)$  is for dealing with  $\dot{\sigma} < 0$ ).

Similar computations for trailer systems can be found in [21, 18].

Notice that linearizing controller can be achieved via quasi-static feedback as proposed in [15].

### 3.5 Tracking: flatness and backstepping

#### 3.5.1 Some drawbacks of feedback linearization

We illustrate on two simple (and caricatural) examples that feedback linearization may not lead to the best tracking controller in terms of control effort.

**Example 7.** Assume we want to track any trajectory  $t \mapsto (x_r(t), u_r(t))$  of

$$\dot{x} = -x - x^3 + u, \quad x \in \mathbb{R}.$$

The linearizing feedback

$$\begin{aligned} u &= x + x^3 - k \Delta x + \dot{x}_r(t) \\ &= u_r(t) + 3x_r(t) \Delta x^2 + (1 + 3x_r^2(t) - k) \Delta x + \Delta x^3 \end{aligned}$$

meets this objective by imposing the closed-loop dynamics  $\Delta \dot{x} = -k \Delta x$ .

But a closer inspection shows the open-loop error dynamics

$$\begin{aligned} \Delta \dot{x} &= - (1 + 3x_r^2(t)) \Delta x - \Delta x^3 + 3x_r(t) \Delta x^2 + \Delta u \\ &= -\Delta x (1 + 3x_r^2(t) - 3x_r(t) \Delta x + \Delta x^2) + \Delta u \end{aligned}$$

is naturally stable when the open-loop control  $u := u_r(t)$  is applied (indeed  $1 + 3x_r^2(t) - 3x_r(t) \Delta x + \Delta x^2$  is always strictly positive). In other words, the linearizing feedback does not take advantage of the natural damping effects.

**Example 8.** Consider the dynamics

$$\dot{x}_1 = u_1, \quad \dot{x}_2 = u_2(1 - u_1),$$

for which it is required to track an arbitrary trajectory  $t \mapsto (x_r(t), u_r(t))$  (notice  $u_r(t)$  may not be so easy to define because of the singularity  $u_1 = 1$ ). The linearizing feedback

$$u_1 = -k\Delta x_1 + \dot{x}_{1r}(t)$$

$$u_2 = \frac{-k\Delta x_2 + \dot{x}_{2r}(t)}{1 + k\Delta x_1 - \dot{x}_{1r}(t)}$$

meets this objective by imposing the closed-loop dynamics  $\Delta\dot{x} = -k\Delta x$ . Unfortunately  $u_2$  grows unbounded as  $u_1$  approaches one. This means we must in practice restrict to reference trajectories such that  $|1 - u_{1r}(t)|$  is always “large” –in particular it is impossible to cross the singularity– and to a “small” gain  $k$ .

A smarter control law can do away with these limitations. Indeed, considering the error dynamics

$$\Delta\dot{x}_1 = \Delta u_1$$

$$\Delta\dot{x}_2 = (1 - u_{1r}(t) - \Delta u_1)\Delta u_2 - u_{2r}(t)\Delta u_1,$$

and differentiating the positive function  $V(\Delta x) := \frac{1}{2}(\Delta x_1^2 + \Delta x_2^2)$  we get

$$\dot{V} = \Delta u_1(\Delta x_1 - u_{2r}(t)\Delta x_2) + (1 - u_{1r}(t) - \Delta u_1)\Delta u_1\Delta u_2.$$

The control law

$$\Delta u_1 = -k(\Delta x_1 - u_{2r}(t)\Delta x_2)$$

$$\Delta u_2 = -(1 - u_{1r}(t) - \Delta u_1)\Delta x_2$$

does the job since

$$\dot{V} = -(\Delta x_1 - u_{2r}(t)\Delta x_2)^2 - ((1 - u_{1r}(t) - \Delta u_1)\Delta x_2)^2 \leq 0.$$

Moreover, when  $u_{1r}(t) \neq 0$ ,  $\dot{V}$  is zero if and only if  $\|\Delta x\|$  is zero. It is thus possible to cross the singularity –which has been made an unstable equilibrium of the closed-loop error dynamics– and to choose the gain  $k$  as large as desired. Notice the singularity is overcome by a “truly” multi-input design.

It should not be inferred from the previous examples that feedback linearization necessarily leads to inefficient tracking controllers. Indeed, when the trajectory generator is well-designed, the system is always close to the reference trajectory. Singularities are avoided by restricting to reference trajectories which stay away from them. This makes sense in practice when singularities do not correspond to interesting regions of operations. In this case, designing a tracking controller “smarter” than a linearizing feedback often turns out to be rather complicated, if possible at all.

### 3.5.2 Backstepping

The previous examples are rather trivial because the control input has the same dimension as the state. More complicated systems can be handled by *backstepping*. Backstepping is a versatile design tool which can be helpful in a variety of situations: stabilization, adaptive or output feedback, etc ([41] for a complete survey). It relies on the simple yet powerful following idea: consider the system

$$\begin{aligned}\dot{x} &= f(x, \xi), & f(x_0, \xi_0) &= 0 \\ \dot{\xi} &= u,\end{aligned}$$

where  $(x, \xi) \in \mathbb{R}^n \times \mathbb{R}$  is the state and  $u \in \mathbb{R}$  the control input, and assume we can asymptotically stabilize the equilibrium  $x_0$  of the subsystem  $\dot{x} = f(x, \xi)$ , i.e., we know a control law  $\xi = \alpha(x)$ ,  $\alpha(x_0) = \xi_0$  and a positive function  $V(x)$  such that

$$\dot{V} = DV(x).f(x, \alpha(x)) \leq 0.$$

A key observation is that the “virtual” control input  $\xi$  can then “backstepped” to stabilize the equilibrium  $(x_0, \xi_0)$  of the complete system. Indeed, introducing the positive function

$$W(x, \xi) := V(x) + \frac{1}{2}(\xi - \alpha(x))^2$$

and the error variable  $z := \xi - \alpha(x)$ , we have

$$\begin{aligned}\dot{W} &= DV(x).f(x, \alpha(x) + z) + z(u - \dot{\alpha}(x, \xi)) \\ &= DV(x).(f(x, \alpha(x)) + R(x, z).z) + z(u - D\alpha(x).f(x, \xi)) \\ &= \dot{V} + z(u - D\alpha(x).f(x, \xi) + DV(x).R(x, z)),\end{aligned}$$

where we have used the fundamental theorem of calculus to define

$$R(x, h) := \int_0^1 \frac{\partial f}{\partial \xi}(x, x + th) dt$$

(notice  $R(x, h)$  is trivially computed when  $f$  is linear in  $\xi$ ). As  $\dot{V}$  is negative by assumption, we can make  $\dot{W}$  negative, hence stabilize the system, by choosing for instance

$$u := -z + D\alpha(x).f(x, \xi) - DV(x).R(x, z).$$

### 3.5.3 Blending equivalence with backstepping

Consider a dynamics  $\dot{y} = g(y, v)$  for which we would like to solve the tracking problem. Assume it is equivalent to another dynamics  $\dot{x} = f(x, u)$  for which we can solve this problem, i.e., we know a tracking control law together with a Lyapunov function. How can we use this property to control  $\dot{y} = g(y, v)$ ?



Another formulation of the question is: assume we know a controller for  $\dot{x} = f(x, u)$ . How can we derive a controller for

$$\begin{aligned}\dot{x} &= f(x, \kappa(x, z, v)) \\ \dot{z} &= a(x, z, v),\end{aligned}$$

where  $u = \kappa(x, z, v)$ ,  $\dot{z} = a(x, z, v)$  is an endogenous feedback? Notice backstepping answers the question for the elementary case where the feedback in question is a pure integrator.

By theorem 2, we can transform  $\dot{x} = f(x, u)$  by (dynamic) feedback and coordinate change into

$$\dot{y} = g(y, v), \quad \dot{v} = v^1, \quad \dots, \quad \dot{v}^\mu = w. \quad (19)$$

for some large enough integer  $\mu$ . We can then trivially backstep the control from  $v$  to  $w$  and change coordinates. Using the same reasoning as in section 3.3, it is easy to prove this leads to a control law solving the tracking problem for  $\dot{x} = f(x, u)$ . In fact, this is essentially the method we followed in section 3.3 on the special case of a flat  $\dot{x} = f(x, u)$ . We illustrated in section 3.5.1 potential drawbacks of this approach.

However, it is often possible to design better –though in general more complicated– tracking controllers by suitably using backstepping. This point of view is extensively developed in [41], though essentially in the single-input case, where general equivalence boils down to equivalence by coordinate change. In the multi-input case new phenomena occur as illustrated by the following examples.

**Example 9 (The PVTOL).** *We know from example 2 that*

$$\begin{aligned}\ddot{x} &= -u_1 \sin \theta + \varepsilon u_2 \cos \theta \\ \ddot{z} &= u_1 \cos \theta + \varepsilon u_2 \sin \theta - 1 \\ \ddot{\theta} &= u_2\end{aligned} \quad (20)$$

*is globally equivalent to*

$$\ddot{y}_1 = -\xi \sin \theta, \quad \ddot{y}_2 = \xi \cos \theta - 1,$$

*where  $\xi = u_1 + \varepsilon \dot{\theta}^2$ . This latter form is rather appealing for designing a tracking controller and leads to the error dynamics*

$$\begin{aligned}\Delta \ddot{y}_1 &= -\xi \sin \theta + \xi_r(t) \sin \theta_r(t) \\ \Delta \ddot{y}_2 &= \xi \cos \theta - \xi_r(t) \cos \theta_r(t)\end{aligned}$$

*Clearly, if  $\theta$  were a control input, we could track trajectories by assigning*

$$\begin{aligned}-\xi \sin \theta &= \alpha_1(\Delta y_1, \Delta \dot{y}_1) + \ddot{y}_{1r}(t) \\ \xi \cos \theta &= \alpha_2(\Delta y_2, \Delta \dot{y}_2) + \ddot{y}_{2r}(t)\end{aligned}$$

for suitable functions  $\alpha_1, \alpha_2$  and find a Lyapunov function  $V(\Delta y, \Delta \dot{y})$  for the system. In other words, we would assign

$$\begin{aligned}\xi &= \Xi(\Delta y, \Delta \dot{y}, \ddot{y}_r(t)) := \sqrt{(\alpha_1 + \ddot{y}_{1r})^2 + (\alpha_2 + \ddot{y}_{2r})^2} \\ \theta &= \Theta(\Delta y, \Delta \dot{y}, \ddot{y}_r(t)) := \arg(\alpha_1 + \ddot{y}_{1r}, \alpha_2 + \ddot{y}_{2r}).\end{aligned}\quad (21)$$

The angle  $\theta$  is a priori not defined when  $\xi = 0$ , i.e., at the singularity of the flat output  $y$ . We will not discuss the possibility of overcoming this singularity and simply assume we stay away from it. Aside from that, there remains a big problem: how should the “virtual” control law (21) be understood? Indeed, it seems to be a differential equation: because  $y$  depends on  $\theta$ , hence  $\Xi$  and  $\Theta$  are in fact functions of the variables

$$x, \dot{x}, z, \dot{z}, \theta, \dot{\theta}, y_r(t), \dot{y}_r(t), \ddot{y}_r(t).$$

Notice  $\xi$  is related to the actual control  $u_1$  by a relation that also depends on  $\dot{\theta}$ .

Let us forget this apparent difficulty for the time being and backstep (21) the usual way. Introducing the error variable  $\kappa_1 := \theta - \Theta(\Delta y, \Delta \dot{y}, \ddot{y}_r(t))$  and using the fundamental theorem of calculus, the error dynamics becomes

$$\begin{aligned}\Delta \ddot{y}_1 &= \alpha_1(\Delta y_1, \Delta \dot{y}_1) - \kappa_1 R_{\sin}(\Theta(\Delta y, \Delta \dot{y}, \ddot{y}_r(t)), \kappa_1) \Xi(\Delta y, \Delta \dot{y}, \ddot{y}_r(t)) \\ \Delta \ddot{y}_2 &= \alpha_2(\Delta y_1, \Delta \dot{y}_1) + \kappa_1 R_{\cos}(\Theta(\Delta y, \Delta \dot{y}, \ddot{y}_r(t)), \kappa_1) \Xi(\Delta y, \Delta \dot{y}, \ddot{y}_r(t)) \\ \dot{\kappa}_1 &= \dot{\theta} - \dot{\Theta}(\kappa_1, \Delta y, \Delta \dot{y}, \ddot{y}_r(t), y_r^{(3)}(t))\end{aligned}$$

Notice the functions

$$\begin{aligned}R_{\sin}(x, h) &= \sin x \frac{\cos h - 1}{h} + \cos x \frac{\sin h}{h} \\ R_{\cos}(x, h) &= \cos x \frac{\cos h - 1}{h} - \sin x \frac{\sin h}{h}\end{aligned}$$

are bounded and analytic. Differentiate now the positive function

$$V_1(\Delta y, \Delta \dot{y}, \kappa_1) := V(\Delta y, \Delta \dot{y}) + \frac{1}{2} \kappa_1^2$$

to get

$$\begin{aligned}\dot{V}_1 &= \frac{\partial V}{\partial \Delta y_1} \Delta \dot{y}_1 + \frac{\partial V}{\partial \Delta \dot{y}_1} (\alpha_1 - \kappa_1 R_{\sin} \Xi) + \\ &\quad \frac{\partial V}{\partial \Delta y_2} \Delta \dot{y}_2 + \frac{\partial V}{\partial \Delta \dot{y}_2} (\alpha_2 + \kappa_1 R_{\cos} \Xi) + \kappa_1 (\dot{\theta} - \dot{\Theta}) \\ &= \dot{V} + \kappa_1 \left( \dot{\theta} - \dot{\Theta} + \kappa_1 \left( R_{\cos} \frac{\partial V}{\partial \Delta y_1} - R_{\sin} \frac{\partial V}{\partial \Delta y_2} \right) \Xi \right),\end{aligned}$$

where we have omitted arguments of all the functions for the sake of clarity. If  $\dot{\theta}$  were a control input, we could for instance assign

$$\begin{aligned}\dot{\theta} &:= -\kappa_1 + \dot{\Theta} - \kappa_1 \left( R_{\cos} \frac{\partial V}{\partial \Delta y_1} - R_{\sin} \frac{\partial V}{\partial \Delta y_2} \right) \Xi \\ &:= \Theta_1(\kappa_1, \Delta y, \Delta \dot{y}, \ddot{y}_r(t), y_r^{(3)}(t)),\end{aligned}$$

to get  $\dot{V}_1 = \dot{V} - \kappa_1^2 \leq 0$ . We thus backstep this “virtual” control law: we introduce the error variable

$$\kappa_2 := \dot{\theta} - \Theta_1(\kappa_1, \Delta y, \Delta \dot{y}, \ddot{y}_r(t), y_r^{(3)}(t))$$

together with the positive function

$$V_2(\Delta y, \Delta \dot{y}, \kappa_1, \kappa_2) := V_1(\Delta y, \Delta \dot{y}, \kappa_1) + \frac{1}{2}\kappa_2^2.$$

Differentiating

$$\begin{aligned} V_2 &= \dot{V} + \kappa_1(-\kappa_1 + \kappa_2) + \kappa_2(v_2 - \dot{\Theta}_1) \\ &= \dot{V}_1 + \kappa_2(u_2 - \dot{\Theta}_1 + \kappa_2), \end{aligned}$$

and we can easily make  $\dot{V}_1$  negative by assigning

$$u_2 := \Theta_2(\kappa_1, \kappa_2, \Delta y, \Delta \dot{y}, \ddot{y}_r(t), y_r^{(3)}(t), y_r^{(4)}(t)) \quad (22)$$

for some suitable function  $\Theta_2$ .

A key observation is that  $\Theta_2$  and  $V_2$  are in fact functions of the variables

$$x, \dot{x}, z, \dot{z}, \theta, \dot{\theta}, y_r(t), \dots, y_r^{(4)}(t),$$

which means (22) makes sense. We have thus built a static control law

$$\begin{aligned} u_1 &= \Xi(x, \dot{x}, z, \dot{z}, \theta, \dot{\theta}, y_r(t), \dot{y}_r(t), \ddot{y}_r(t)) + \varepsilon \dot{\theta}^2 \\ u_2 &= \Theta_2(x, \dot{x}, z, \dot{z}, \theta, \dot{\theta}, y_r(t), \dots, y_r^{(4)}(t)) \end{aligned}$$

that does the tracking for (20). Notice it depends on  $y_r(t)$  up to the fourth derivative.

**Example 10.** *The dynamics*

$$\dot{x}_1 = u_1, \quad \dot{x}_2 = x_3(1 - u_1), \quad \dot{x}_3 = u_2,$$

admits  $(x_1, x_2)$  as a flat output. The corresponding endogenous transformation is singular, hence any linearizing feedback blows up, when  $u_1 = 1$ . However, it is easy to backstep the controller of example 8 to build a globally tracking static controller

**Remark 7.** Notice that none of the two previous examples can be linearized by static feedback. Dynamic feedback is necessary for that. Nevertheless we were able to derive static tracking control laws for them. An explanation of why this is possible is that a flat system can in theory be linearized by a quasistatic feedback [14] –provided the flat output does not depend on derivatives of the input–.

### 3.5.4 Backstepping and time-scaling

Backstepping can be combined with linearization and time-scaling, as illustrated in the following example.

**Example 11.** Consider example 4 and its tracking control defined in example 6. Assume, for example, that  $\dot{\sigma} \geq 0$ . With the dynamic controller

$$\dot{\xi} = v_1 \dot{\sigma}, \quad u_1 = \xi \dot{\sigma}, \quad u_2 = (v_2 - x_2 v_1) / \xi^2$$

where  $v_1$  and  $v_2$  are given by equation (18), we have, for the error  $e = y - y_r$ , a Lyapunov function  $V(e, de/d\sigma)$  satisfying

$$dV/d\sigma \leq -aV \tag{23}$$

with some constant  $a > 0$ . Remember that  $de/d\sigma$  corresponds to  $(\xi - 1, x_2 \xi - dp/d\sigma)$ . Assume now that the real control is not  $(u_1, u_2)$  but  $(\dot{u}_1 := w_1, u_2)$ . With the extended Lyapunov function

$$W = V(e, de/d\sigma) + \frac{1}{2}(u_1 - \xi \dot{\sigma})^2$$

we have

$$\dot{W} = \dot{V} + (w_1 - \dot{\xi} \dot{\sigma} - \xi \ddot{\sigma})(u_1 - \xi \dot{\sigma}).$$

Some manipulations show that

$$\dot{V} = (u_1 - \dot{\sigma} \xi) \left( \frac{\partial V}{\partial e_1} + \frac{\partial V}{\partial e_2} x_2 + \frac{\partial V}{\partial e'_2} u_2 \xi \right) + \dot{\sigma} \frac{dV}{d\sigma}$$

(remember  $\dot{\xi} = v_1 \dot{\sigma}$  and  $(v_1, v_2)$  are given by (18)). The feedback ( $b > 0$ )

$$w_1 = - \left( \frac{\partial V}{\partial e_1} + \frac{\partial V}{\partial e_2} x_2 + \frac{\partial V}{\partial e'_2} u_2 \xi \right) + \dot{\xi} \dot{\sigma} + \xi \ddot{\sigma} - b(u_1 - \xi \dot{\sigma})$$

achieves asymptotic tracking since  $\dot{W} \leq -a\dot{\sigma}V - b(u_1 - \xi \dot{\sigma})^2$ .

### 3.5.5 Conclusion

It is possible to generalize the previous examples to prove that a control law can be backstepped “through” any endogenous feedback. In particular a flat dynamics can be seen as a (generalized) endogenous feedback acting on the flat output; hence we can backstep a control law for the flat output through the whole dynamics. In other words the flat output serves as a first “virtual” control in the backstepping process. It is another illustration of the fact that a flat output “summarizes” the dynamical behavior.

Notice also that in a tracking problem the knowledge of a flat output is extremely useful not only for the tracking itself (i.e., the closed-loop problem) but also for the trajectory generation (i.e., the open-loop problem)

## 4 Checking flatness: an overview

### 4.1 The general problem

Devising a general computable test for checking whether  $\dot{x} = f(x, u), x \in \mathbb{R}^n, u \in \mathbb{R}^m$  is flat remains up to now an open problem. This means there are no systematic methods for constructing flat outputs. This does not make flatness a useless concept: for instance Lyapunov functions and uniform first integrals of dynamical systems are extremely helpful notions both from a theoretical and practical point of view though they cannot be systematically computed.

The main difficulty in checking flatness is that a candidate flat output  $y = h(x, u, \dots, u^{(r)})$  may a priori depend on derivatives of  $u$  of arbitrary order  $r$ . Whether this order  $r$  admits an upper bound (in terms of  $n$  and  $m$ ) is at the moment completely unknown. Hence we do not know whether a finite bound exists at all. In the sequel, we say a system is  $r$ -flat if it admits a flat output depending on derivatives of  $u$  of order at most  $r$ .

To illustrate this upper bound might be at least linear in the state dimension, consider the system

$$x_1^{(\alpha_1)} = u_1, \quad x_2^{(\alpha_2)} = u_2, \quad \dot{x}_3 = u_1 u_2$$

with  $\alpha_1 > 0$  and  $\alpha_2 > 0$ . It admits the flat output

$$y_1 = x_3 + \sum_{i=1}^{\alpha_1} (-1)^i x_1^{(\alpha_1-i)} u_2^{(i-1)}, \quad y_2 = x_2,$$

hence is  $r$ -flat with  $r := \min(\alpha_1, \alpha_2) - 1$ . We suspect (without proof) there is no flat output depending on derivatives of  $u$  of order less than  $r - 1$ .

If such a bound  $\kappa(n, m)$  were known, the problem would amount to checking  $p$ -flatness for a given  $p \leq \kappa(n, m)$  and could be solved in theory. Indeed, it consists [53] in finding  $m$  functions  $h_1, \dots, h_m$  depending on  $(x, u, \dots, u^{(p)})$  such that

$$\dim \text{span} \left\{ dx_1, \dots, dx_n, du_1, \dots, du_m, dh_1^{(\mu)}, \dots, dh_m^{(\mu)} \right\}_{0 \leq \mu \leq \nu} = m(\nu + 1),$$

where  $\nu := n + pm$ . This means checking the integrability of the partial differential system with a transversality condition

$$\begin{aligned} dx_i \wedge dh \wedge \dots \wedge dh^{(\nu)} &= 0, & i &= 1, \dots, n \\ du_j \wedge dh \wedge \dots \wedge dh^{(\nu)} &= 0, & j &= 1, \dots, m \\ dh \wedge \dots \wedge dh^{(\nu)} &\neq 0, \end{aligned}$$

where  $dh^{(\mu)}$  stands for  $dh_1^{(\mu)} \wedge \dots \wedge dh_m^{(\mu)}$ . It is in theory possible to conclude by using a computable criterion [5, 88], though this seems to lead to practically intractable calculations. Nevertheless it can be hoped that, due to the special structure of the above equations, major simplifications might appear.

## 4.2 Known results

### 4.2.1 Systems linearizable by static feedback.

A system which is linearizable by static feedback and coordinate change is clearly flat. Hence the geometric necessary and sufficient conditions in [38, 37] provide sufficient conditions for flatness. Notice a flat system is in general not linearizable by static feedback, with the major exception of the single-input case.

### 4.2.2 Single-input systems.

When there is only one control input flatness reduces to static feedback linearizability [10] and is thus completely characterized by the test in [38, 37].

### 4.2.3 Affine systems of codimension 1.

A system of the form

$$\dot{x} = f_0(x) + \sum_{j=1}^{n-1} u_j g_j(x), \quad x \in \mathbb{R}^n,$$

i.e., with one input less than states and linear w.r.t. the inputs is 0-flat as soon as it is controllable [10] (more precisely strongly accessible for almost every  $x$ ).

The picture is much more complicated when the system is not linear w.r.t. the control, see [54] for a geometric sufficient condition.

### 4.2.4 Affine systems with 2 inputs and 4 states.

Necessary and sufficient conditions for 1-flatness of the system can be found in [86]. They give a good idea of the complexity of checking  $r$ -flatness even for  $r$  small. Very recently J-B. Pomet and D. Avanesoff have shown that the above conditions are also necessary and sufficient conditions for  $r$ -flatness,  $r$  arbitrary. This means that, for control-affine systems with 4 states or general control systems with 3 state, flatness characterization is solved.

### 4.2.5 Driftless systems.

For driftless systems of the form  $\dot{x} = \sum_{i=1}^m f_i(x)u_i$  additional results are available.

**Theorem 4 (Driftless systems with two inputs [60]).** *The system*

$$\dot{x} = f_1(x)u_1 + f_2(x)u_2$$

*is flat if and only if the generic rank of  $E_k$  is equal to  $k+2$  for  $k = 0, \dots, n-2$  where  $E_0 := \text{span}\{f_1, f_2\}$ ,  $E_{k+1} := \text{span}\{E_k, [E_k, E_k]\}$ ,  $k \geq 0$ .*

A flat two-input driftless system is always 0-flat. As a consequence of a result in [72], a flat two-input driftless system satisfying some additional regularity conditions can be put by *static* feedback and coordinate change into the *chained system* [73]

$$\dot{x}_1 = u_1, \quad \dot{x}_2 = u_2, \quad \dot{x}_3 = x_2 u_1, \quad \dots, \quad \dot{x}_n = x_{n-1} u_1.$$

**Theorem 5 (Driftless systems,  $n$  states, and  $n - 2$  inputs [61, 62]).**

$$\dot{x} = \sum_{i=1}^{n-2} u_i f_i(x), \quad x \in \mathbb{R}^n$$

*is flat as soon as it is controllable (i.e., strongly accessible for almost every  $x$ ). More precisely it is 0-flat when  $n$  is odd, and 1-flat when  $n$  is even.*

All the results mentioned above rely on the use of exterior differential systems. Additional results on driftless systems, with applications to nonholonomic systems, can be found in [108, 107, 104].

#### 4.2.6 Mechanical systems.

For mechanical systems with one control input less than configuration variables, [92] provides a geometric characterization, in terms of the metric derived from the kinetic energy and the control codistribution, of flat outputs depending only on the configuration variables.

#### 4.2.7 A necessary condition.

Because it is not known whether flatness can be checked with a finite test, see section 4.1, it is very difficult to prove that a system is *not* flat. The following result provides a simple necessary condition.

**Theorem 6 (The ruled-manifold criterion [96, 22]).** *Assume  $\dot{x} = f(x, u)$  is flat. The projection on the  $p$ -space of the submanifold  $p = f(x, u)$ , where  $x$  is considered as a parameter, is a ruled submanifold for all  $x$ .*

The criterion just means that eliminating  $u$  from  $\dot{x} = f(x, u)$  yields a set of equations  $F(x, \dot{x}) = 0$  with the following property: for all  $(x, p)$  such that  $F(x, p) = 0$ , there exists  $a \in \mathbb{R}^n$ ,  $a \neq 0$  such that

$$\forall \lambda \in \mathbb{R}, \quad F(x, p + \lambda a) = 0.$$

$F(x, p) = 0$  is thus a ruled manifold containing straight lines of direction  $a$ .

The proof directly derives from the method used by Hilbert [35] to prove the second order Monge equation  $\frac{d^2 z}{dx^2} = \left(\frac{dy}{dx}\right)^2$  is not solvable without integrals.

A restricted version of this result was proposed in [105] for systems linearizable by a special class of dynamic feedbacks.

As crude as it may look, this criterion is up to now the only way –except for two-input driftless systems– to prove a multi-input system is not flat.

**Example 12.** *The system*

$$\dot{x}_1 = u_1, \quad \dot{x}_2 = u_2, \quad \dot{x}_3 = (u_1)^2 + (u_2)^3$$

*is not flat, since the submanifold  $p_3 = p_1^2 + p_2^3$  is not ruled: there is no  $a \in \mathbb{R}^3$ ,  $a \neq 0$ , such that*

$$\forall \lambda \in \mathbb{R}, p_3 + \lambda a_3 = (p_1 + \lambda a_1)^2 + (p_2 + \lambda a_2)^3.$$

*Indeed, the cubic term in  $\lambda$  implies  $a_2 = 0$ , the quadratic term  $a_1 = 0$  hence  $a_3 = 0$ .*

**Example 13.** *The system  $\dot{x}_3 = \dot{x}_1^2 + \dot{x}_2^2$  does not define a ruled submanifold of  $\mathbb{R}^3$ : it is not flat in  $\mathbb{R}$ . But it defines a ruled submanifold in  $\mathbb{C}^3$ : in fact it is flat in  $\mathbb{C}$ , with the flat output*

$$y = (x_3 - (\dot{x}_1 - \dot{x}_2\sqrt{-1})(x_1 + x_2\sqrt{-1}), x_1 + x_2\sqrt{-1}).$$

**Example 14 (The ball and beam [33]).** *We now prove by the ruled manifold criterion that*

$$\begin{aligned} \ddot{r} &= -Bg \sin \theta + Br\dot{\theta}^2 \\ (mr^2 + J + J_b)\ddot{\theta} &= \tau - 2mr\dot{r}\dot{\theta} - mgr \cos \theta, \end{aligned}$$

*where  $(r, \dot{r}, \theta, \dot{\theta})$  is the state and  $\tau$  the input, is not flat (as it is a single-input system, we could also prove it is not static feedback linearizable, see section 4.2.2). Eliminating the input  $\tau$  yields*

$$\dot{r} = v_r, \quad \dot{v}_r = -Bg \sin \theta + Br\dot{\theta}^2, \quad \dot{\theta} = v_\theta$$

*which defines a ruled manifold in the  $(\dot{r}, v_r, \dot{\theta}, v_\theta)$ -space for any  $r, v_r, \theta, v_\theta$ , and we cannot conclude directly. Yet, the system is obviously equivalent to*

$$\dot{r} = v_r, \quad \dot{v}_r = -Bg \sin \theta + Br\dot{\theta}^2,$$

*which clearly does not define a ruled submanifold for any  $(r, v_r, \theta)$ . Hence the system is not flat.*

## 5 State constraints and optimal control

### 5.1 Optimal control

Consider the standard optimal control problem

$$\min_u J(u) = \int_0^T L(x(t), u(t)) dt$$

together with  $\dot{x} = f(x, u)$ ,  $x(0) = a$  and  $x(T) = b$ , for known  $a, b$  and  $T$ .



Assume that  $\dot{x} = f(x, u)$  is flat with  $y = h(x, u, \dots, u^{(r)})$  as flat output,

$$x = \varphi(y, \dots, y^{(q)}), \quad u = \alpha(y, \dots, y^{(q)}).$$

A numerical resolution of  $\min_u J(u)$  a priori requires a discretization of the state space, i.e., a finite dimensional approximation. A better way is to discretize the flat output space. Set  $y_i(t) = \sum_1^N A_{ij} \lambda_j(t)$ . The initial and final conditions on  $x$  provide then initial and final constraints on  $y$  and its derivatives up to order  $q$ . These constraints define an affine sub-space  $V$  of the vector space spanned by the the  $A_{ij}$ 's. We are thus left with the nonlinear programming problem

$$\min_{A \in V} J(A) = \int_0^T L(\varphi(y, \dots, y^{(q)}), \alpha(y, \dots, y^{(q)})) dt,$$

where the  $y_i$ 's must be replaced by  $\sum_1^N A_{ij} \lambda_j(t)$ .

This methodology is used in [76] for trajectory generation and optimal control. It should also be very useful for predictive control. The main expected benefit is a dramatic improvement in computing time and numerical stability. Indeed the exact quadrature of the dynamics –corresponding here to exact discretization via well chosen input signals through the mapping  $\alpha$ – avoids the usual numerical sensitivity troubles during integration of  $\dot{x} = f(x, u)$  and the problem of satisfying  $x(T) = b$ . A systematic method exploiting flatness for predictive control is proposed in [25]. See also [81] for an industrial application of such methodology on a chemical reactor.

Recent numerical experiments [82, 65] (the Nonlinear Trajectory Generation (NTG) project at Caltech) indicate that substantial computing gains are obtained when flatness based parameterizations are employed.

## 5.2 State constraints and predictive control

In the previous section, we did not consider state constraints. We now turn to the problem of planning a trajectory steering the state from  $a$  to  $b$  while satisfying the constraint  $k(x, u, \dots, u^{(p)}) \leq 0$ . In the flat output “coordinates” this yields the following problem: find  $T > 0$  and a smooth function  $[0, T] \ni t \mapsto y(t)$  such that  $(y, \dots, y^{(q)})$  has prescribed value at  $t = 0$  and  $T$  and such that  $\forall t \in [0, T], K(y, \dots, y^{(\nu)})(t) \leq 0$  for some  $\nu$ . When  $q = \nu = 0$  this problem, known as the *piano mover problem*, is already very difficult.

Assume for simplicity sake that the initial and final states are equilibrium points. Assume also there is a quasistatic motion strictly satisfying the constraints: there exists a *path* (not a trajectory)  $[0, 1] \ni \sigma \mapsto Y(\sigma)$  such that  $Y(0)$  and  $Y(1)$  correspond to the initial and final point and for any  $\sigma \in [0, 1], K(Y(\sigma), 0, \dots, 0) < 0$ . Then, there exists  $T > 0$  and  $[0, T] \ni t \mapsto y(t)$  solution of the original problem. It suffices to take  $Y(\eta(t/T))$  where  $T$  is large enough, and where  $\eta$  is a smooth increasing function  $[0, 1] \ni s \mapsto \eta(s) \in [0, 1]$ , with  $\eta(0) = 0, \eta(1) = 1$  and  $\frac{d^i \eta}{ds^i}(0, 1) = 0$  for  $i = 1, \dots, \max(q, \nu)$ .

In [95] this method is applied to a two-input chemical reactor. In [90] the minimum-time problem under state constraints is investigated for several mechanical systems. [102] considers, in the context of non holonomic systems, the path planning problem with obstacles. Due to the nonholonomic constraints, the above quasistatic method fails: one cannot set the  $y$ -derivative to zero since they do not correspond to time derivatives but to arc-length derivatives. However, several numerical experiments clearly show that sorting the constraints with respect to the order of  $y$ -derivatives plays a crucial role in the computing performance.

## 6 Symmetries

### 6.1 Symmetry preserving flat output

Consider the dynamics  $\dot{x} = f(x, u)$ ,  $(x, u) \in X \times U \subset \mathbb{R}^n \times \mathbb{R}^m$ . It generates a system  $(F, \mathfrak{M})$ , where  $\mathfrak{M} := X \times U \times \mathbb{R}_m^\infty$  and  $F(x, u, u^1, \dots) := (f(x, u), u^1, u^2, \dots)$ . At the heart of our notion of equivalence are endogenous transformations, which map solutions of a system to solutions of another system. We single out here the important class of transformations mapping solutions of a system onto solutions of the *same* system:

**Definition 6.** *An endogenous transformation  $\Phi_g : \mathfrak{M} \mapsto \mathfrak{M}$  is a symmetry of the system  $(F, \mathfrak{M})$  if*

$$\forall \xi := (x, u, u^1, \dots) \in \mathfrak{M}, \quad F(\Phi_g(\xi)) = D\Phi_g(\xi) \cdot F(\xi).$$

More generally, we can consider a *symmetry group*, i.e., a collection  $(\Phi_g)_{g \in G}$  of symmetries such that  $\forall g_1, g_2 \in G, \Phi_{g_1} \circ \Phi_{g_2} = \Phi_{g_1 * g_2}$ , where  $(G, *)$  is a group.

Assume now the system is flat. The choice of a flat output is by no means unique, since any endogenous transformation on a flat output gives rise to another flat output.

**Example 15 (The kinematic car).** *The system generated by*

$$\dot{x} = u_1 \cos \theta, \quad \dot{y} = u_1 \sin \theta, \quad \dot{\theta} = u_2,$$

*admits the 3-parameter symmetry group of planar (orientation-preserving) isometries: for all translation  $(a, b)'$  and rotation  $\alpha$ , the endogenous mapping generated by*

$$\begin{aligned} X &= x \cos \alpha - y \sin \alpha + a \\ Y &= x \sin \alpha + y \cos \alpha + b \\ \Theta &= \theta + \alpha \\ U^1 &= u^1 \\ U^2 &= u^2 \end{aligned}$$

is a symmetry, since the state equations remain unchanged,

$$\dot{X} = U_1 \cos \Theta, \quad \dot{Y} = U_1 \sin \Theta, \quad \dot{\Theta} = U_2.$$

This system is flat  $z := (x, y)$  as a flat output. Of course, there are infinitely many other flat outputs, for instance  $\tilde{z} := (x, y + \dot{x})$ . Yet,  $z$  is obviously a more “natural” choice than  $\tilde{z}$ , because it “respects” the symmetries of the system. Indeed, each symmetry of the system induces a transformation on the flat output  $z$

$$\begin{pmatrix} z_1 \\ z_2 \end{pmatrix} \mapsto \begin{pmatrix} Z_1 \\ Z_2 \end{pmatrix} = \begin{pmatrix} X \\ Y \end{pmatrix} = \begin{pmatrix} z_1 \cos \alpha - z_2 \sin \alpha + a \\ z_1 \sin \alpha + z_2 \cos \alpha + b \end{pmatrix}$$

which does not involve derivatives of  $z$ , i.e., a point transformation. This point transformation generates an endogenous transformation  $(z, \dot{z}, \dots) \mapsto (Z, \dot{Z}, \dots)$ . Following [31], we say such an endogenous transformation which is the total prolongation of a point transformation is holonomic.

On the contrary, the induced transformation on  $\tilde{z}$

$$\begin{pmatrix} \tilde{z}_1 \\ \tilde{z}_2 \end{pmatrix} \mapsto \begin{pmatrix} \tilde{Z}_1 \\ \tilde{Z}_2 \end{pmatrix} = \begin{pmatrix} X \\ Y + \dot{X} \end{pmatrix} = \begin{pmatrix} \tilde{z}_1 \cos \alpha + (\dot{\tilde{z}}_1 - \tilde{z}_2) \sin \alpha + a \\ \tilde{z}_1 \sin \alpha + \tilde{z}_2 \cos \alpha + (\dot{\tilde{z}}_1 - \dot{\tilde{z}}_2) \sin \alpha + b \end{pmatrix}$$

is not a point transformation (it involves derivatives of  $\tilde{z}$ ) and does not give to a holonomic transformation.

Consider the system  $(F, \mathfrak{M})$  admitting a symmetry  $\Phi_g$  (or a symmetry group  $(\Phi_g)_{g \in G}$ ). Assume moreover the system is flat with  $h$  as a flat output and denotes by  $\Psi := (h, \dot{h}, \ddot{h}, \dots)$  the endogenous transformation generated by  $h$ . We then have:

**Definition 7 (Symmetry-preserving flat output).** *The flat output  $h$  preserves the symmetry  $\Phi_g$  if the composite transformation  $\Psi \circ \Phi_g \circ \Psi^{-1}$  is holonomic.*

This leads naturally to a fundamental question: assume a flat system admits the symmetry group  $(\Phi_g)_{g \in G}$ . Is there a flat output which preserves  $(\Phi_g)_{g \in G}$ ?

This question can in turn be seen as a special case of the following problem: view a dynamics  $\dot{x} - f(x, u) = 0$  as an *underdetermined differential system* and assume it admits a symmetry group; can it then be reduced to a “smaller” differential system? Whereas this problem has been studied for a long time and received a positive answer in the *determined* case, the underdetermined case seems to have been barely untouched [78]. Some connected question relative to invariant tracking are sketched in [99].

## 6.2 Flat outputs as potentials and gauge degree of freedom

Symmetries and the quest for potentials are at the heart of physics. To end the paper, we would like to show that flatness fits into this broader scheme.

Maxwell's equations in an empty medium imply that the magnetic field  $H$  is divergent free,  $\nabla \cdot H = 0$ . In Euclidian coordinates  $(x_1, x_2, x_3)$ , it gives the underdetermined partial differential equation

$$\frac{\partial H_1}{\partial x_1} + \frac{\partial H_2}{\partial x_2} + \frac{\partial H_3}{\partial x_3} = 0$$

A key observation is that the solutions to this equation derive from a vector potential  $H = \nabla \times A$ : the constraint  $\nabla \cdot H = 0$  is automatically satisfied whatever the potential  $A$ . This potential parameterizes all the solutions of the underdetermined system  $\nabla \cdot H = 0$ , see [89] for a general theory.  $A$  is a priori not uniquely defined, but up to an arbitrary gradient field, the gauge degree of freedom. The symmetries of the problem indicate how to use this degree of freedom to fix a “natural” potential.

The picture is similar for flat systems. A flat output is a “potential” for the underdetermined differential equation  $\dot{x} - f(x, u) = 0$ . Endogenous transformations on the flat output correspond to gauge degrees of freedom. The “natural” flat output is determined by symmetries of the system. Hence controllers designed from this flat output can also preserve the physics.

A slightly less esoteric way to convince the reader that flatness is an interesting notion is to take a look at the following small catalog of flat systems.

## 7 Catalogue of finite dimensional flat systems.

We give here a (partial) list of finite dimensional flat systems encountered in applications.

### 7.1 Holonomic mechanical systems

#### 7.1.1 Fully actuated holonomic systems

The dynamics of a holonomic system with as many independent inputs as configuration variables is

$$\frac{d}{dt} \left( \frac{\partial L}{\partial \dot{q}} \right) - \frac{\partial L}{\partial q} = M(q)u + D(q, \dot{q}),$$

with  $M(q)$  invertible. It admits  $q$  as a flat output –even when  $\frac{\partial^2 L}{\partial \dot{q}^2}$  is singular–: indeed,  $u$  can be expressed in function of  $q, \dot{q}$  by the *computed torque* formula

$$u = M(q)^{-1} \left( \frac{d}{dt} \left( \frac{\partial L}{\partial \dot{q}} \right) - \frac{\partial L}{\partial q} - D(q, \dot{q}) \right).$$

If  $q$  is constrained by  $c(q) = 0$  the system remains flat, and the flat output corresponds to the configuration point in  $c(q) = 0$ .

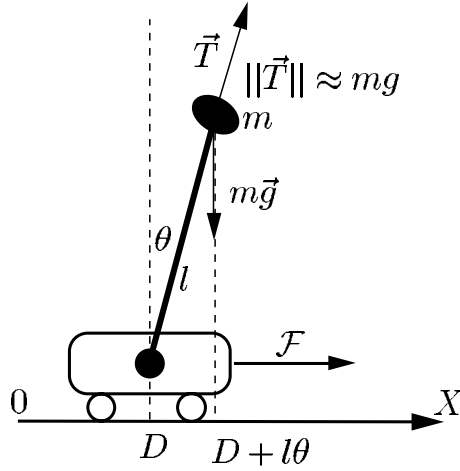

Figure 1: Inverted pendulum.

### 7.1.2 Linearized cart inverted pendulum

With small angle approximation, the dynamics reads:

$$\frac{d^2}{dt^2}(D + l\theta) = g\theta, \quad M \frac{d^2}{dt^2}D = -mg\theta + \mathcal{F}$$

where  $\mathcal{F}$ , the force applied to the trolley, is the control and  $l$  is the distance between the oscillation center and the rotation axis. The flat output is  $y = D + l\theta$ , the abscise of oscillation center. In fact,

$$\theta = \ddot{y}/g, \quad D = y - l\ddot{y}/g.$$

The high gain feedback ( $u$  as position set-point)

$$\mathcal{F} = -Mk_1\dot{D} - Mk_2(D - u)$$

with  $k_1 \approx 10/\tau$ ,  $k_2 \approx 10/\tau^2$  ( $\tau = \sqrt{l/g}$ ), yields the following slow dynamics:

$$\frac{d^2}{dt^2}(y) = g(y - u)/l = \frac{y - u}{\tau^2}.$$

The simple feedback

$$u = -y - \tau^2\ddot{y}_r(t) + \tau(\dot{y} - \dot{y}_r(t)) + (y - y_r(t))$$

ensure the tracking of  $t \mapsto y_r(t)$ .

This system is not feedback linearizable for large angle thus it is not flat (single input case).

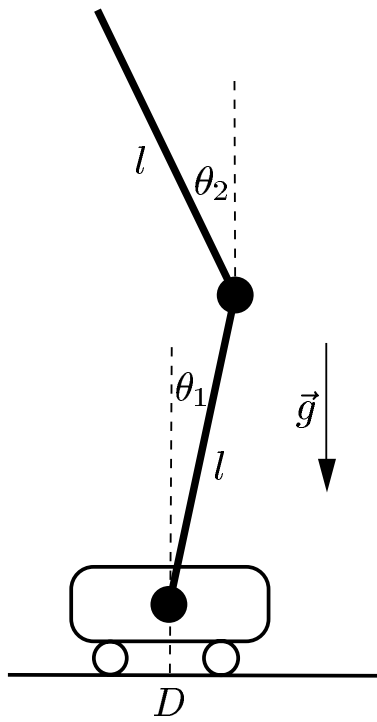

Figure 2: The double inverted pendulum.

### 7.1.3 The double inverted pendulum

Take two identical homogeneous beam over a trolley whose position  $D$  is directly controlled. Under small angle approximations, the dynamics reads

$$\begin{aligned}\theta_1 &= \frac{y^{(2)}}{g} - \frac{ly^{(4)}}{3g^2} \\ \theta_2 &= \frac{y^{(2)}}{g} + \frac{ly^{(4)}}{9g^2} \\ D &= y - \frac{35}{36}l\theta_1 - \frac{7}{12}l\theta_2 \\ &= y - \frac{14ly^{(2)}}{9g} + \frac{7l^2y^{(4)}}{27g^2}.\end{aligned}$$

where  $y$  is the flat output.

### 7.1.4 Planar rigid body with forces

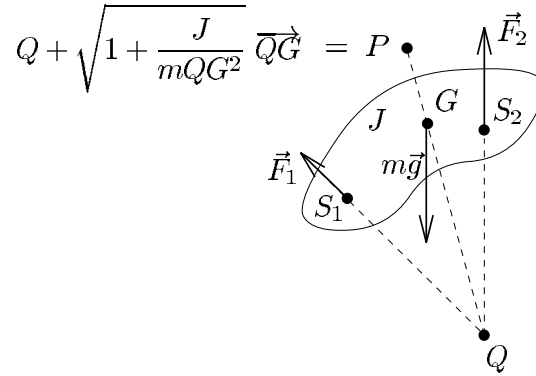

Figure 3: Planar rigid solid controlled by two body fixed forces.

Consider a planar rigid body moving in a vertical plane under the influence of gravity and controlled by two forces having lines of action that are fixed with respect to the body and intersect at a single point (see figure 3) (see [111]). The force are denoted by  $\vec{F}_1$  and  $\vec{F}_2$ . Their directions,  $\vec{e}_1$  and  $\vec{e}_2$ , are fixed with respect to the solid. These forces are applied at  $S_1$  and  $S_2$  points that are fixed with respect to the solid. We assume that these forces are independent, i.e., when  $S_1 = S_2$  their direction are not the same. We exclude the case  $S_1 = S_2 = G$  since the system is not controllable (kinetic momentum is invariant).

Set  $G$  the mass center and  $\theta$  the orientation of the solid. Denote by  $\vec{k}$  the unitary vector orthogonal to the plane.  $m$  is the mass and  $J$  the inertia with respect to the axis passing through  $G$  and of direction  $\vec{k}$ .  $\vec{g}$  is the gravity.

Dynamics read

$$\begin{aligned} m\ddot{G} &= \vec{F}_1 + \vec{F}_2 + m\vec{g} \\ J\ddot{\theta}\vec{k} &= \overrightarrow{GS}_1 \wedge \vec{F}_1 + \overrightarrow{GS}_2 \wedge \vec{F}_2. \end{aligned}$$

As shown on figure 3, flat output  $P$  is Huyghens oscillation center when the center of rotation is the intersection  $Q$  of the straight lines  $(S_1, \vec{e}_1)$  and  $(S_2, \vec{e}_2)$ :

$$P = Q + \sqrt{1 + \frac{J}{ma^2}} \overrightarrow{QG}.$$

with  $a = QG$ . Notice that when  $\vec{e}_1$  and  $\vec{e}_2$  are co-linear  $Q$  is sent to  $\infty$  and  $P$  coincides with  $G$ . Point  $P$  is the only point such that  $\ddot{P} - \vec{g}$  is colinear to the direction  $PG$ , i.e, gives  $\theta$ .

This example has some practical importance. The PVTOL system, the gantry crane and the robot  $2k\pi$  (see below) are of this form, as is the simplified *planar ducted fan* [75]. Variations of this example can be formed by changing the number and type of the inputs [71].

### 7.1.5 The rocket

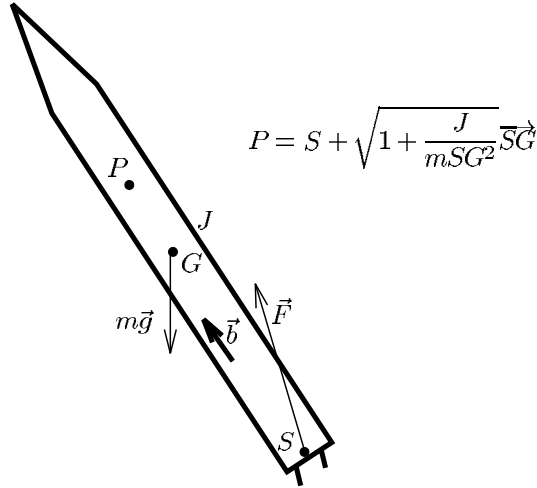

Figure 4: a rocket and its flat output  $P$ .

Other examples are possible in the 3-dimensional space with rigid body admitting symmetries. Take, e.g., the rocket of figure 4. Its equations are (no aero-dynamic forces)

$$\begin{aligned} m\ddot{G} &= \vec{F} + m\vec{g} \\ J \frac{d}{dt} (\vec{b} \wedge \dot{\vec{b}}) &= -\overrightarrow{SG} \wedge \vec{F} \end{aligned}$$



where  $\vec{b} = \overrightarrow{SG}/SG$  and

$$P = S + \sqrt{SG^2 + J/m} \vec{b}.$$

It is easy to see that  $\ddot{P} - \vec{g}$  is co-linear to the direction  $\vec{b}$ .

### 7.1.6 PVTOL aircraft

A simplified Vertical Take Off and Landing aircraft moving in a vertical Plane [34] can be described by

$$\begin{aligned}\ddot{x} &= -u_1 \sin \theta + \varepsilon u_2 \cos \theta \\ \ddot{z} &= u_1 \cos \theta + \varepsilon u_2 \sin \theta - 1 \\ \ddot{\theta} &= u_2.\end{aligned}$$

A flat output is  $y = (x - \varepsilon \sin \theta, z + \varepsilon \cos \theta)$ , see [58] more more details and a discussion in relation with unstable zero dynamics.

### 7.1.7 $2k\pi$ the juggling robot [47]

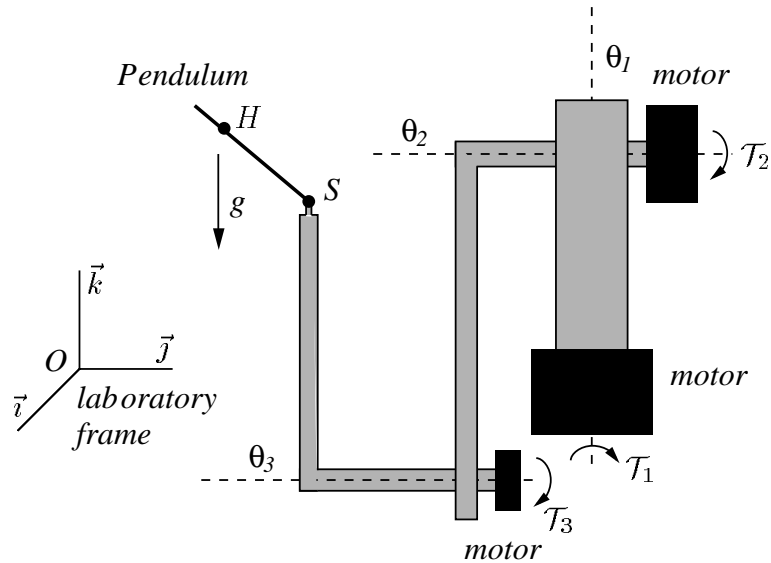

Figure 5: the robot  $2k\pi$ .

The robot  $2k\pi$  is developed at École des Mines de Paris and consists of a manipulator carrying a pendulum, see figure 5. There are five degrees of freedom (dof's): 3 angles for the manipulator and 2 angles for the pendulum. The 3 dof's of the manipulator are actuated by electric drives, while the 2 dof's of the pendulum are *not* actuated.

This system is typical of underactuated, nonlinear and unstable mechanical systems such as the PVTOL [57], Caltech's ducted fan [64, 59], the gantry crane [22], Champagne flyer [46]. As shown in [53, 22, 59] the robot  $2k\pi$  is flat, with the center of oscillation of the pendulum as a flat output. Let us recall some elementary facts

The cartesian coordinates of the suspension point  $S$  of the pendulum can be considered here as the control variables : they are related to the 3 angles of the manipulator  $\theta_1, \theta_2, \theta_3$  via static relations. Let us concentrated on the pendulum dynamics. This dynamics is similar to the ones of a punctual pendulum with the same mass  $m$  located at point  $H$ , the oscillation center (Huygens theorem). Denoting by  $l = \|SH\|$  the length of the isochronous punctual pendulum, Newton equation and geometric constraints yield the following differential-algebraic system ( $\vec{T}$  is the tension, see figure 6):

$$m\ddot{H} = \vec{T} + m\vec{g}, \quad S\vec{H} \wedge \vec{T} = 0, \quad \|SH\| = l.$$

If, instead of setting  $t \mapsto S(t)$ , we set  $t \mapsto H(t)$ , then  $\vec{T} = m(\ddot{H} - \vec{g})$ .  $S$  is located at the intersection of the sphere of center  $H$  and radius  $l$  with the line passing through  $H$  of direction  $\ddot{H} - \vec{g}$ :

$$S = H \pm \frac{l}{\|\ddot{H} - \vec{g}\|} (\ddot{H} - \vec{g}).$$

These formulas are crucial for designing a control law steering the pendulum from the lower equilibrium to the upper equilibrium, and also for stabilizing the pendulum while the manipulator is moving around [47].

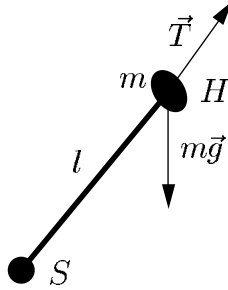

Figure 6: the isochronous pendulum.

### 7.1.8 Towed cable systems [70, 59]

This system consists of an aircraft flying in a circular pattern while towing a cable with a tow body (drogue) attached at the bottom. Under suitable conditions, the cable reaches a relative equilibrium in which the cable maintains its shape as it rotates. By choosing the parameters of the system appropriately, it is possible to make the radius at the bottom of the cable much smaller than the radius at the top of the cable. This is illustrated in Figure 7.

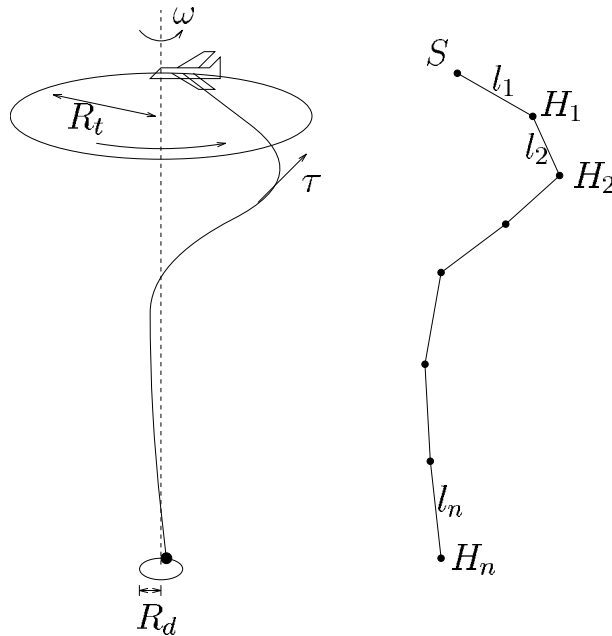

Figure 7: towed cable system and finite link approximate model.

The motion of the towed cable system can be approximately represented using a finite element model in which segments of the cable are replaced by rigid links connected by spherical joints. The forces acting on the segment (tension, aerodynamic drag and gravity) are lumped and applied at the end of each rigid link. In addition to the forces on the cable, we must also consider the forces on the drogue and the towplane. The drogue is modeled as a sphere and essentially acts as a mass attached to the last link of the cable, so that the forces acting on it are included in the cable dynamics. The external forces on the drogue again consist of gravity and aerodynamic drag. The towplane is attached to the top of the cable and is subject to drag, gravity, and the force of the attached cable. For simplicity, we simply model the towplane as a pure force applied at the top of the cable. Our goal is to generate trajectories for this system that allow operation away from relative equilibria as well as transition between one equilibrium point and another. Due to the high dimension of the model for the system (128 states is typical), traditional approaches to solving this problem, such as optimal control theory, cannot be easily applied. However, it can be shown that this system is differentially flat using the position of the bottom of the cable  $H_n$  as the differentially flat output. See [70] for a more complete description and additional references.

Assume no friction and only gravity. Then, as for the pendulum of  $2k\pi$ , we

have

$$H_{n-1} = H_n + \frac{1}{\|m_n \ddot{H}_n - m_n \vec{g}\|} (m_n \ddot{H}_n - m_n \vec{g})$$

where  $m_n$  is the mass of link  $n$ . Newton equation for link  $n - 1$  yields (with obvious notations)

$$H_{n-2} = H_{n-1} + \frac{(m_n \ddot{H}_n + m_{n-1} \ddot{H}_{n-1} - (m_n + m_{n-1}) \vec{g})}{\|m_n \ddot{H}_n + m_{n-1} \ddot{H}_{n-1} - (m_n + m_{n-1}) \vec{g}\|}.$$

More generally, we have at link  $i$

$$H_{i-1} = H_i + \frac{1}{\|\sum_i^n m_k (\ddot{H}_k - \vec{g})\|} \left( \sum_i^n m_k (\ddot{H}_k - \vec{g}) \right).$$

These relations imply that  $S$  is function of  $H_n$  and its time derivatives up to order  $2n$ . Thus  $H_n$  is the flat output.

### 7.1.9 Gantry crane [22, 51, 49]

A direct application of Newton's laws provides the implicit equations of motion

$$\begin{aligned} m\ddot{x} &= -T \sin \theta & x &= R \sin \theta + D \\ m\ddot{z} &= -T \cos \theta + mg & z &= R \cos \theta, \end{aligned}$$

where  $x, z, \theta$  are the configuration variables and  $T$  is the tension in the cable. The control inputs are the trolley position  $D$  and the cable length  $R$ . This system is flat, with the position  $(x, z)$  of the load as a flat output.

### 7.1.10 Conventional aircraft

A conventional aircraft is flat, provided some small aerodynamic effects are neglected, with the coordinates of the center of mass and side-slip angle as a flat output. See [53] for a detailed study.

### 7.1.11 Satellite with two controls

We end this section with a system which is not known to be flat for generic parameter value but still enjoys the weaker property of being *orbitally* flat [20]. Consider with [6] a satellite with two control inputs  $u_1, u_2$  described by

$$\begin{aligned} \dot{\omega}_1 &= u_1 \\ \dot{\omega}_2 &= u_2 \\ \dot{\omega}_3 &= a\omega_1\omega_2 \\ \dot{\varphi} &= \omega_1 \cos \theta + \omega_3 \sin \theta \\ \dot{\theta} &= (\omega_1 \sin \theta - \omega_3 \cos \theta) \tan \varphi + \omega_2 \\ \dot{\psi} &= \frac{(\omega_3 \cos \theta - \omega_1 \sin \theta)}{\cos \varphi}, \end{aligned} \tag{24}$$

where  $a = (J_1 - J_2)/J_3$  ( $J_i$  are the principal moments of inertia); physical sense imposes  $|a| \leq 1$ . Eliminating  $u_1, u_2$  and  $\omega_1, \omega_2$  by

$$\omega_1 = \frac{\dot{\varphi} - \omega_3 \sin \theta}{\cos \theta} \quad \text{and} \quad \omega_2 = \dot{\theta} + \dot{\psi} \sin \varphi$$

yields the equivalent system

$$\dot{\omega}_3 = a(\dot{\theta} + \dot{\psi} \sin \varphi) \frac{\dot{\varphi} - \omega_3 \sin \theta}{\cos \theta} \quad (25)$$

$$\dot{\psi} = \frac{\omega_3 - \dot{\varphi} \sin \theta}{\cos \varphi \cos \theta}. \quad (26)$$

But this system is in turn equivalent to

$$\begin{aligned} \cos \theta (\ddot{\psi} \cos \varphi - (1+a)\dot{\psi}\dot{\varphi} \sin \varphi) + \sin \theta (\ddot{\varphi} + a\dot{\psi}^2 \sin \varphi \cos \varphi) \\ + \dot{\theta}(1-a)(\dot{\varphi} \cos \theta - \dot{\psi} \sin \theta \cos \varphi) = 0 \end{aligned}$$

by substituting  $\omega_3 = \dot{\psi} \cos \varphi \cos \theta + \dot{\varphi} \sin \theta$  in (25).

When  $a = 1$ ,  $\theta$  can clearly be expressed in function of  $\varphi, \psi$  and their derivatives. We have proved that (24) is flat with  $(\varphi, \psi)$  as a flat output. A similar calculation can be performed when  $a = -1$ .

## 7.2 Nonholonomic mechanical systems

Many mobile robots such as considered in [7, 73, 108] admit the same structure. They are flat and the flat output corresponds to the Cartesian coordinates of a special point. Starting from the classical  $n$ -trailer systems [98, 22, 97, 18] we show that, when  $n$ , the number of trailers, tends to infinity the system tends to a trivial delay system, the non-holonomic snake. Invariance with respect to rotations and translations make very natural the use of Frénet formulae and curve parameterization with respect to arc length instead of time (see [59, 99] for relations between flatness and physical symmetries). The study of such systems gives us the opportunity to recall links with an old problem stated by Hilbert [35] and investigated by Cartan [8], on Pfaffian systems, Goursat normal forms and (absolute) equivalence.

### 7.2.1 The car

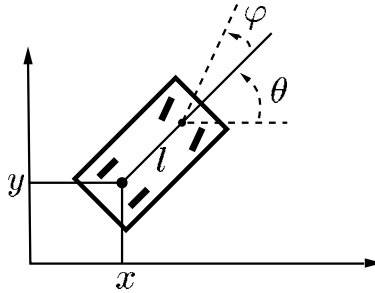

Figure 8: kinematic of a car.

The rolling without slipping conditions yield (see figure 8 for the notations)

$$\begin{cases} \dot{x} &= v \cos \theta \\ \dot{y} &= v \sin \theta \\ \dot{\theta} &= \frac{v}{l} \tan \varphi \end{cases} \quad (27)$$

where  $v$ , the velocity, and  $\varphi$ , the steering angle are the two controls. These equations mean geometrically that the angle  $\theta$  gives the direction of the tangent to the curve followed by  $P$ , the point of coordinates  $(x, y)$ , and that  $\tan \varphi/l$  corresponds to the curvature of this curve:

$$v = \pm \|\dot{P}\|, \quad \begin{pmatrix} \cos \theta \\ \sin \theta \end{pmatrix} = \dot{P}/v, \quad \tan \varphi = l \det(\ddot{P}\dot{P})/v\sqrt{|v|}.$$

There is thus a one to one correspondence between arbitrary smooth curves and the solutions of (27). It provides, as shown in [22], a very simple algorithm to steer the car from one configuration to another one.

### 7.2.2 Car with $n$ -trailers [22]

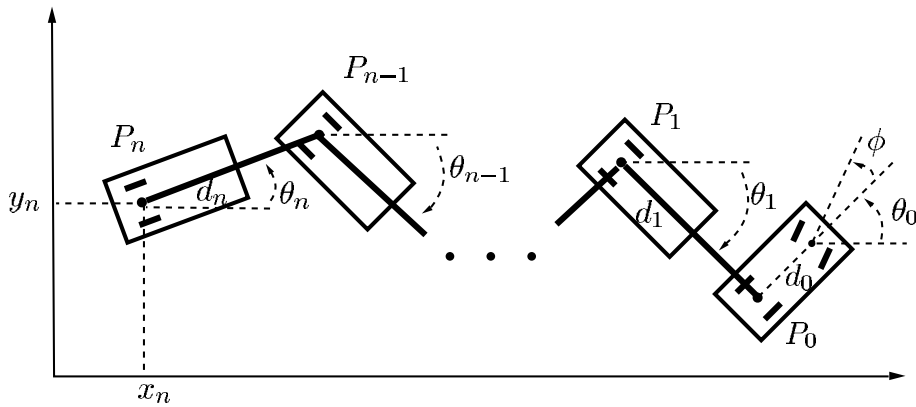

Figure 9: car with  $n$  trailers.

Take the single car here above and hitch, as display on figure 9,  $n$  trailers. The resulting system still admits two control: the velocity of the car  $v$  and the steering angle  $\phi$ . As for the single car, modelling is based on the rolling without slipping conditions.

There is a one to one correspondence between smooth curves of arbitrary shapes and the system trajectories. It suffices to consider the curve followed by  $P_n$ , the cartesian position of the last trailer. It is not necessary to write down explicitly the system equations in the state-space form as (27). Just remember that the kinematic constraints say that the velocity of each trailer (more precisely of the middle of its wheel axle) is parallel to the direction of its hitch.

Take  $n = 1$  and have a look at figure 10. Assume that the curve  $\mathcal{C}$  followed by  $P_1$  is smooth. Take  $s \rightarrow P(s)$  an arc length parameterization. Then  $P_1 = P(s)$ ,  $\theta_1$  is the angle of  $\vec{\tau}$ , the unitary tangent vector to  $\mathcal{C}$ . Since  $P_0 = P + d_1\vec{\tau}$  derivation with respect to  $s$  provides

$$\frac{d}{ds}P_0 = \vec{\tau} + d_1\kappa\vec{\nu}$$

with  $(\vec{\tau}, \vec{\nu})$  the Frénet frame of  $\mathcal{C}$  and  $\kappa$  its curvature. Thus  $\frac{d}{ds}P_0 \neq 0$  is tangent to

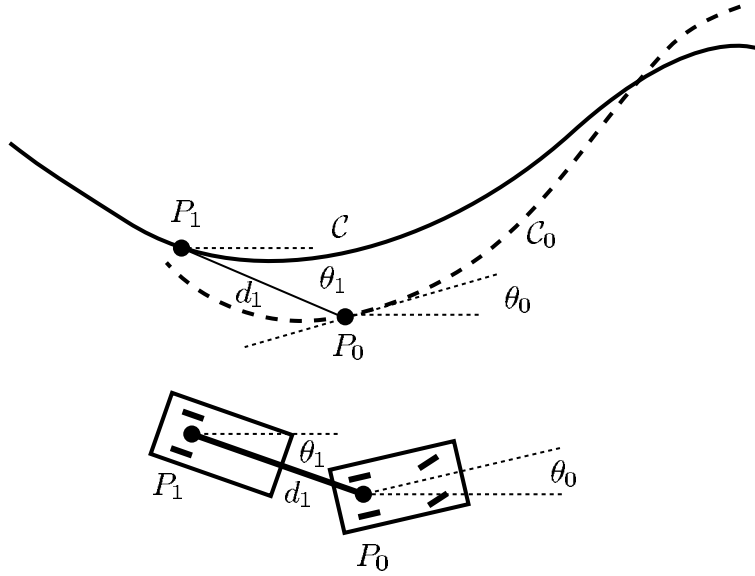

Figure 10: case  $n = 1$ .

$C_0$ , the curve followed by  $P_0$ . This curve is necessary smooth and

$$\tan(\theta_0 - \theta_1) = d_1 \kappa, \quad \vec{\tau}_0 = \frac{1}{\sqrt{1 + (d_1 \kappa)^2}} (\vec{\tau} + d_1 \kappa \vec{\nu}).$$

Derivation with respect to  $s_0$ , ( $ds_0 = \sqrt{1 + (d_1 \kappa)^2} ds$ ) yields the steering angle  $\phi$  :

$$\tan \phi = d_0 \kappa_0 = d_0 \frac{1}{\sqrt{1 + (d_1 \kappa)^2}} \left( \kappa + \frac{d_1}{1 + (d_1 \kappa)^2} \frac{d\kappa}{ds} \right).$$

The car velocity  $v$  is then given by

$$v(t) = \sqrt{1 + d_1^2 \kappa^2(s(t))} \dot{s}(t)$$

for any  $C^1$  time function,  $t \rightarrow s(t)$ . Notice that  $\phi$  and  $\theta_0 - \theta_1$  always remain in  $] -\pi/2, \pi/2[$ . These computations prove the one to one correspondence between the system trajectories respecting  $\phi$  and  $\theta_0 - \theta_1$  in  $] -\pi/2, \pi/2[$ , and regular planar curves of arbitrary shape with an arbitrary  $C^1$  time parameterization.

The case  $n > 1$  is just a direct generalization. The correspondence between arbitrary smooth curves  $s \mapsto P(s)$  (tangent  $\vec{\tau}$ , curvature  $\kappa$ ) with a  $C^1$  time parameterization  $t \mapsto s(t)$  is then defined by a smooth invertible map

$$\begin{aligned} \mathbb{R}^2 \times \mathbb{S}^1 \times \mathbb{R}^{n+2} &\mapsto \mathbb{R}^2 \times \mathbb{S}^1 \times ] -\pi/2, \pi/2[^{n+1} \times \mathbb{R} \\ \left( P, \vec{\tau}, \kappa, \frac{d\kappa}{ds}, \dots, \frac{d^n \kappa}{ds^n}, \dot{s} \right) &\mapsto (P_n, \theta_n, \theta_n - \theta_{n-1}, \dots, \theta_1 - \theta_0, \phi, v) \end{aligned}$$

where  $v$  is the car velocity. More details are given in [22].

With such a correspondence, motion planning reduces to a trivial problem: to find a smooth curve with prescribed initial and final positions, tangents, curvatures  $\kappa$  and curvature derivatives,  $d^i \kappa / ds^i$ ,  $i = 1, \dots, n$ .

### 7.2.3 The general one-trailer system [98]

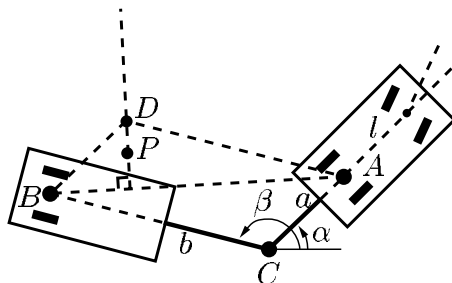

Figure 11: car with one trailer.

This nonholonomic system is displayed on figure 11: here the trailer is not directly hitched to the car at the center of the rear axle, but more realistically at a distance  $a$  of this point. The equations are

$$\begin{cases} \dot{x} = \cos \alpha v \\ \dot{y} = \sin \alpha v \\ \dot{\alpha} = \frac{1}{l} \tan \varphi v \\ \dot{\beta} = \frac{1}{b} \left( \frac{a}{l} \tan \varphi \cos(\alpha - \beta) - \sin(\alpha - \beta) \right) v. \end{cases} \quad (28)$$

Controls are the car velocity  $v$  and the steering angle  $\varphi$ .

There still exists a one to one correspondence between the trajectories of (28) and arbitrary smooth curves with a  $C^1$  time parameterization. Such curves are followed by the point  $P$  (see figure 11) of coordinates

$$\begin{aligned} X &= x + b \cos \beta + L(\alpha - \beta) \frac{b \sin \beta - a \sin \alpha}{\sqrt{a^2 + b^2 - 2ab \cos(\alpha - \beta)}} \\ Y &= y + b \sin \beta + L(\alpha - \beta) \frac{a \cos \alpha - b \cos \beta}{\sqrt{a^2 + b^2 - 2ab \cos(\alpha - \beta)}} \end{aligned} \quad (29)$$

where  $L$  is defined by an elliptic integral :

$$L(\alpha - \beta) = ab \int_{\pi}^{2\pi + \alpha - \beta} \frac{\cos \sigma}{\sqrt{a^2 + b^2 - 2ab \cos \sigma}} d\sigma. \quad (30)$$

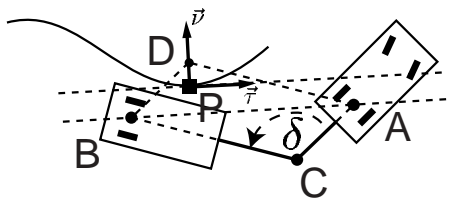

Figure 12: geometric construction with the Frénet frame.



We have also a geometrical construction (see figure 12): the tangent vector  $\vec{\tau}$  is parallel to  $AB$ . Its curvature  $\kappa$  depends on  $\delta = \alpha - \beta$ :

$$\kappa = K(\delta) = \frac{\sin \delta}{\cos \delta \sqrt{a^2 + b^2 - 2ab \cos \delta} - L(\delta) \sin \delta} \quad (31)$$

Function  $K$  is an increasing bijection between  $]\gamma, 2\pi - \gamma[$  and  $\mathbb{R}$ . The constant  $\gamma \in [0, \pi/2]$  is defined by the implicit equation

$$\cos \gamma \sqrt{a^2 + b^2 - 2ab \cos \gamma} = ab \sin \gamma \int_{\pi}^{\gamma} \frac{\cos \sigma}{\sqrt{a^2 + b^2 - 2ab \cos \sigma}} d\sigma.$$

For  $a = 0$ ,  $\gamma = \pi/2$  and  $P$  coincides with  $B$ . Then  $D$  is given by  $D = P - L(\delta)\vec{\nu}$  with  $\vec{\nu}$  the unitary normal vector. Thus  $(x, y, \alpha, \beta)$  depends on  $(P, \vec{\tau}, \kappa)$ . The steering angle  $\varphi$  depends on  $\kappa$  and  $d\kappa/ds$  where  $s$  is the arc length. Car velocity  $v$  is then computed from  $\kappa$ ,  $d\kappa/ds$  and  $\dot{s}$ , the velocity of  $P$ .

#### 7.2.4 The rolling penny

The dynamics of this Lagrangian system submitted to a nonholonomic constraint is described by

$$\begin{aligned} \ddot{x} &= \lambda \sin \varphi + u_1 \cos \varphi \\ \ddot{y} &= -\lambda \cos \varphi + u_1 \sin \varphi \\ \ddot{\varphi} &= u_2 \\ \dot{x} \sin \varphi &= \dot{y} \cos \varphi \end{aligned}$$

where  $x, y, \varphi$  are the configuration variables,  $\lambda$  is the Lagrange multiplier of the constraint and  $u_1, u_2$  are the control inputs. A flat output is  $(x, y)$ : indeed, parameterizing time by the arclength  $s$  of the curve  $t \mapsto (x(t), y(t))$  we find

$$\cos \varphi = \frac{dx}{ds}, \quad \sin \varphi = \frac{dy}{ds}, \quad u_1 = \dot{s}, \quad u_2 = \kappa(s) \ddot{s} + \frac{d\kappa}{ds} \dot{s}^2,$$

where  $\kappa$  is the curvature. These formulas remain valid even if  $u_1 = u_2 = 0$ .

This example can be generalized to any mechanical system subject to  $m$  flat nonholonomic constraints, provided there are  $n - m$  control forces independent of the constraint forces ( $n$  the number of configuration variables), i.e., a “fully-actuated” nonholonomic system as in [7].

#### 7.2.5 Kinematics generated by *two* nonholonomic constraints

Such systems are flat by theorem 5 since they correspond to driftless systems with  $n$  states and  $n - 2$  inputs. For instance the rolling disc (p. 4), the rolling sphere (p. 96) and the bicycle (p. 330) considered in the classical treatise on nonholonomic mechanics [74] are flat.

All these flat nonholonomic systems have a controllability singularity at rest. Yet, it is possible to “blow up” the singularity by reparameterizing time with the arclength of the curve described by the flat output, hence to plan and track trajectories starting from and stopping at rest as explained in [22, 98, 18].

## 7.3 Electromechanical systems

### 7.3.1 DC-to-DC converter

A Pulse Width Modulation DC-to-DC converter can be modeled by

$$\dot{x}_1 = (u - 1)\frac{x_2}{L} + \frac{E}{L}, \quad \dot{x}_2 = (1 - u)\frac{x_1}{LC} - \frac{x_2}{RC},$$

where the duty ratio  $u \in [0, 1]$  is the control input. The electrical stored energy  $y := \frac{x_1^2}{2C} + \frac{x_2^2}{2L}$  is a flat output [103, 39].

### 7.3.2 Magnetic bearings

A simple flatness-based solution to motion planning and tracking is proposed in [50]. The control law ensures that only one electromagnet in each actuator works at a time and permits to reduce the number of electromagnets by a better placement of actuators.

### 7.3.3 Induction motor

The standard two-phase model of the induction motor reads in complex notation (see [48] for a complete derivation)

$$\begin{aligned} R_s i_s + \dot{\psi}_s &= u_s & \psi_s &= L_s i_s + M e^{jn\theta} i_r \\ R_r i_r + \dot{\psi}_r &= 0 & \psi_r &= M e^{-jn\theta} i_s + L_r i_r, \end{aligned}$$

where  $\psi_s$  and  $i_s$  (resp.  $\psi_r$  and  $i_r$ ) are the complex stator (resp. rotor) flux and current,  $\theta$  is the rotor position and  $j = \sqrt{-1}$ . The control input is the voltage  $u_s$  applied to the stator. Setting  $\psi_r = \rho e^{j\alpha}$ , the rotor motion is described by

$$J \frac{d^2\theta}{dt^2} = \frac{n}{R_r} \rho^2 \dot{\alpha} - \tau_L(\theta, \dot{\theta}),$$

where  $\tau_L$  is the load torque.

This system is flat with the two angles  $(\theta, \alpha)$  as a flat output [63] (see [11] also for a related result).

## 7.4 Chemical systems

### 7.4.1 CSTRs

Many simple models of Continuous Stirred Tank Reactors (CSTRs) admit flats outputs with a direct physical interpretation in terms of temperatures or product concentrations [36, 1], as do closely related biochemical processes [4, 17]. In [95] flatness is used to steer a reactor model from a steady state to another one while respecting some physical constraints. In [67], flatness based control of nonlinear delay chemical reactors is proposed.

A basic model of a CSTR with *two* chemical species and any number of exothermic or endothermic reactions is

$$\begin{aligned} \dot{x}_1 &= f_1(x_1, x_2) + g_1(x_1, x_2)u \\ \dot{x}_2 &= f_2(x_1, x_2) + g_2(x_1, x_2)u, \end{aligned}$$

where  $x_1$  is a concentration,  $x_2$  a temperature and  $u$  the control input (feedflow or heat exchange). It is obviously linearizable by static feedback, hence flat.

When more chemical species are involved, a single-input CSTR is in general not flat, see [40]. Yet, the addition of another manipulated variable often renders it flat, see [1] for an example on a free-radical polymerization CSTR. For instance basic model of a CSTR with *three* chemical species, any number of exothermic or and two control inputs is

$$\begin{aligned}\dot{x}_1 &= f_1(x) + g_1^1(x)u_1 + g_1^2(x)u_2 \\ \dot{x}_2 &= f_2(x) + g_2^1(x)u_1 + g_2^2(x)u_2 \\ \dot{x}_3 &= f_3(x) + g_3^1(x)u_1 + g_3^2(x)u_2,\end{aligned}$$

where  $x_1, x_2$  are concentrations and  $x_3$  is a temperature and  $u_1, u_2$  are the control inputs (feed-flow, heat exchange, feed-composition, . . .). Such a system is always flat, see section 4.2.3.

#### 7.4.2 heating system

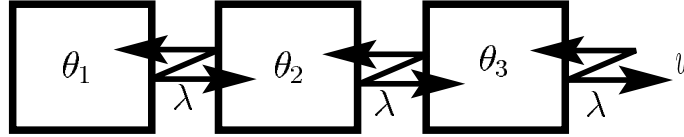

Figure 13: a finite volume model of a heating system.

Consider the 3-compartment model described on figure 13. Its dynamics is based on the following energy balance equations ( $(m, \rho, C_p, \lambda)$  are physical constants)

$$\begin{cases} m\rho C_p \dot{\theta}_1 = \lambda(\theta_2 - \theta_1) \\ m\rho C_p \dot{\theta}_2 = \lambda(\theta_1 - \theta_2) + \lambda(\theta_3 - \theta_2) \\ m\rho C_p \dot{\theta}_3 = \lambda(\theta_2 - \theta_3) + \lambda(u - \theta_3). \end{cases} \quad (32)$$

Its is obvious that this linear system is controllable with  $y = \theta_1$  as Brunovsky output: it can be transformed via linear change of coordinates and linear static feedback into  $y^{(3)} = v$ .

Taking an arbitrary number  $n$  of compartments yields

$$\begin{cases} m\rho C_p \dot{\theta}_1 = \lambda(\theta_2 - \theta_1) \\ m\rho C_p \dot{\theta}_2 = \lambda(\theta_1 - \theta_2) + \lambda(\theta_3 - \theta_2) \\ \vdots \\ m\rho C_p \dot{\theta}_i = \lambda(\theta_{i-1} - \theta_i) + \lambda(\theta_{i+1} - \theta_i) \\ \vdots \\ m\rho C_p \dot{\theta}_{n-1} = \lambda(\theta_{n-2} - \theta_{n-1}) + \lambda(\theta_n - \theta_{n-1}) \\ m\rho C_p \dot{\theta}_n = \lambda(\theta_{n-1} - \theta_n) + \lambda(u - \theta_n). \end{cases} \quad (33)$$

$y = \theta_1$  remains the Brunovsky output: via linear change of coordinates and linear static feedback we have  $y^{(n)} = v$ .

When  $n$  tends to infinity,  $m$  and  $\lambda$  tend to zeros as  $1/n$  and (33) tends to the classical heat equation where the temperature on the opposite side to  $u$ , i.e.,  $y = \theta(0, t)$ , still plays a special role.

### 7.4.3 Polymerization reactor

Consider with [106] the reactor

$$\begin{aligned}\dot{C}_m &= \frac{C_{m_{m_s}}}{\tau} - \left(1 + \bar{\varepsilon} \frac{\mu_1}{\mu_1 + M_m C_m}\right) \frac{C_m}{\tau} + R_m(C_m, C_i, C_s, T) \\ \dot{C}_i &= -k_i(T)C_i + u_2 \frac{C_{i_{i_s}}}{V} - \left(1 + \bar{\varepsilon} \frac{\mu_1}{\mu_1 + M_m C_m}\right) \frac{C_i}{\tau} \\ \dot{C}_s &= u_2 \frac{C_{s_{i_s}}}{V} + \frac{C_{s_{m_s}}}{\tau} - \left(1 + \bar{\varepsilon} \frac{\mu_1}{\mu_1 + M_m C_m}\right) \frac{C_s}{\tau} \\ \dot{\mu}_1 &= -M_m R_m(C_m, C_i, C_s, T) - \left(1 + \bar{\varepsilon} \frac{\mu_1}{\mu_1 + M_m C_m}\right) \frac{\mu_1}{\tau} \\ \dot{T} &= \phi(C_m, C_i, C_s, \mu_1, T) + \alpha_1 T_j \\ \dot{T}_j &= f_6(T, T_j) + \alpha_4 u_1,\end{aligned}$$

where  $u_1, u_2$  are the control inputs and  $C_{m_{m_s}}, M_m, \bar{\varepsilon}, \tau, C_{i_{i_s}}, C_{s_{m_s}}, C_{s_{i_s}}, V, \alpha_1, \alpha_4$  are constant parameters. The functions  $R_m, k_i, \phi$  and  $f_6$  are not well-known and derive from experimental data and semi-empirical considerations, involving kinetic laws, heat transfer coefficients and reaction enthalpies.

The polymerization reactor is flat whatever the functions  $R_m, k_i, \phi, f_6$  and admits  $(C_{s_{i_s}} C_i - C_{i_{i_s}} C_s, M_m C_m + \mu_1)$  as a flat output [96].

## 8 Infinite dimension “flat” systems

The idea underlying equivalence and flatness –a one-to-one correspondence between trajectories of systems– is not restricted to control systems described by *ordinary* differential equations. It can be adapted to delay differential systems and to partial differential equations with boundary control. Of course, there are many more technicalities and the picture is far from clear. Nevertheless, this new point of view seems promising for the design of control laws. In this section, we sketch some recent developments in this direction.

### 8.1 Delay systems

Consider for instance the simple differential delay system

$$\dot{x}_1(t) = x_2(t), \quad \dot{x}_2(t) = x_1(t) - x_2(t) + u(t-1).$$

Setting  $y(t) := x_1(t)$ , we can clearly explicitly parameterize its trajectories by

$$x_1(t) = y(t), \quad x_2(t) = \dot{y}(t), \quad u(t) = \ddot{y}(t+1) + \dot{y}(t+1) - y(t+1).$$

In other words,  $y(t) := x_1(t)$  plays the role of a “flat” output. This idea is investigated in detail in [66], where the class of  $\delta$ -free systems is defined ( $\delta$  is the delay operator). More precisely, [66, 68] considers linear differential delay systems

$$M(d/dt, \delta)w = 0$$

where  $M$  is a  $(n - m) \times n$  matrix with entries polynomials in  $d/dt$  and  $\delta$  and  $w = (w_1, \dots, w_n)$  are the system variables. Such a system is said to be  $\delta$ -free if it can be related to the “free” system  $y = (y_1, \dots, y_m)$  consisting of arbitrary functions of time by

$$\begin{aligned} w &= P(d/dt, \delta, \delta^{-1})y \\ y &= Q(d/dt, \delta, \delta^{-1})w, \end{aligned}$$

where  $P$  (resp.  $Q$ ) is a  $n \times m$  (resp.  $m \times n$ ) matrix the entries of which are polynomial in  $d/dt$ ,  $\delta$  and  $\delta^{-1}$ .

Many linear delay systems are  $\delta$ -free. For example,  $\dot{x}(t) = Ax(t) + Bu(t - 1)$ ,  $(A, B)$  controllable, is  $\delta$ -free, with the Brunovski output of  $\dot{x} = Ax + Bv$  as a “ $\delta$ -free” output.

The following systems, commonly used in process control,

$$z_i(s) = \sum_{j=1}^m \left\{ \frac{K_i^j \exp(-s\delta_i^j)}{1 + \tau_i^j s} \right\} u_j(s), \quad i = 1, \dots, p$$

( $s$  Laplace variable, gains  $K_i^j$ , delays  $\delta_i^j$  and time constants  $\tau_i^j$  between  $u_j$  and  $z_i$ ) are  $\delta$ -free [79]. Other interesting examples of  $\delta$ -free systems arise from partial differential equations:

**Example 16 (Torsion beam system).** *The torsion motion of a beam (figure 14) can be modeled in the linear elastic domain by*

$$\begin{aligned} \partial_t^2 \theta(x, t) &= \partial_x^2 \theta(x, t), \quad x \in [0, 1] \\ \partial_x \theta(0, t) &= u(t) \\ \partial_x \theta(1, t) &= \partial_t^2 \theta(1, t), \end{aligned}$$

where  $\theta(x, t)$  is the torsion of the beam and  $u(t)$  the control input. From d’Alembert’s formula,  $\theta(x, t) = \phi(x + t) + \psi(x - t)$ , we easily deduce

$$\begin{aligned} 2\theta(t, x) &= \dot{y}(t + x - 1) - \dot{y}(t - x + 1) + y(t + x - 1) + y(t - x + 1) \\ 2u(t) &= \ddot{y}(t + 1) + \ddot{y}(t - 1) - \dot{y}(t + 1) + \dot{y}(t - 1), \end{aligned}$$

where we have set  $y(t) := \theta(1, t)$ . This proves the system is  $\delta$ -free with  $\theta(1, t)$  as a “ $\delta$ -flat” output. See [69, 27, 30] for details and an application to motion planning.

Many examples of delay systems derived from the 1D-wave equation can be treated via such techniques (see [16] for tank filled with liquid, [26] for the telegraph equation and [80] for two physical examples with delay depending on control).

The following example shows that explicit parameterization via distributed delay operators can also be useful. Small angle approximation of an homogenous heavy chain yields the following dynamics around the stable vertical steady-state:

$$\begin{cases} \frac{\partial}{\partial s} (gs \frac{\partial X}{\partial s}) - \frac{\partial^2 X}{\partial t^2} = 0 \\ X(L, t) = u(t). \end{cases} \quad (34)$$

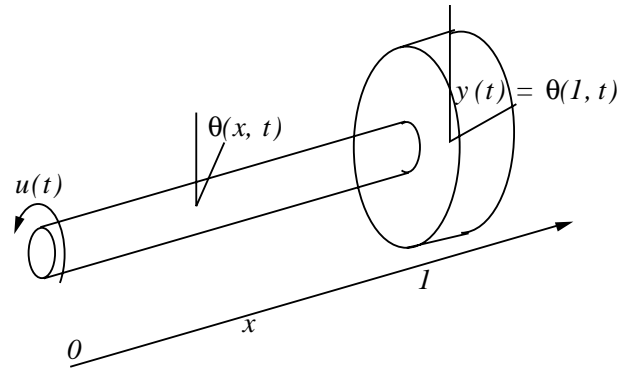

Figure 14: torsion of a flexible beam

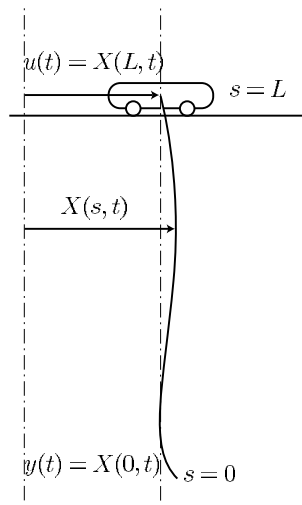

Figure 15: the homogeneous chain without any load.

where  $X(s, t)$  is the horizontal position of the chain element indexed by  $s \in [0, L]$ . The control  $u$  is the trolley horizontal position.

We prove in [84] that the general solution of (34) is given by the following formulas where  $y$  is the free end position  $X(0, t)$  :

$$X(s, t) = \frac{1}{2\pi} \int_{-\pi}^{\pi} y(t + 2\sqrt{s/g} \sin \theta) d\theta. \quad (35)$$

Simple computations show that (35) corresponds to the series solution of the (singular) Cauchy-Kovalesky problem:

$$\begin{cases} \frac{\partial}{\partial s} (gs \frac{\partial X}{\partial s}) = \frac{\partial^2 X}{\partial t^2} \\ X(0, t) = y(t). \end{cases}$$

Relation (35) means that there is a one to one correspondence between the (smooth) solutions of (34) and the (smooth) functions  $t \mapsto y(t)$ . For each solution of (34), set  $y(t) = X(0, t)$ . For each function  $t \mapsto y(t)$ , set  $X$  via (35) and  $u$  via

$$u(t) = \frac{1}{2\pi} \int_{-\pi}^{\pi} y(t + 2\sqrt{L/g} \sin \theta) d\theta \quad (36)$$

to obtain a solution of (34).

Finding  $t \mapsto u(t)$  steering the system from a steady-state  $X \equiv 0$  to another one  $X \equiv D$  becomes obvious. It just consists in finding  $t \mapsto y(t)$  that is equal to 0 for  $t \leq 0$  and to  $D$  for  $t$  large enough (at least for  $t > 4\sqrt{L/g}$ ) and in computing  $u$  via (36).

For example take

$$y(t) = \begin{cases} 0 & \text{if } t < 0 \\ \frac{3L}{2} \left(\frac{t}{T}\right)^2 \left(3 - 2\left(\frac{t}{T}\right)\right) & \text{if } 0 \leq t \leq T \\ \frac{3L}{2} & \text{if } t > T \end{cases}$$

where the chosen transfer time  $T$  equals  $2\Delta$  with  $\Delta = 2\sqrt{L/g}$ , the travelling time of a wave between  $x = L$  and  $x = 0$ . For  $t \leq 0$  the chain is vertical at position 0. For  $t \geq T$  the chain is vertical at position  $D = 3L/2$ .

## 8.2 Distributed parameters systems

For partial differential equations with boundary control and mixed systems of partial and ordinary differential equations, it seems possible to describe the one-to-one correspondence via series expansion, though a sound theoretical framework is yet to be found. We illustrate this original approach to control design on the following two “flat” systems.

**Example 17 (Heat equation).** Consider as in [45] the linear heat equation

$$\partial_t \theta(x, t) = \partial_x^2 \theta(x, t), \quad x \in [0, 1] \quad (37)$$

$$\partial_x \theta(0, t) = 0 \quad (38)$$

$$\theta(1, t) = u(t), \quad (39)$$

where  $\theta(x, t)$  is the temperature and  $u(t)$  is the control input.

We claim that

$$y(t) := \theta(0, t)$$

is a “flat” output. Indeed, the equation in the Laplace variable  $s$  reads

$$s\hat{\theta}(x, s) = \hat{\theta}''(x, s) \quad \text{with} \quad \hat{\theta}'(0, s) = 0, \quad \hat{\theta}(1, s) = \hat{u}(s)$$

( $'$  stands for  $\partial_x$  and  $\hat{\cdot}$  for the Laplace transform), and the solution is clearly  $\hat{\theta}(x, s) = \cosh(x\sqrt{s})\hat{u}(s)/\cosh(\sqrt{s})$ . As  $\hat{\theta}(0, s) = \hat{u}(s)/\cosh(\sqrt{s})$ , this implies

$$\hat{u}(s) = \cosh(\sqrt{s}) \hat{y}(s) \quad \text{and} \quad \hat{\theta}(x, s) = \cosh(x\sqrt{s}) \hat{y}(s).$$

Since  $\cosh \sqrt{s} = \sum_{i=0}^{+\infty} s^i/(2i)!$ , we eventually get

$$\theta(x, t) = \sum_{i=1}^{+\infty} x^{2i} \frac{y^{(i)}(t)}{(2i)!} \tag{40}$$

$$u(t) = \sum_{i=1}^{+\infty} \frac{y^{(i)}(t)}{(2i)!}. \tag{41}$$

In other words, whenever  $t \mapsto y(t)$  is an arbitrary function (i.e., a trajectory of the trivial system  $y = v$ ),  $t \mapsto (\theta(x, t), u(t))$  defined by (40)-(41) is a (formal) trajectory of (37)–(39), and vice versa. This is exactly the idea underlying the definition of flatness. Notice these calculations have been known for a long time, see [109, pp. 588 and 594].

To make the statement precise, we now turn to convergence issues. On the one hand,  $t \mapsto y(t)$  must be a smooth function such that

$$\exists K, M > 0, \quad \forall i \geq 0, \forall t \in [t_0, t_1], \quad |y^{(i)}(t)| \leq M(Ki)^{2i}$$

to ensure the convergence of the series (40)-(41).

On the other hand  $t \mapsto y(t)$  cannot in general be analytic. Indeed, if the system is to be steered from an initial temperature profile  $\theta(x, t_0) = \alpha_0(x)$  at time  $t_0$  to a final profile  $\theta(x, t_1) = \alpha_1(x)$  at time  $t_1$ , equation (37) implies

$$\forall t \in [0, 1], \forall i \geq 0, \quad y^{(i)}(t) = \partial_t^i \theta(0, t) = \partial_x^{2i} \theta(0, t),$$

and in particular

$$\forall i \geq 0, \quad y^{(i)}(t_0) = \partial_x^{2i} \alpha_0(0) \quad \text{and} \quad y^{(i)}(t_1) = \partial_x^{2i} \alpha_1(1).$$

If for instance  $\alpha_0(x) = c$  for all  $x \in [0, 1]$  (i.e., uniform temperature profile), then  $y(t_0) = c$  and  $y^{(i)}(t_0) = 0$  for all  $i \geq 1$ , which implies  $y(t) = c$  for all  $t$  when the function is analytic. It is thus impossible to reach any final profile but  $\alpha_1(x) = c$  for all  $x \in [0, 1]$ .

Smooth functions  $t \in [t_0, t_1] \mapsto y(t)$  that satisfy

$$\exists K, M > 0, \quad \forall i \geq 0, \quad |y^{(i)}(t)| \leq M(Ki)^{\sigma i}$$

are known as Gevrey-Roumieu functions of order  $\sigma$  [91] (they are also closely related to class  $S$  functions [32]). The Taylor expansion of such functions is convergent for  $\sigma \leq 1$  and divergent for  $\sigma > 1$  (the larger  $\sigma$  is, the “more divergent” the Taylor expansion is). Analytic functions are thus Gevrey-Roumieu of order  $\leq 1$ .



In other words we need a Gevrey-Roumieu function on  $[t_0, t_1]$  of order  $> 1$  but  $\leq 2$ , with initial and final Taylor expansions imposed by the initial and final temperature profiles. With such a function, we can then compute open-loop control steering the system from one profile to the other by the formula (40).

For instance, we steered the system from uniform temperature 0 at  $t = 0$  to uniform temperature 1 at  $t = 1$  by using the function

$$\mathbb{R} \ni t \mapsto y(t) := \begin{cases} 0 & \text{if } t < 0 \\ 1 & \text{if } t > 1 \\ \frac{\int_0^t \exp(-1/(\tau(1-\tau))^\gamma) d\tau}{\int_0^1 \exp(-1/(\tau(1-\tau))^\gamma) d\tau} & \text{if } t \in [0, 1], \end{cases}$$

with  $\gamma = 1$  (this function is Gevrey-Roumieu functions of order  $1+1/\gamma$ ). The evolution of the temperature profile  $\theta(x, t)$  is displayed on figure 16 (the Matlab simulation is available upon request at [rouchon@cas.ensmp.fr](mailto:rouchon@cas.ensmp.fr)).

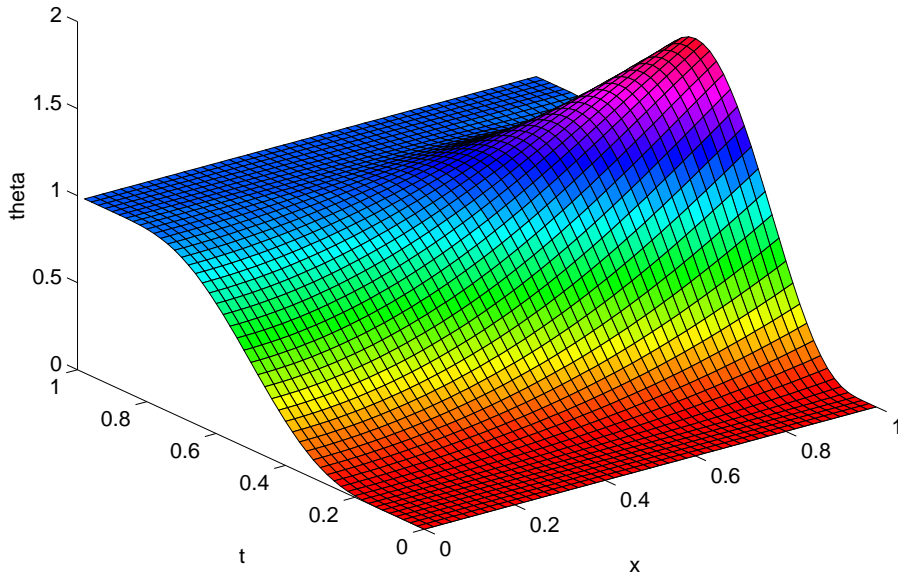

Figure 16: evolution of the temperature profile for  $t \in [0, 1]$ .

Similar but more involved calculations with convergent series corresponding to Mikusiński operators are used in [28, 29] to control a chemical reactor and a flexible rod modeled by an Euler-Bernoulli equation. For nonlinear systems, convergence issues are more involved and are currently under investigation. Yet, it is possible to work—at least formally—along the same line.

**Example 18 (Flexion beam system).** Consider with [43] the mixed system

$$\begin{aligned} \rho \partial_t^2 u(x, t) &= \rho \omega^2(t) u(x, t) - EI \partial_x^4 u(x, t), \quad x \in [0, 1] \\ \dot{\omega}(t) &= \frac{\Gamma_3(t) - 2\omega(t) \langle u, \partial_t u \rangle(t)}{I_d + \langle u, u \rangle(t)} \end{aligned}$$

with boundary conditions

$$u(0, t) = \partial_x u(0, t) = 0, \quad \partial_x^2 u(1, t) = \Gamma_1(t), \quad \partial_x^3 u(1, t) = \Gamma_2(t),$$

where  $\rho, EI, I_d$  are constant parameters,  $u(x, t)$  is the deformation of the beam,  $\omega(t)$  is the angular velocity of the body and  $\langle f, g \rangle(t) := \int_0^1 \rho f(x, t) g(x, t) dx$ . The three control inputs are  $\Gamma_1(t), \Gamma_2(t), \Gamma_3(t)$ .

We claim that

$$y(t) := (\partial_x^2 u(0, t), \partial_x^3 u(0, t), \omega(t))$$

is a “flat” output. Indeed,  $\omega(t), \Gamma_1(t), \Gamma_2(t)$  and  $\Gamma_3(t)$  can clearly be expressed in terms of  $y(t)$  and  $u(x, t)$ , which transforms the system into the equivalent Cauchy-Kovalevskaya form

$$EI \partial_x^4 u(x, t) = \rho y_3^2(t) u(x, t) - \rho \partial_t^2 u(x, t) \quad \text{and} \quad \begin{cases} u(0, t) = 0 \\ \partial_x u(0, t) = 0 \\ \partial_x^2 u(0, t) = y_1(t) \\ \partial_x^3 u(0, t) = y_2(t). \end{cases}$$

Set then formally  $u(x, t) = \sum_{i=0}^{+\infty} a_i(t) \frac{x^i}{i!}$ , plug this series into the above system and identify term by term. This yields

$$a_0 = 0, \quad a_1 = 0, \quad a_2 = y_1, \quad a_3 = y_2,$$

and the iterative relation  $\forall i \geq 0, EI a_{i+4} = \rho y_3^2 a_i - \rho \ddot{a}_i$ . Hence for all  $i \geq 1$ ,

$$\begin{aligned} a_{4i} &= 0 & a_{4i+2} &= \frac{\rho}{EI} (y_3^2 a_{4i-2} - \ddot{a}_{4i-2}) \\ a_{4i+1} &= 0 & a_{4i+3} &= \frac{\rho}{EI} (y_3^2 a_{4i-1} - \ddot{a}_{4i-1}). \end{aligned}$$

There is thus a 1–1 correspondence between (formal) solutions of the system and arbitrary mappings  $t \mapsto y(t)$ : the system is formally flat.

For recent results on nonlinear flexion systems see [101].

## 9 A catalog of infinite dimensional “flat systems”

### 9.1 Chemical réactor with a recycle loop

This example is borrowed to [100] where a catalogue of flat chemical systems is available. Take the exothermic chemical reactor studied in [3] (one reaction  $A \rightarrow B$  involving two species,  $A$  and  $B$ ) and add, as shown on figure 17, a recycle loop and a delay  $\tau_Q$  in the cooling system. Under classical assumption the mass and energy balances read

$$\begin{cases} \dot{x}(t) = D(x_F - x(t)) + D_R(x(t - \tau_R) - x(t)) - r(x(t), T(t)) \\ \dot{T}(t) = D(T_F - T(t)) + D_R(T(t - \tau_R) - T(t)) + \alpha r(x(t), T(t)) + Q(t - \tau_Q). \end{cases} \quad (42)$$

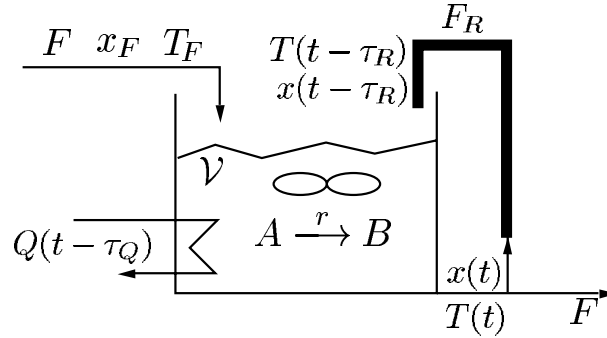

Figure 17: A chemical reactor with a recycle loop.

The concentration of  $A$  is denoted by  $x$  and the temperature by  $T$ . The control  $Q$  is proportional to the cooling duty. The constant parameters are:  $\alpha$  (reaction enthalpy);  $D$  (dilution rate);  $x_F$  and  $T_F$  (feed composition and temperature).

The recycle dynamics is described here by a delay  $\tau_R$  (plug flow without reaction nor diffusion). Denote by  $\mathcal{V}_R$  the volume of the recycle loop and  $F_R$  the recycle volumetric flow. Then  $\tau_R = \mathcal{V}_R/F_R$ . We will show that  $y = x(t)$  is the flat-output.

Assume that  $x(t) = y(t)$  is given. The mass balance (the first equation in (42)) defines implicitly the temperature  $T$  as a function of  $y(t)$ ,  $\dot{y}(t)$  and  $y(t - \tau_R)$ :

$$T(t) = \Theta(y(t), \dot{y}(t), y(t - \tau_R)).$$

The energy balance reads

$$Q(t - \tau_Q) = \dot{T}(t) - D(T_F - T(t)) - D_R(T(t - \tau_R) - T(t)) - \alpha r(y(t), T(t));$$

thus

$$Q(t) = \dot{T}(t + \tau_Q) - D(T_F - T(t + \tau_Q)) - D_R(T(t - \tau_R + \tau_Q) - T(t + \tau_Q)) - \alpha r(y(t + \tau_Q), T(t + \tau_Q)).$$

This means that  $Q(t)$  depends on  $y(t + \tau_Q)$ ,  $\dot{y}(t + \tau_Q)$ ,  $\ddot{y}(t + \tau_Q)$ ,  $y(t - \tau_R + \tau_Q)$ ,  $y(t - 2\tau_R + \tau_Q)$  et  $\dot{y}(t - \tau_R + \tau_Q)$ . Formally we have

$$Q(t) = \Lambda[y(t + \tau_Q), \dot{y}(t + \tau_Q), \ddot{y}(t + \tau_Q), y(t - \tau_R + \tau_Q), y(t - 2\tau_R + \tau_Q), \dot{y}(t - \tau_R + \tau_Q)].$$

The value of  $Q(t)$  for  $t \in [0, t_*]$  depends on  $y(t)$  for  $t \in [-2\tau_R + \tau_Q, t_* + \tau_Q]$ . To find a control steering the system from one steady state to another one, take  $t \mapsto y(t)$  constant outside of  $[0, t_*]$ . Then the transition starts at  $t = -\tau_Q$  for  $Q$ , at  $t = 0$  for  $T$  and  $x$ . The new steady-state is reached at  $t = t_*$  for  $x$ , at  $t = t_* + \tau_R$  for  $T$  and  $t = t_* + 2\tau_R - \tau_Q$  for  $Q$ .

## 9.2 The nonholonomic snake

When the number of trailers is large, it is natural, as displayed on figure 18, to introduce the continuous approximation of the “non-holonomic snake”. The trailers are

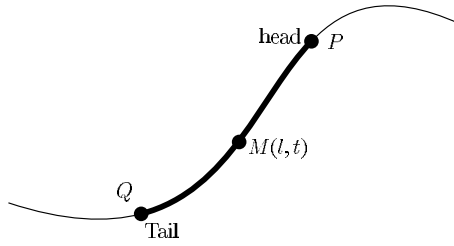

Figure 18: the non-holonomic snake, a car with an infinite number of small trailers.

now indexed by a continuous variable  $l \in [0, L]$  and their positions are given by a map  $[0, L] \ni l \mapsto M(l, t) \in \mathbb{R}^2$  satisfying the following partial differential equations:

$$\left\| \frac{\partial M}{\partial l} \right\| = 1, \quad \frac{\partial M}{\partial l} \wedge \frac{\partial M}{\partial t} = 0.$$

The first equation says that  $l \mapsto M(l, t)$  is an arc length parameterization. The second one is just the rolling without slipping conditions : velocity of trailer  $l$  is parallel to the direction of the plan of its wheels, i.e., the tangent to the curve  $l \mapsto M(l, t)$ . It is then obvious that the general solution of this system is

$$M(l, t) = P(s(t) - l), \quad l \in [0, L]$$

where  $P$  is the snake head and  $s \mapsto P(s)$  an arc length parameterization of the curve followed by  $P$ . Similarly,

$$M(l, t) = Q(s(t) + l), \quad l \in [0, L]$$

where  $Q$  is the snake tail. It corresponds to the flat output of the finite dimensional approximation, the  $n$ -trailers system of figure 9, with  $n$  large and  $d_i = L/n$ . Derivatives up to order  $n$  are in the infinite case replaced by advances in the arc length scale. This results from the formal relation

$$Q(s + l) = \sum_{i \geq 0} Q^{(i)}(s) l^i / i!$$

and the series truncation up to the first  $n$  terms. Nevertheless,  $M(l, t) = Q(s(t) + l)$  is much more simple to use in practice. When  $n$  is large, the series admit convergence troubles for  $s \mapsto Q(s)$  smooth but not analytic.

When the number of trailers is large and the curvature radius  $1/\kappa$  of  $s \mapsto Q(s)$  is much larger than the length of each small trailer, such infinite dimensional approximation is valid. It reduces the dynamics to trivial delays. It is noteworthy that, in this case, an infinite dimensional description yields to a much better reduced model than a finite dimensional description that gives complex nonlinear control models and algorithms <sup>1</sup>.

---

<sup>1</sup>The finite dimensional system does not require to be flat (trailer  $i$  can be hitched to trailer  $i - 1$  not directly at the center of its wheel axle, but more realistically at a positive distance of this point [60]).

### 9.3 Nonlinear heavy chain systems

The nonlinear conservative model of an homogenous heavy chain with an end mass is the following.

$$\left\{ \begin{array}{l} \rho \frac{\partial^2 M}{\partial t^2} = \frac{\partial}{\partial s} \left( T \frac{\partial M}{\partial s} \right) + \rho \vec{g} \\ \left\| \frac{\partial M}{\partial s} \right\| = 1 \\ M(L, t) = u(t) \\ T(0, t) \frac{\partial M}{\partial s}(0, t) = m \frac{\partial^2 M}{\partial t^2}(0, t) - m \vec{g}. \end{array} \right. \quad (43)$$

where  $[0, L] \ni s \mapsto M(s, t) \in \mathbb{R}^3$  is an arc length parameterization of the chain and  $T(s, t) > 0$  is the tension. The control  $u$  is the position of the suspension point. If we use

$$N(s, t) = \int_0^s M(\sigma, t) \, d\sigma$$

instead of  $M(s, t)$  (Bäcklund transformation) we have

$$\begin{aligned} \rho \frac{\partial^2 N}{\partial t^2} &= T(s, t) \frac{\partial^2 N}{\partial s^2}(s, t) - T(0, t) \frac{\partial^2 N}{\partial s^2}(0, t) + \rho s \vec{g} \\ \left\| \frac{\partial^2 N}{\partial s^2} \right\| &= 1 \\ \frac{\partial N}{\partial s}(L, t) &= u(t) \\ T(0, t) \frac{\partial^2 N}{\partial s^2}(0, t) &= m \frac{\partial^3 N}{\partial t^2 \partial s}(0, t) - m \vec{g} \\ N(0, t) &= 0. \end{aligned}$$

Assume that the load trajectory is given

$$t \mapsto y(t) = \frac{\partial N}{\partial s}(0, t).$$

Then (we take the positive branch)

$$T(s, t) = \left\| \rho \frac{\partial^2 N}{\partial t^2}(s, t) - (\rho s + m) \vec{g} + m \ddot{y}(t) \right\|$$

and we have the Cauchy-Kovalevsky problem

$$\begin{aligned} \frac{\partial^2 N}{\partial s^2}(s, t) &= \frac{1}{T(s, t)} \left( \rho \frac{\partial^2 N}{\partial t^2}(s, t) - (\rho s + m) \vec{g} + m \ddot{y}(t) \right) \\ N(0, t) &= 0 \\ \frac{\partial N}{\partial s}(0, t) &= y(t). \end{aligned}$$

Formally, its series solution expresses in terms of  $y$  and its derivatives of infinite order. This could be problematic since  $y$  must be analytic and the series converge for  $s \geq 0$  small enough.

We will see here below that the solution of the tangent linearization of this Cauchy-Kovalevsky system around the stable vertical steady-state can be expressed via advances and delays of  $y$ . Such a formulation avoids series with  $y$  derivatives of arbitrary orders. For the nonlinear system here above, we conjecture a solution involving non-linear delays and advances of  $y$ .

#### 9.4 Burger equation without diffusion [80]

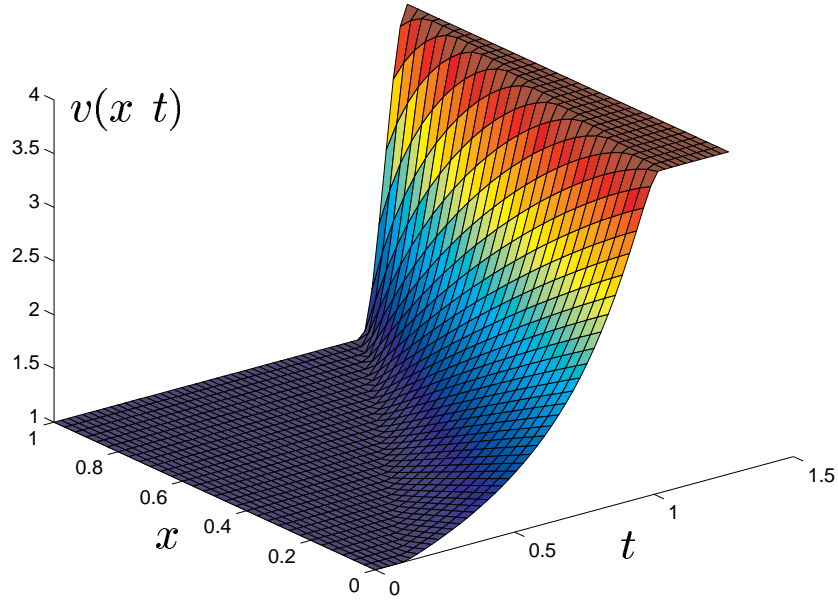

Figure 19: A velocity described by Burger equation; transition from low velocity  $v \equiv 1$  to a high velocity  $v \equiv 4$  without shock.

The Burger equation represent the velocity field in a one dimensional gas where particles have no interaction and have an inertial motion in a tube of length  $l$ :

$$\begin{aligned} \frac{\partial v}{\partial t} + v \frac{\partial v}{\partial x} &= 0 \quad x \in [0, l] \\ v(0, t) &= u(t) \end{aligned} \quad (44)$$

The field  $x \mapsto v(x, t)$  represents the velocity of the particles for  $x \in [0, l]$ . The control is the input velocity  $u(t) > 0$ .

The output velocity is  $y(t) = v(l, t)$ . Since the acceleration of each particle is zero, its velocity remains constant. Thus the particle coming out of the tube at time  $t$  has velocity equation to  $y(t)$ . At time  $t - l/y(t)$  this particle enters the tube in  $x = 0$  with velocity  $u(t - l/y(t))$ . Thus

$$y(t) = u(t - l/y(t)).$$

Similarly;

$$u(t) = y(t + 1/u(t)).$$

More generally :

$$y(t) = v(t - (1 - x)/y(t), x) \quad x \in [0, 1]$$

and

$$u(t) = v(t + x/u(t), x) \quad x \in [0, 1].$$

Formally, we have a one to one correspondence between  $t \mapsto v(\blacksquare, t)$ , solution of (44), and  $t \mapsto y(t)$ . This correspondence is effective as soon as  $y > 0$  is differentiable,  $t \mapsto t - (1 - x)/y(t)$  increasing for all  $x \in [0, l]$ , i.e., for all  $t$ ,  $\dot{y}(t) > -y^2(t)$ .

This condition corresponds to smooth solution and avoid shocks and discontinuous solution. It is then easy to find  $t \mapsto u(t)$  steering smoothly from a low velocity  $v(\blacksquare, 0) \equiv v_1 > 0$  to a high one  $v(\blacksquare, T) \equiv v_2 > v_1$  in a time  $T$ . Notice that the same computation remains valid for

$$\begin{aligned} v_t + \lambda(v)v_x &= 0 \quad x \in [0, l] \\ v(0, t) &= u(t). \end{aligned}$$

The relations between  $y(t) = v(l, t)$ ,  $u$  and  $v$  becomes (see, e.g., [13][page 41]):

$$y(t) = u[t - 1/\lambda(y(t))], \quad y(t) = v[t - (1 - x)/\lambda(y(t)), x].$$

## 9.5 Mixing processes

Example of figure 20 comes from [80], a system where delays depend on control. Using three tanks with base colors, the goal is to produce in the output tank a specified quantity and color.

Since the pipe volume are comparable to the output tank volume, delays appear. We assume plug flow in pipes  $\alpha$  and  $\beta$ . Knowing the output tank quantities,  $t \mapsto Y = (Y_1, Y_2, Y_3)$ , it is possible to derived explicitly the three control  $u = (u_1, u_2, u_3)$  and the color profile in pipes  $\alpha$  and  $\beta$  via  $Y$  and its time derivative  $\dot{Y}$ . Notations are as follows (see figure 20).

- a color (or composition) is a triplet  $(c_1, c_2, c_3)$  with  $\forall i = 1, 2, 3 \ 0 \leq c_i \leq 1$  and  $c_1 + c_2 + c_3 = 1$ .
- $b_i = (\delta_{ij})_{j=1,2,3}$  corresponds to base color in the input tank no  $i$ ,  $i = 1, 2, 3$ .
- $u = (u_1, u_2, u_3)^T$ : the output flow from the input tanks (the control).
- $\alpha = (\alpha_1, \alpha_2, 0)^T$  : color at mixing node  $\alpha$ .
- $\beta = (\beta_1, \beta_2, \beta_3)^T$ : color at mixing node  $\beta$ .
- $V$ : volume in the output tank.
- $X = (X_1, X_2, X_3)$ : color in the output tank.
- $Y = (Y_1, Y_2, Y_3)^T = (V.X_1, V.X_2, V.X_3)^T$  the three holdups in output tank.  $Y_1, Y_2, Y_3$  are increasing time functions.
- $V_\alpha$ : volume of pipe  $\alpha$ .
- $V_\beta$ : volume of pipe  $\beta$ .

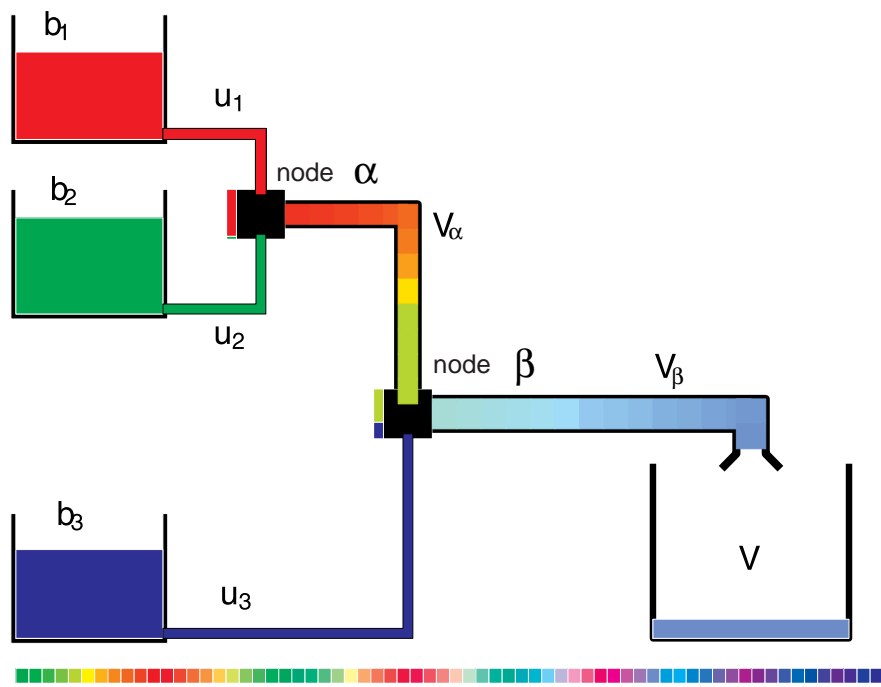

Figure 20: colors mixing; variable delays are due to non negligible pipe volumes  $V_\alpha$  and  $V_\beta$ .



Notice that

$$\alpha_1 + \alpha_2 = 1, \quad \beta_1 + \beta_2 + \beta_3 = 1, \quad X_1 + X_2 + X_3 = 1.$$

Balance equations provide  $u$ ,  $\alpha$  and  $\beta$  versus  $Y$ . Assume that  $t \mapsto \sigma(t) \mapsto Y(\sigma(t))$  is given:  $t \mapsto \sigma(t)$  is a smooth increasing time function and  $\sigma \mapsto Y_i(\sigma)$  is positive, smooth and strictly increasing,  $i = 1, 2, 3$ . Computations start from the output and finish at the input. The main steps are ( ' stands for  $d/d\sigma$ ):

1. solve (via , e.g., a Newton-like method) the scalar equation

$$\sum_{i=1}^3 Y_i(\sigma_\beta) = \sum_{i=1}^3 Y_i(\sigma(t)) + V_\beta$$

with  $\sigma_\beta$  as unknown.

2. solve, similarly

$$Y_1(\sigma_\alpha) + Y_2(\sigma_\alpha) = Y_1(\sigma_\beta) + Y_2(\sigma_\beta) + V_\alpha$$

with  $\sigma_\alpha$  as unknown.

3. set

$$\alpha_1(t) = \frac{Y_1'(\sigma_\alpha)}{Y_1'(\sigma_\alpha) + Y_2'(\sigma_\alpha)}, \quad \alpha_2(t) = 1 - \alpha_1(t).$$

and

$$\beta(t) = \left[ \frac{Y'}{V'} \right] (s_\beta)$$

with  $V = Y_1 + Y_2 + Y_3$ .

4. set

$$u_i(t) = \alpha_i(t) (Y_1'(\sigma_\beta) + Y_2'(\sigma_\beta)) V'(\sigma(t)) \dot{\sigma}(t) \quad i = 1, 2$$

and

$$u_3(t) = V'(\sigma(t)) \dot{\sigma}(t) - u_1(t) - u_2(t)$$

Assume now that we have to produce a series of batches of prescribed volumes and colors defined by  $Q^a = (Q_1^a, Q_2^a, Q_3^a)$ ,  $Q^b = (Q_1^b, Q_2^b, Q_3^b)$ ,  $Q^c, \dots$ . We cannot flush pipes  $\alpha$  and  $\beta$  between two batches. Define an increasing  $Y$ ,  $t \mapsto \sigma \mapsto Y_i$  as on figure 21. The clock law  $t \mapsto \sigma(t)$  admits horizontal tangent at  $t^a, t^b, t^c, \dots$  to ensure smooth transitions between batches.

## 9.6 Flexible beam (Euler-Bernoulli) [2, 28]

Symbolic computations “à la Heaviside” with  $s$  instead of  $\frac{\partial}{\partial t}$  are here important. We will not develop the formal aspect with Mikusiński operational calculus as in [28]. We just concentrate on the computations. We have the following 1D modelling:

$$\partial_{tt}X = -\partial_{xxxx}X$$

$$X(0, t) = 0, \quad \partial_x X(0, t) = \theta(t)$$

$$\ddot{\theta}(t) = u(t) + k\partial_{xx}X(0, t)$$

$$\partial_{xx}X(1, t) = -\lambda\partial_{tt}X(1, t)$$

$$\partial_{xxx}X(1, t) = \mu\partial_{tt}X(1, t)$$

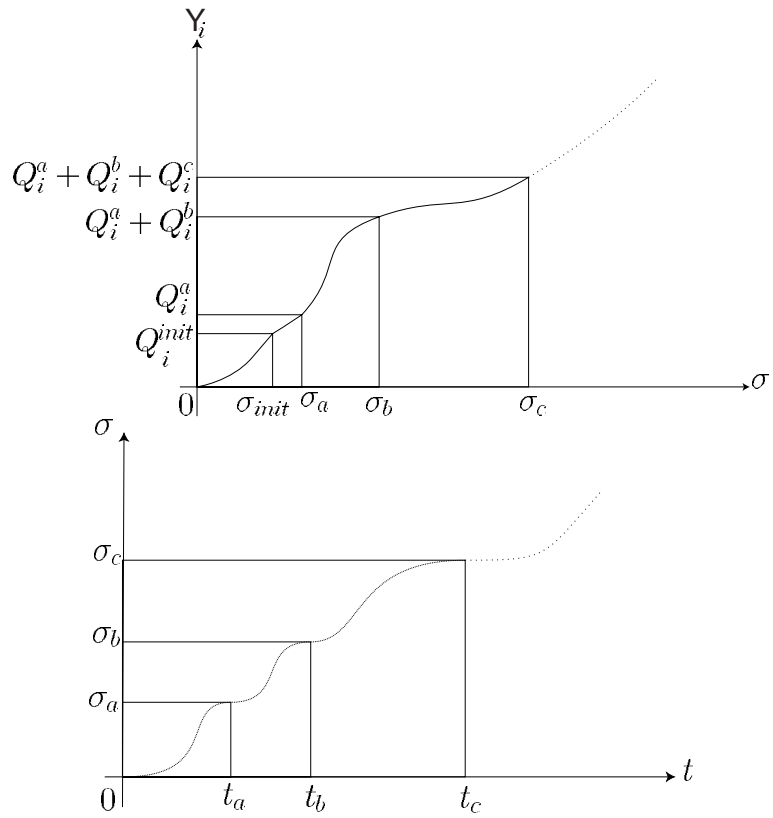

Figure 21: Batch scheduling via smooth flat output  $t \mapsto \sigma(t) \mapsto Y(\sigma(t))$ .

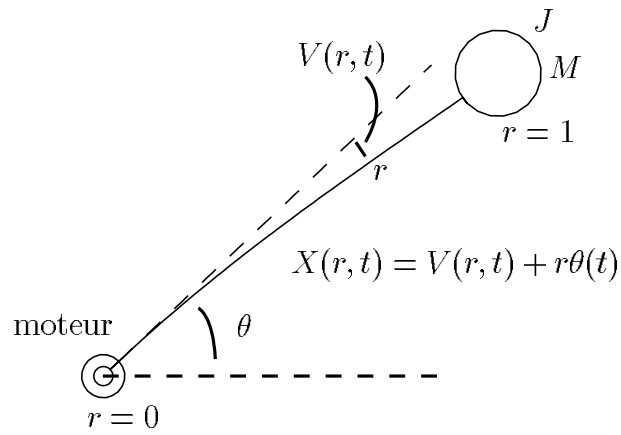

Figure 22: a flexible beam rotating around a control axle

where the control is the motor torque  $u$ ,  $X(r, t)$  is the deformation profile,  $k$ ,  $\lambda$  and  $\mu$  are physical parameters ( $t$  and  $r$  are in reduced scales).

We will show that the general solution expresses in term of an arbitrary  $C^\infty$  function  $y$  (Gevrey order  $\leq 2$  for convergence):

$$X(x, t) = \sum_{n \geq 0} \frac{(-1)^n y^{(2n)}(t)}{(4n)!} P_n(x) + \sum_{n \geq 0} \frac{(-1)^n y^{(2n+2)}(t)}{(4n+4)!} Q_n(x) \quad (45)$$

with  $\iota = \sqrt{-1}$ ,

$$P_n(x) = \frac{x^{4n+1}}{2(4n+1)} + \frac{(\Im - \Re)(1-x+\iota)^{4n+1}}{2(4n+1)} + \mu \Im(1-x+\iota)^{4n}$$

and

$$Q_n(x) = \frac{\lambda \mu}{2} (4n+4)(4n+3)(4n+2) ((\Im - \Re)(1-x+\iota)^{4n+1} - x^{4n+1}) - \lambda(4n+4)(4n+3)\Re(1-x+\iota)^{4n+2}$$

( $\Re$  and  $\Im$  stand for real part and imaginary part). Notice that  $\theta$  and  $u$  result from (45): it suffices to derive term by term.

We just show here how to get these formulas with  $\lambda = \mu = 0$  (no inertia at the free end  $r = 1$ ,  $M = J = 0$ ). The method remains unchanged in the general case. The question is: how to get

$$X(x, t) = \sum_{n \geq 0} \frac{y^{(2n)}(t)(-1)^n}{(4n)!} \pi_n(x) \quad (46)$$

with

$$\pi_n(x) = \frac{x^{4n+1}}{2(4n+1)} + \frac{(\Im - \Re)(1-x+\iota)^{4n+1}}{2(4n+1)}.$$

With the Laplace variable  $s$ , we have the ordinary differential system

$$X^{(4)} = -s^2 X$$

where

$$X(0) = 0, \quad X^{(2)}(1) = 0, \quad X^{(3)}(1) = 0.$$

Derivatives are with respect to the space variable  $r$  and  $s$  is here a parameter. The general solution depends on an arbitrary constant, i.e., an arbitrary function of  $s$ , since we have 3 boundary conditions. With the 4 elementary solutions of  $X^{(4)} = -s^2 X$

$$\begin{aligned} C_+(x) &= (\cosh((1-x)\sqrt{s}\xi) + \cosh((1-x)\sqrt{s}/\xi))/2 \\ C_-(x) &= (\cosh((1-x)\sqrt{s}\xi) - \cosh((1-x)\sqrt{s}/\xi))/(2\iota) \\ S_+(x) &= (\iota \sinh((1-x)\sqrt{s}\xi) + \sinh((1-x)\sqrt{s}/\xi))/(2\xi\sqrt{s}) \\ S_-(x) &= \xi(\iota \sinh((1-x)\sqrt{s}\xi) - \sinh((1-x)\sqrt{s}/\xi))/(2\sqrt{s}) \end{aligned}$$

where  $\xi = \exp(\iota\pi/4)$ ,  $X$  reads

$$X(x) = aC_+(x) + bC_-(x) + cS_+(x) + dS_-(x).$$

The 3 boundary conditions provide 3 equations relating the constant  $a$ ,  $b$ ,  $c$  and  $d$  :

$$\begin{aligned} aC_+(0) + bC_-(0) + cS_+(0) + dS_-(0) &= 0 \\ sb &= 0 \\ sc &= 0. \end{aligned}$$

Thus  $b = c = 0$  and we have just one relation between  $a$  and  $d$

$$aC_+(0) + dS_-(0) = 0.$$

Since

$$C_+(0) = \Re(\cosh(\xi\sqrt{s})), \quad S_-(0) = \Im(\xi \sinh(\xi\sqrt{s}/\sqrt{s}))$$

are entire functions of  $s$  very similar to  $\cosh(\sqrt{s})$  and  $\sinh \sqrt{s}/\sqrt{s}$  appearing for the heat equation (37), we can associate to them two operators, algebraically independent and commuting,

$$\delta_+ = C_+(0), \quad \delta_- = S_-(0).$$

They are in fact ultra-distributions belonging to the dual of Gevrey function of order less than  $\leq 2$  and with a punctual support [32]. We have thus a module generated by two elements  $(a, d)$  satisfying  $\delta_+a + \delta_-d = 0$ . This is a  $\mathbb{R}[\delta_+, \delta_-]$ -module. This module is not free but  $\delta_+$ -free [66]:

$$a = \delta_-y, \quad d = -\delta_+y$$

with  $y = -\delta_+^{-1}d$ .

The basis  $y$  plays the role of flat output since

$$X(x) = (S_-(0)C_+(x) - S_-(x)C_+(0))y.$$

Simple but tedious computations using hyperbolic trigonometry formulas yield then to

$$X(x) = -\frac{1}{2}[S_-(x) + \Im(S_-(1-x+i))]y.$$

The series of the entire function  $S_-$  provides (46). We conjecture that the quantity  $y$  admits a physical sense as an explicit expression with integrals of  $X$  over  $r \in [0, 1]$  (center of flexion).

## 9.7 Horizontal translation of the circular tank: the tumbler [83]

Take the 2D wave equation corresponding, in the linear approximation, to the surface wave generated by the horizontal motions of a cylindrical tank containing a fluid (linearized Saint-Venant equations (shallow water approximation)):

$$\begin{cases} \frac{\partial^2 \xi}{\partial t^2} = g\bar{h} \Delta \xi & \text{on } \Omega \\ g\nabla \xi \cdot n = -\ddot{D} \cdot n & \text{on } \partial\Omega \end{cases} \quad (47)$$

where  $\Omega$  is the interior of a circle of radius  $R$  and of center  $D(t) \in \mathbb{R}^2$ , the control ( $n$  is the normal to the boundary  $\partial\Omega$ ),  $\bar{h} + \xi$  is the height of liquid,  $g$  is the gravity. A family of solutions of (47) is given by the following formulas ( $(r, \theta)$  are the polar coordinates)

$$\xi(r, \theta, t) = \frac{1}{\pi} \sqrt{\frac{\bar{h}}{g}} \left( \int_0^{2\pi} \cos \alpha \left[ \dot{a} \left( t - \frac{r \cos \alpha}{c} \right) \cos \theta + \dot{b} \left( t - \frac{r \cos \alpha}{c} \right) \sin \theta \right] d\alpha \right)$$

and  $((u, v)$  are the Cartesian coordinates of  $D$ )

$$u = \frac{1}{\pi} \int_0^{2\pi} a \left( t - \frac{R \cos \alpha}{c} \right) \cos^2 \alpha \, d\alpha, \quad v = \frac{1}{\pi} \int_0^{2\pi} b \left( t - \frac{R \cos \alpha}{c} \right) \cos^2 \alpha \, d\alpha$$

where  $t \mapsto (a(t), b(t)) \in \mathbb{R}^2$  is an arbitrary smooth function.

## 9.8 Tubular reactor (convection/diffusion)

We recalled here [29, 100]. The controls are the input flux at  $z = 0$  of mass and energy.

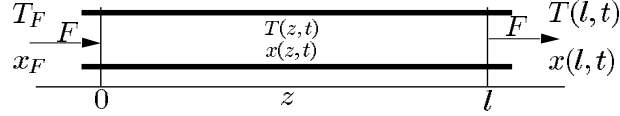

Figure 23: Adiabatic tubular reactor.

It is then possible to parameterize trajectories versus the outflow concentrations  $x(l, t)$  and temperature  $T(l, t)$ .

To simplify consider the tangent linearization around a steady-state. This gives the following convection-diffusion system:

$$\frac{\partial}{\partial t} \begin{bmatrix} x(z, t) \\ T(z, t) \end{bmatrix} = \Gamma \frac{\partial^2}{\partial z^2} \begin{bmatrix} x(z, t) \\ T(z, t) \end{bmatrix} - v \frac{\partial}{\partial z} \begin{bmatrix} x(z, t) \\ T(z, t) \end{bmatrix} + \begin{bmatrix} -r_x & -r_T \\ \alpha r_x & \alpha r_T \end{bmatrix} \begin{bmatrix} x(z, t) \\ T(z, t) \end{bmatrix}, \quad (48)$$

for  $z \in [0, l]$ , with boundary conditions

$$v \begin{bmatrix} x(0, t) \\ T(0, t) \end{bmatrix} - \Gamma \frac{\partial}{\partial z} \begin{bmatrix} x \\ T \end{bmatrix} \Big|_{0, t} = \begin{bmatrix} u_x(t) \\ u_T(t) \end{bmatrix}$$

$$\frac{\partial}{\partial z} \begin{bmatrix} x \\ T \end{bmatrix} \Big|_{l, t} = 0.$$

The controls are  $u_x$  and  $u_T$  at  $z = 0$ . The flow velocity  $v$  is uniform and constant. The diffusion matrix is  $\Gamma$ ;  $\alpha$  is related to enthalpy reactions. Partial derivatives of the kinetics  $r(x, T)$  are denoted by  $r_x$  and  $r_T$ . For simplicity, we assume here below that  $v$ ,  $\Gamma$ ,  $\alpha$ ,  $r_x$  and  $r_T$  are constants. But the computations remain valid but more involved when these quantities are analytic function of  $x$ .

Set  $y(t) \equiv [x(l, t), T(l, t)]'$  and take the series in  $(z - l)$  :

$$\begin{bmatrix} x \\ T \end{bmatrix} (z, t) = \sum_{i=0}^{\infty} \frac{(z-l)^i}{i!} a_i(t).$$

where  $a_i$  are vectors. We have

$$a_0(t) = y(t),$$

and

$$a_1(t) = 0.$$

The dynamics (48) implies the recurrence

$$a_{i+2} = \Gamma^{-1} \left[ \frac{da_i}{dt} + va_{i+1} + Ra_i \right], \quad i > 0, \quad (49)$$

with

$$R = \begin{bmatrix} r_x & r_T \\ -\alpha r_x & -\alpha r_T \end{bmatrix}.$$

Thus  $a_i$  is a function of  $y$  and its derivatives of order less than  $E(i/2)$ .

The control is then by setting  $z = 0$  in the series providing  $x$ ,  $T$ ,  $\frac{\partial x}{\partial z}$  and  $\frac{\partial T}{\partial z}$  :

$$\begin{bmatrix} x \\ T \end{bmatrix} (0, t) = \sum_{i=0}^{\infty} \frac{(-l)^i}{i!} a_i(t)$$

et

$$\frac{\partial}{\partial z} \begin{bmatrix} x \\ T \end{bmatrix} (0, t) = \sum_{i=0}^{\infty} \frac{(-l)^i}{i!} a_{i+1}(t).$$

thus

$$\begin{bmatrix} u_x(t) \\ u_T(t) \end{bmatrix} = \sum_{i=0}^{\infty} \frac{(-l)^i}{i!} (v a_i - \Gamma a_{i+1}). \quad (50)$$

The profiles  $x$  and  $T$  and the control  $u(t)$  depends on  $y$  and all its time derivatives. The convergence of the obtained series are still valid but less easy to prove than for the heat equation (see also [44, 52] for detailed convergence analysis of such series for linear and nonlinear cases).

## 9.9 The indian rope

Take the homogenous chain 15 and set  $g$  negative. This corresponds to an infinite series of inverted small pendulums. The dynamics reads

$$\frac{\partial^2 X}{\partial t^2} = -\frac{\partial}{\partial z} \left( g z \frac{\partial X}{\partial z} \right) \quad \text{pour } z \in [0, L], \quad X(L, t) = D(t) \quad (51)$$

with boundary control  $D(t)$ , the position of the trolley that is now under the chain. The flat output  $y = X(0, t)$  remains unchanged, and (35) becomes with a complex time:

$$X(z, t) = \frac{1}{2\pi} \int_0^\pi \left( y(t + 2\iota\sqrt{z/g} \sin \xi) + y(t - 2\iota\sqrt{z/g} \sin \xi) \right) d\xi$$

where  $\iota = \sqrt{-1}$ .

This relationship just means that, for any holomorphic function  $\mathbb{C} \ni \zeta \mapsto y(\zeta)$  whose restriction to the real axis is real, the quantity  $X(z, t)$  computed via the above integral is real and automatically satisfies

$$\frac{\partial^2 X}{\partial t^2} = -\frac{\partial}{\partial z} \left( g z \frac{\partial X}{\partial z} \right).$$

We are in face of a correspondence between system trajectories and the set of holomorphic functions  $] -\infty, +\infty[ \times [-2\sqrt{L/g}, 2\sqrt{L/g}] \ni \zeta \mapsto y(\zeta)$  that are real on the real axis. With  $y$  defined by ( $\sigma > 0$  is given)

$$y(\mu + \iota\nu) = \int_{-\infty}^{+\infty} \exp(-(\mu - \tau + \iota\nu)^2 / \sigma^2) f(\tau) d\tau$$

where  $\mathbb{R} \ni \tau \mapsto f(\tau) \in \mathbb{R}$  is measurable and bounded, we generate a large set of smooth trajectories. This can be used to solve approximatively some motion planning problems for such elliptic systems (ill-posed in the sense of Hadamard).

## 9.10 Drilling system

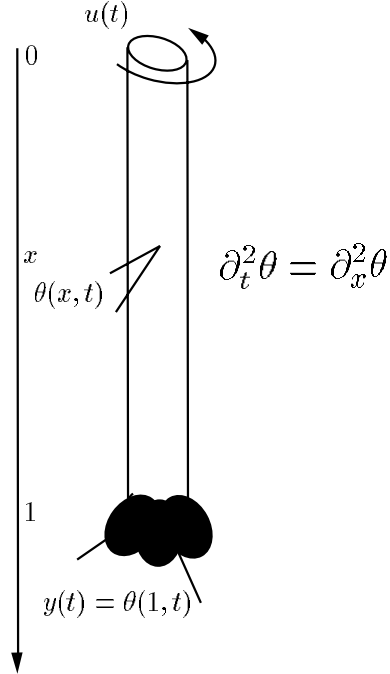

Figure 24: torsion dynamics of a drilling system.

The torsion dynamics of a drilling beam can be represented by a wave equations with non linear boundary conditions (normalized equations):

$$\begin{aligned} \partial_t^2 \theta &= \partial_x^2 \theta, & x \in [0, 1] \\ \partial_x \theta(0, t) &= -u(t) \\ \partial_x \theta(1, t) &= -F(\partial_t \theta(1, t)) - \partial_t^2 \theta(1, t) \end{aligned} \quad (52)$$

where  $[0, 1] \ni x \mapsto \theta(x, t)$  is the torsion profile à time  $t$ ,  $u$  is the control, the torque applied at the top of the beam. The behavior of the machinery cutting the rock is represented here by the non-linear function  $F$ .

More complex law can be used, the system remaining flat as soon as the dependence involve only  $y = \theta(1, t)$  the bottom position, the flat output of the system. Simple computations with d'Alembert formulae show that

$$2\theta(x, t) = y(t+1-x) + y(t-(1-x)) + \dot{y}(t+1-x) - \dot{y}(t-(1-x)) + \int_{t-(1-x)}^{t+(1-x)} F(\dot{y}(\tau)) d\tau.$$

## 9.11 Water tank

This example is borrowed to [16, 83]. The following problem is derived from an industrial process control problem where tanks filled with liquid are to be moved to

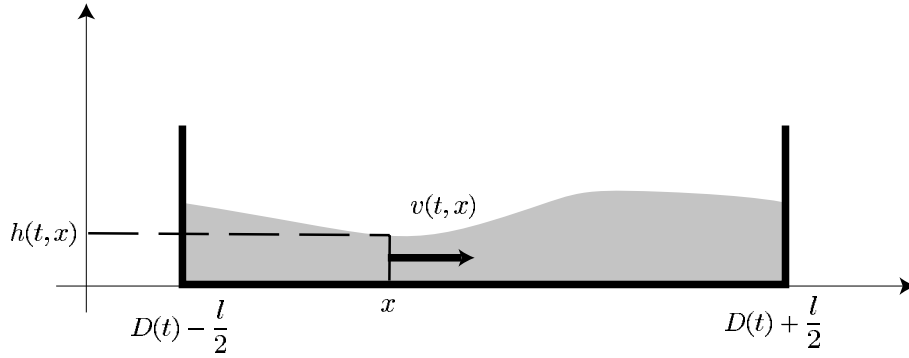

Figure 25: moving tank containing a perfect fluid.

different workbenches as fast as possible. To move such a tank horizontally, one has to take the motion of the liquid into account in order to prevent any overflowing. We assume that the motion of the fluid is described by the tangent linearization around the steady-state depth  $\bar{h}$  of Saint-Venant's equations [42]

$$\begin{cases} \frac{\partial^2 H}{\partial t^2} = \bar{h}g \frac{\partial^2 H}{\partial x^2} \\ \frac{\partial H}{\partial x}(a, t) = \frac{\partial H}{\partial x}(-a, t) = -\frac{u}{g} \\ \ddot{D} = u \end{cases}$$

with  $(H, \frac{\partial H}{\partial t}, D, \dot{D})$  as state and  $u$  as control. The liquid depth  $h = \bar{h} + H$  and the tank position is  $D$ . It is proved in [83] that the general solution passing through a steady state is given by

$$\begin{cases} H(x, t) = \frac{c}{2g} \left( \dot{y}(t - \frac{x}{c}) - \dot{y}(t + \frac{x}{c}) \right) \\ D(t) = \frac{1}{2} \left( y(t + \frac{l}{c}) + y(t - \frac{l}{c}) \right) \\ u(t) = \frac{1}{2} \left( \ddot{y}(t + \frac{l}{c}) + \ddot{y}(t - \frac{l}{c}) \right) \end{cases} \quad (53)$$

where  $y$  is an arbitrary time function. Moreover

$$y(t) = D(t) + \frac{1}{2\bar{h}} \left( \int_0^l H(x, t) dx - \int_{-l}^0 H(x, t) dx \right).$$

## 9.12 The electric line

We are interested in the propagation of an electric signal through an electric line of length  $\ell$ . Per unit of length, the resistance is  $R$ , the inductance is  $L$ , the capacity is



$C$  and the perditance is  $G$ . Kirschhoff's laws read (see for instance [94]):

$$\begin{aligned} L \frac{\partial i}{\partial t} &= -Ri - \frac{\partial v}{\partial x} \\ C \frac{\partial v}{\partial t} &= -\frac{\partial i}{\partial x} - Gv. \end{aligned}$$

where  $0 \leq x \leq \ell$ ,  $t \geq 0$ . Eliminating the current, we get the *telegraph equation*

$$\frac{\partial^2 v(x, t)}{\partial x^2} = (R + L \frac{\partial}{\partial t})(G + C \frac{\partial}{\partial t})v(x, t). \quad (54)$$

The boundary conditions are

$$\begin{aligned} v(0, t) &= u(t) \\ v(\ell, t) &= Zi(\ell, t). \end{aligned}$$

The input and the output of the system are respectively  $u(t) = v(0, t)$  and  $y(t) = v(\ell, t)$ . Let us prove that  $y$  is the flat output.

We turn (54) into the following ODE thanks to operational calculus

$$\hat{v}''(x, s) = \varpi(s)\hat{v}(x, s), \quad (55)$$

where  $\varpi(s) = (R + Ls)(G + Cs)$  and  $s$  stands for the time derivative. The boundary conditions now read

$$\hat{v}(0, s) = \hat{u}(s), \quad (R + Ls)\hat{v}(\ell, s) = Z\hat{v}'(\ell, s). \quad (56)$$

$\hat{u}$  et  $\hat{v}$  are the operational images of  $u$  and  $v$ . Clearly the general solution of (55) is

$$\hat{v}(x, s) = A(s)\text{ch}((\ell - x)\sqrt{\varpi(s)}) + B(s)\text{sh}((\ell - x)\sqrt{\varpi(s)}),$$

where  $A(s)$  and  $B(s)$  are independent of  $x$  and are determined by the boundary conditions (56). Now, instead of writing the relation between  $\hat{v}$  and  $\hat{u}$ , we write the relation between  $\hat{v}$  and  $\hat{y}(s) = \hat{v}(\ell, s)$ :

$$\begin{aligned} \hat{v}(x, s) &= \left( \text{ch}((\ell - x)\sqrt{\varpi(s)}) \right. \\ &\quad \left. + \frac{R + Ls}{Z} \frac{\text{sh}((\ell - x)\sqrt{\varpi(s)})}{\sqrt{\varpi(s)}} \right) \hat{y}(s). \end{aligned} \quad (57)$$

Notice the remarkable fact that the transfer function from  $\hat{y}$  to  $\hat{v}$  has only zeroes and no poles, i.e., is an analytic function (it is even an entire analytic function).

In particular, for  $x = 0$  (57) reads

$$\hat{u}(s) = \left( \text{ch}(\ell\sqrt{\varpi(s)}) + \frac{R + Ls}{Z} \frac{\text{sh}(\ell\sqrt{\varpi(s)})}{\sqrt{\varpi(s)}} \right) \hat{y}(s). \quad (58)$$

We now express formula (58) back into the time domain. For the sake of simplicity but without loss of generality, we assume  $G = 0$ . Let  $\lambda = \ell\sqrt{LC}$ ,  $\alpha = \frac{R}{2L}$ . Then

$\varpi(s) = RCs + LCs^2$  and (58) gives

$$\begin{aligned}
u(t) &= \frac{1}{2}e^{-\alpha\lambda}\left(1 - \frac{1}{Z}\sqrt{\frac{L}{C}}\right)y(t - \lambda) \\
&+ \frac{1}{2}e^{\alpha\lambda}\left(1 + \frac{1}{Z}\sqrt{\frac{L}{C}}\right)y(t + \lambda) \\
&+ \int_{-\lambda}^{+\lambda} \left(\frac{R}{4Z\sqrt{LC}}e^{-\alpha\tau}J_0(i\alpha\sqrt{\tau^2 - \lambda^2})\right. \\
&+ \left.\frac{e^{-\alpha\tau}i\alpha}{2\sqrt{\tau^2 - \lambda^2}}\right) \\
&\left(\lambda - \frac{1}{Z}\sqrt{\frac{L}{C}}\tau\right)J_1(i\alpha\sqrt{\tau^2 - \lambda^2})y(t - \tau)d\tau
\end{aligned} \tag{59}$$

where  $J_0$  et  $J_1$  are Bessel functions of the first kind.

Notice that the last formula is indeed the equation of a noncausal prefilter  $\mathcal{F}$  with compact support ( $u(t)$  is expressed in terms of the values of  $y$  over the finite interval  $[t - \lambda, t + \lambda]$ ). This can be used to compensate by a prefilter the distortion of an input signal along the electric line.

### 9.13 Isentropic gas dynamics in one dimension

Take a pipe described by  $x \in [0, L]$  and containing an isentropic ideal gas of constant specific heats, with positive velocity  $v(x, t)$  and sound-speed  $a(x, t)$  (see [112], chapter 6). Assume that the pressure at  $z = L$  is given, i.e. that  $a(L, t)$  is given and that the control is the input velocity  $u(t) = v(0, t)$ . The dynamics read ( $\gamma$  is a positive constant, equal to 5/3 or 7/5 for mono-atomic or bi-atomic gas):

$$\begin{aligned}
a_t + va_x + \frac{\gamma - 1}{2}av_x &= 0 \\
v_t + vv_x + \frac{2}{\gamma - 1}aa_x &= 0 \\
a(L, t) &= \bar{a}, \quad v(0, t) = u(t)
\end{aligned}$$

where  $a_t$  stands for  $\partial a / \partial t$ , ...

Consider the hodograph transformation exchanging the role of dependent variables  $(a, u)$  and independent variables  $(t, x)$ . Then  $t$  and  $x$  are functions of  $a$  and  $v$  with

$$x_v = \frac{-a_t}{v_t a_x - a_t v_x}, \quad t_v = \frac{a_x}{v_t a_x - a_t v_x}, \quad x_a = \frac{v_t}{v_t a_x - a_t v_x}, \quad t_a = \frac{-v_x}{v_t a_x - a_t v_x}.$$

This transformation is defined locally when  $v_t a_x - a_t v_x \neq 0$ .

Now  $t$  and  $x$  satisfy a linear partial system:

$$\begin{aligned}
x_v - vt_v + \frac{\gamma - 1}{2}at_a &= 0 \\
x_a - vt_a + \frac{2}{\gamma - 1}at_v &= 0.
\end{aligned}$$

Elimination of  $x$  yields

$$t_{bb} + \frac{2n}{b}t_b = t_{vv}$$

where  $b = 2a/(\gamma - 1)$ . When  $n$  is an integer its general solution is

$$t = \left( \frac{\partial^2}{\partial v^2} - \frac{\partial^2}{\partial b^2} \right)^{n-1} \left( \frac{F(v+b) + G(v-b)}{b} \right)$$

where  $F$  and  $G$  are arbitrary functions.

We continue the computations in the interesting case  $\gamma = 5/3$ , i.e.,  $n = 2$ . Then the general solution of linear partial differential system here above reads:

$$\begin{aligned} t &= \frac{F'(v+b) - G'(v-b)}{b^2} - 2 \frac{F(v+b) + G(v-b)}{b^3} \\ x &= \left( \frac{v}{b^2} - \frac{1}{3b} \right) F'(v+b) + \left( \frac{1}{3b^2} - \frac{2v}{b^3} \right) F(v+b) \\ &\quad - \left( \frac{1}{3b} + \frac{v}{b^2} \right) G'(v-b) - \left( \frac{1}{3b^2} + \frac{2v}{b^3} \right) G(v-b). \end{aligned}$$

The boundary constraint at  $x = L$ ,  $a = \bar{a}$  or  $b = \bar{b} = 2\bar{a}/\gamma$  becomes then a linear  $v$ -varying delay equation between  $F$  and  $G$ :

$$L = \left( \frac{v}{\bar{b}^2} - \frac{1}{3\bar{b}} \right) F'(v+\bar{b}) + \left( \frac{1}{3\bar{b}^2} - \frac{2v}{\bar{b}^3} \right) F(v+\bar{b}) - \left( \frac{1}{3\bar{b}} + \frac{v}{\bar{b}^2} \right) G'(v-\bar{b}) - \left( \frac{1}{3\bar{b}^2} + \frac{2v}{\bar{b}^3} \right) G(v-\bar{b}).$$

Its general solution expresses in terms of

$$Y(v) = \frac{v(F(v+\bar{b}) - G(v-\bar{b}))}{\bar{b}^2} - \frac{F(v+\bar{b}) + G(v-\bar{b})}{3\bar{b}},$$

its first derivative, its advance and delay. It suffices to solve the following linear system in  $H(v) = F(v+\bar{b}) - G(v-\bar{b})$  and  $I(v) = F(v+\bar{b}) + G(v-\bar{b})$

$$\begin{aligned} vH - \frac{\bar{b}}{3}I &= \bar{b}^2 Y(v) \\ \frac{\bar{b}}{3}H + vI &= \frac{\bar{b}^3}{2}(Y'(v) - L). \end{aligned}$$

This computation means that formally as for the mixing process (see subsection 9.5), the trajectories can be explicitly parameterized. This is achieved by enlarging the set of allowed manipulations (classical algebraic computations, time derivations, advances, delays) by using compositions and inversions of functions. Such approach could be of some use for the design of open-loop control steering from low-velocity to high-velocity, without shocks during the transient (as for the Burger equation of subsection 9.4).

Since for  $\gamma = 2$  we recover the Saint-Venant equations of shallow water dynamics, such hodograph transformations could be used to design open-loop trajectories avoiding flooding for irrigation canals [12].

## References

- [1] J. Alvarez, R. Suarez, and A. Sanchez. Nonlinear decoupling control of free-radical polymerization continuous stirred tank reactors. *Chem. Engng. Sci.*, 45:3341–3357, 1990.

- [2] Y. Aoustin, M. Fliess, H. Mounier, P. Rouchon, and J. Rudolph. Theory and practice in the motion planning and control of a flexible robot arm using mikusiński operators. In *Proc. of the Fifth IFAC Symposium on Robot Control*, pages 287–293, Nantes, France, 1997.
- [3] R. Aris and N.R. Amundson. An analysis of chemical reactor stability and control- i,ii,iii. *Chem. Engng. Sci.*, 7:121–155, 1958.
- [4] G. Bastin and Dochain. *On-Line Estimation and Adaptive Control of Bioreactors*. Elsevier Science Publishing Co, 1990.
- [5] R.L. Bryant, S.S. Chern, R.B. Gardner, H.L. Goldschmidt, and P.A. Griffiths. *Exterior Differential Systems*. Springer, 1991.
- [6] C.I. Byrnes and A. Isidori. On the attitude stabilization of rigid spacecraft. *Automatica*, 27:87–95, 1991.
- [7] G. Campion, B. d’Andrea Novel, and G. Bastin. Structural properties and classification of kinematic and dynamic models of wheeled mobile robots. *IEEE Trans. Robotics Automation*, 12(1):47–62, 1996.
- [8] E. Cartan. Sur l’équivalence absolue de certains systèmes d’équations différentielles et sur certaines familles de courbes. *Bull. Soc. Math. France*, 42:12–48, 1914. Also in *Œuvres Complètes*, part II, vol. 2, pp.1133–1168, CNRS, Paris, 1984.
- [9] E. Cartan. Sur l’intégration de certains systèmes indéterminés d’équations différentielles. *J. für reine und angew. Math.*, 145:86–91, 1915. Also in *Œuvres Complètes*, part II, vol. 2, pp.1164–1174, CNRS, Paris, 1984.
- [10] B. Charlet, J. Lévine, and R. Marino. On dynamic feedback linearization. *Systems Control Letters*, 13:143–151, 1989.
- [11] J. Chiasson. Dynamic feedback linearization of the induction motor. *IEEE Trans. Automat. Control*, 38:1588–1594, 1993.
- [12] J.M. Coron and G. Bastin B. D’Andréa-Novel. A lyapunov approach to control irrigation canals modeled by saint-venant equations. In *Proc. European Control Conference, Karlsruhe*, 1999.
- [13] R. Courant and D. Hilbert. *Methods of Mathematical Physics*, volume 2. Interscience, 1962.
- [14] E. Delaleau and J. Rudolph. Decoupling and linearization by quasi-static feedback of generalized states. In *Proc. of the 3rd European Control Conf.*, pages 1069–1074, Rome, 1995.
- [15] E. Delaleau and J. Rudolph. Control of flat systems by quasi-static feedback of generalized states. *Int. Journal of Control*, 71:745–765, 1998.
- [16] F. Dubois, N. Petit, and P. Rouchon. Motion planing and nonlinear simulations for a tank containing a fluid. In *European Control Conference, Karlsruhe*, 1999.
- [17] J. El Moubaraki, G. Bastin, and J. Lévine. Nonlinear control of biological processes with growth/production decoupling. *Mathematical Biosciences*, 116:21–44, 1993.
- [18] M. Fliess, J. levine, P. Martin, F. Ollivier, and P. Rouchon. Controlling nonlinear systems by flatness. In C.I. Byrnes, B.N. Datta, D.S. Gilliam, and C.F. Martin, editors, *Systems and control in the Twenty-First Century*, Progress in Systems and Control Theory. Birkhauser, 1997.

- [19] M. Fliess, J. Lévine, Ph. Martin, and P. Rouchon. Sur les systèmes non linéaires différentiellement plats. *C.R. Acad. Sci. Paris*, I-315:619–624, 1992.
- [20] M. Fliess, J. Lévine, Ph. Martin, and P. Rouchon. Linéarisation par bouclage dynamique et transformations de Lie-Bäcklund. *C.R. Acad. Sci. Paris*, I-317:981–986, 1993.
- [21] M. Fliess, J. Lévine, Ph. Martin, and P. Rouchon. Design of trajectory stabilizing feedback for driftless flat systems. In *Proc. of the 3rd European Control Conf.*, pages 1882–1887, Rome, 1995.
- [22] M. Fliess, J. Lévine, Ph. Martin, and P. Rouchon. Flatness and defect of nonlinear systems: introductory theory and examples. *Int. J. Control*, 61(6):1327–1361, 1995.
- [23] M. Fliess, J. Lévine, Ph. Martin, and P. Rouchon. Nonlinear control and difficulties, with an application to physics. *Contemporary Mathematics*, 219:81–92, 1998.
- [24] M. Fliess, J. Lévine, Ph. Martin, and P. Rouchon. A Lie-Bäcklund approach to equivalence and flatness of nonlinear systems. *IEEE AC*, 44:922–937, 1999.
- [25] M. Fliess and R. Marquez. Continuous time linear predictive control and flatness: a module theoretic setting with examples. *Int. Journal of Control*, 73:606–623, 2000.
- [26] M. Fliess, Ph. Martin, N. Petit, and P. Rouchon. Active signal restoration for the telegraph equation. In *CDC 99*, Phenix, december 1999.
- [27] M. Fliess, H. Mounier, P. Rouchon, and J. Rudolph. Controllability and motion planning for linear delay systems with an application to a flexible rod. In *Proc. of the 34th IEEE Conf. on Decision and Control*, pages 2046–2051, New Orleans, 1995.
- [28] M. Fliess, H. Mounier, P. Rouchon, and J. Rudolph. Systèmes linéaires sur les opérateurs de Mikusiński et commande d’une poutre flexible. In *ESAIM Proc. “Élasticité, viscolélasticité et contrôle optimal”, 8ème entretiens du centre Jacques Cartier, Lyon*, pages 157–168, 1996.
- [29] M. Fliess, H. Mounier, P. Rouchon, and J. Rudolph. A distributed parameter approach to the control of a tubular reactor: A multi- variable case. In *Control and Decision Conference, Tampa*, pages 439– 442, 1998.
- [30] M. Fliess, H. Mounier, P. Rouchon, and J. Rudolph. Tracking control of a vibrating string with an interior mass viewed as delay system. *ESAIM: COCV*([www.eamth.fr/cocv](http://www.eamth.fr/cocv)), 3:315–321, 1998.
- [31] M. Gromov. *Partial Differential Relations*. Springer-Verlag, 1986.
- [32] I.M. Guelfand and G.E. Chilov. *Les Distributions, tome 3*. Dunod, Paris, 1964.
- [33] J. Hauser, S. Sastry, and P. Kokotović. Nonlinear control via approximated input-output linearization: the ball and beam example. *IEEE Trans. Automat. Contr.*, 37:392–398, 1992.
- [34] J. Hauser, S. Sastry, and G. Meyer. Nonlinear control design for slightly nonminimum phase systems: Application to V/STOL aircraft. *Automatica*, 28(4):665–679, 1992.
- [35] D. Hilbert. Über den Begriff der Klasse von Differentialgleichungen. *Math. Ann.*, 73:95–108, 1912. also in *Gesammelte Abhandlungen*, vol. III, pp. 81–93, Chelsea, New York, 1965.

- [36] K.A. Hoo and J.C. Kantor. An exothermic continuous stirred tank reactor is feedback equivalent to a linear system. *Chem. Eng. Commun.*, 37:1–10, 1985.
- [37] L.R. Hunt, R. Su, and G. Meyer. Global transformations of nonlinear systems. *IEEE Trans. Automat. Control*, 28:24–31, 1983.
- [38] B. Jakubczyk and W. Respondek. On linearization of control systems. *Bull. Acad. Pol. Sci. Ser. Sci. Math.*, 28:517–522, 1980.
- [39] L. Karsenti and P. Rouchon. A tracking controller-observer scheme for DC-to-DC converters. In *ECC'97*, 1997.
- [40] C. Kravaris and C.B. Chung. Nonlinear state feedback synthesis by global input/output linearization. *AIChE J.*, 33:592–603, 1987.
- [41] M. Krstić, I. Kanellakopoulos, and P. Kokotović. *Nonlinear and Adaptive Control Design*. John Wiley & Sons, Inc., 1995.
- [42] L. Landau and E. Lifchitz. *Mécanique des fluides*. Mir Moscou, second edition, 1986.
- [43] H. Laoufy, C.Z. Xu, and G. Sallet. Boundary feedback stabilization of rotation body-beam system. *IEEE Autom. Control*, 41:1–5, 1996.
- [44] B. Laroche, Ph. Martin, and P. Rouchon. Motion planning for a class of partial differential equations with boundary control. In *IEEE-CDC, Tampa*, pages 3494–3497, 1998.
- [45] B. Laroche, Ph. Martin, and P. Rouchon. Motion planning for the heat equation. *Int. Journal of Robust and Nonlinear Control*, 10:629–643, 2000.
- [46] C. Lemon and J.E. Hause. Design and initial flight test of the Champagne Flyer. In *Proc. 33rd IEEE Conf. Decision and Control*, pages 3852–3853, Lake Buena Vista, 1994.
- [47] Y. Lenoir, Ph. Martin, and P. Rouchon.  $2k\pi$ , the juggling robot. In *Control and Decision Conference, Tampa*, pages 1995–2000, 1998.
- [48] W. Leonhard. *Control of Electrical Drives*. Elsevier, 1985.
- [49] J. Lévine. Are there new industrial perspectives in the control of mechanical systems? In P. Frank, editor, *In Issues in Control, ECC99*. Springer, 1999.
- [50] J. Lévine, J. Lottin, and J.-C. Ponsart. A nonlinear approach to the control of magnetic bearings. *IEEE Trans. Control Systems Technology*, 4:524–544, 1996.
- [51] J. Lévine, P. Rouchon, G. Yuan, C. Grebogi, B.R. Hunt, E. Kostelich, E. Ott, and J.A. Yorke. On the control of US Navy cranes. In *ECC97*, 1997.
- [52] A. F. Lynch and J. Rudolph. Flatness-based boundary control of a nonlinear parabolic equation modelling a tubular reactor. In *Nonlinear control in the year 2000 (Paris, 2000)*, A. Isidori, F. Lamnabhi-Lagarrique, and W. Respondek, Eds., pages 45–54. vol. 259, Lecture notes in control and information sciences, Springer, 2000.
- [53] Ph. Martin. *Contribution à l'étude des systèmes différentiellement plats*. PhD thesis, École des Mines de Paris, 1992.
- [54] Ph. Martin. A geometric sufficient conditions for flatness of systems with  $m$  inputs and  $m + 1$  states. In *Proc. of the 32nd IEEE Conf. on Decision and Control*, pages 3431–3436, San Antonio, 1993.

- [55] Ph. Martin. An intrinsic condition for regular decoupling. *Systems & Control Letters*, 20:383–391, 1993.
- [56] Ph. Martin. Endogenous feedbacks and equivalence. In *Systems and Networks: Mathematical Theory and Applications (MTNS'93)*, volume II, pages 343–346. Akademie Verlag, Berlin, 1994.
- [57] Ph. Martin, S. Devasia, and B. Paden. A different look at output tracking: control of a VTOL aircraft. *Automatica*, 32:101–108, 1995.
- [58] Ph. Martin, S. Devasia, and B. Paden. A different look at output feedback: control of a VTOL aircraft. *Automatica*, 32(1):101–108, 1996.
- [59] Ph. Martin, R. Murray, and P. Rouchon. Flat systems. In *Proc. of the 4th European Control Conf.*, pages 211–264, Brussels, 1997. Plenary lectures and Mini-courses.
- [60] Ph. Martin and P. Rouchon. Feedback linearization and driftless systems. *Math. Control Signal Syst.*, 7:235–254, 1994.
- [61] Ph. Martin and P. Rouchon. Any (controllable) driftless system with 3 inputs and 5 states is flat. *Systems Control Letters*, 25:167–173, 1995.
- [62] Ph. Martin and P. Rouchon. Any (controllable) driftless system with  $m$  inputs and  $m+2$  states is flat. In *Proc. of the 34th IEEE Conf. on Decision and Control*, pages 2886–2891, New Orleans, 1995.
- [63] Ph. Martin and P. Rouchon. Flatness and sampling control of induction motors. In *Proc. IFAC World Congress*, pages 389–394, San Francisco, 1996.
- [64] M. B. Milam and R. M. Murray. A testbed for nonlinear flight control techniques: The Caltech ducted fan. In *Proc. IEEE International Conference on Control and Applications*, 1999.
- [65] M. B. Milam, K. Mushambi, and R. M. Murray. A new computational approach to real-time trajectory generation for constrained mechanical systems. In *IEEE Conference on Decision and Control*, 2000.
- [66] H. Mounier. *Propriétés structurelles des systèmes linéaires à retards: aspects théoriques et pratiques*. PhD thesis, Université Paris Sud, Orsay, 1995.
- [67] H. Mounier and J. Rudolph. Flatness based control of nonlinear delay systems: A chemical reactor example. *Int. Journal of Control*, 71:871–890, 1998.
- [68] H. Mounier, J. Rudolph, M. Fliess, and P. Rouchon. Tracking control of a vibrating string with an interior mass viewed as delay system. *ESAIM: COCV* ([www.eamth.fr/cocv](http://www.eamth.fr/cocv)), 3:315–321, 1998.
- [69] H. Mounier, J. Rudolph, M. Petitot, and M. Fliess. A flexible rod as a linear delay system. In *Proc. of the 3rd European Control Conf.*, pages 3676–3681, Rome, 1995.
- [70] R. M. Murray. Trajectory generation for a towed cable flight control system. In *Proc. IFAC World Congress*, pages 395–400, San Francisco, 1996.
- [71] R. M. Murray, M. Rathinam, and W. Sluis. Differential flatness of mechanical control systems: A catalog of prototype systems. In *ASME International Mechanical Engineering Congress and Exposition*, 1995.
- [72] R.M. Murray. Nilpotent bases for a class on nonintegrable distributions with applications to trajectory generation for nonholonomic systems. *Math. Control Signal Syst.*, 7:58–75, 1994.

- [73] R.M. Murray and S.S. Sastry. Nonholonomic motion planning: Steering using sinusoids. *IEEE Trans. Automat. Control*, 38:700–716, 1993.
- [74] Iu I. Neimark and N.A. Fufaev. *Dynamics of Nonholonomic Systems*, volume 33 of *Translations of Mathematical Monographs*. American Mathematical Society, Providence, Rhode Island, 1972.
- [75] M. van Nieuwstadt and R. M. Murray. Approximate trajectory generation for differentially flat systems with zero dynamics. In *Proc. of the 34th IEEE Conf. on Decision and Control*, pages 4224–4230, New Orleans, 1995.
- [76] M. van Nieuwstadt and R.M. Murray. Real time trajectory generation for differentially flat systems. *Int. Journal of Robust and Nonlinear Control*, 8(11):995–1020, 1998.
- [77] H. Nijmeijer and A.J. van der Schaft. *Nonlinear Dynamical Control Systems*. Springer-Verlag, 1990.
- [78] P.J. Olver. *Applications of Lie groups to differential equations*, volume 107 of *Graduate Texts in Mathematics*. Springer-Verlag, 2nd edition, 1993.
- [79] N. Petit, Y. Creff, and P. Rouchon.  $\delta$ -freeness of a class of linear delayed systems. In *European Control Conference, Brussels*, 1997.
- [80] N. Petit, Y. Creff, and P. Rouchon. Motion planning for two classes of nonlinear systems with delays depending on the control. In *Control and Decision Conference, Tampa*, pages 1007–1011, 1998.
- [81] N Petit, Y. Creff, and P. Rouchon. Minimum time constrained control of acid strength on a sulfuric acid alkylation unit. *Chemical Engineering Science*, 56(8), 2001.
- [82] N. Petit, M. B. Milam, and R. M. Murray. Inversion based constrained trajectory optimization. In *NOLCOS, 5th IFAC symposium on nonlinear control systems*, 2001.
- [83] N. Petit and P. Rouchon. Dynamics and solutions to some control problems for water-tank systems. *IEEE AC*, 2001. accepted for publication.
- [84] N. Petit and P. Rouchon. Motion planning for heavy chain systems. *SIAM J. Control and Optim.*, 41(2):475–495, 2001.
- [85] J.B. Pomet. A differential geometric setting for dynamic equivalence and dynamic linearization. In *Workshop on Geometry in Nonlinear Control, Banach Center Publications, Warsaw*, 1993.
- [86] J.B. Pomet. On dynamic feedback linearization of four-dimensional affine control systems with two inputs. *ESAIM-COCV*, 1997. <http://www.emath.fr/Maths/Cocv/Articles/articleEng.html>.
- [87] J.B. Pomet, C. Moog, and E. Aranda. A non-exact Brunovsky form and dynamic feedback linearization. In *Proc. of the 31st IEEE Conf. on Decision and Control*, pages 2012–2017, 1992.
- [88] J.F. Pommaret. *Systems of Partial Differential Equations and Lie Pseudogroups*. Gordon & Breach, N.Y., 1978.
- [89] J.F. Pommaret. Dualité différentielle et applications. *C.R. Acad. Sci. Paris, Série I*, 320:1225–1230, 1995.
- [90] C. Raczy. *Commandes optimales en temps pour les systèmes différentiellement plats*. PhD thesis, Université des Sciences et Technologies de Lille, 1997.



- [91] J.P. Ramis. Dévissage Gevrey. *Astérisque*, 59-60:173–204, 1979.
- [92] M. Rathinam and R. Murray. Configuration flatness of Lagrangian systems underactuated by one control. *SIAM J. Control Optimization*, 36(1):164–179, 1998.
- [93] A. Reghai. Satellite à deux commandes. Technical report, Ecole Polytechnique, Palaiseau, France, 1995. Mémoire de fin d'études.
- [94] Y. Rocard. *Dynamique générale des vibrations*. Masson, Paris, 1971.
- [95] R. Rothfuß, J. Rudolph, and M. Zeitz. Flatness based control of a nonlinear chemical reactor model. *Automatica*, 32:1433–1439, 1996.
- [96] P. Rouchon. Necessary condition and genericity of dynamic feedback linearization. *J. Math. Systems Estim. Control*, 5(3):345–358, 1995.
- [97] P. Rouchon, M. Fliess, J. Lévine, and Ph. Martin. Flatness and motion planning: the car with n-trailers. In *Proc. ECC'93, Groningen*, pages 1518–1522, 1993.
- [98] P. Rouchon, M. Fliess, J. Lévine, and Ph. Martin. Flatness, motion planning and trailer systems. In *Proc. of the 32nd IEEE Conf. on Decision and Control*, pages 2700–2705, San Antonio, 1993.
- [99] P. Rouchon and J. Rudolph. *Invariant tracking and stabilization: problem formulation and examples*, pages 261–273. Lecture Notes in Control and Information Sciences 246. Springer, 1999.
- [100] P. Rouchon and J. Rudolph. *Commande de procédés chimiques: réacteurs et colonnes de distillation*, chapter Réacteurs chimiques différentiellement plats: planification et suivi de trajectoires, pages 163–200. Traité IC2. J.P. Corriou, Paris, hermès edition, 2001.
- [101] A. Sedoglavic. *Méthodes seminumériques en algèbre différentielle ; applications à l'étude des propriétés structurelles de systèmes différentiels algébriques en automatique*. PhD thesis, Ecole Polytechnique, 2001.
- [102] S. Sekhavat. *Planification de Mouvements sans Collision pour Systèmes non Holonomes*. PhD thesis, LAAS-CNRS, Toulouse, 1996.
- [103] H. Sira-Ramirez and M. Ilic-Spong. Exact linearization in switched-mode DC-to-DC power converters. *Int. J. Control*, 50:511–524, 1989.
- [104] W.M. Sluis. *Absolute Equivalence and its Application to Control Theory*. PhD thesis, University of Waterloo, Ontario, 1992.
- [105] W.M. Sluis. A necessary condition for dynamic feedback linearization. *Systems Control Letters*, 21:277–283, 1993.
- [106] M. Soroush and C. Kravaris. Multivariable nonlinear control of a continuous polymerization reactor. In *American Control Conference*, pages 607–614, 1992.
- [107] D. Tilbury, O. Sørдалen, L. Bushnell, and S. Sastry. A multisteering trailer system: conversion into chained form using dynamic feedback. *IEEE Trans. Robotics Automation*, 11(6):807, 1995.
- [108] D.M. Tilbury. *Exterior differential systems and nonholonomic motion planning*. PhD thesis, University of California, Berkeley, 1994. Memorandum No. UCB/ERL M94/90.
- [109] G. Valiron. *Equations Fonctionnelles*. Masson et Cie, Editeurs, Paris, 2nd edition, 1950.

- [110] M. van Nieuwstadt, M. Rathinam, and R. M. Murray. Differential flatness and absolute equivalence. *SIAM Journal of Control and Optimization*, 36(4):1225–1239, 1998.
- [111] M. J. van Nieuwstadt and R. M. Murray. Rapid hover to forward flight transitions for a thrust vectored aircraft. 21(1):93–100, 1998.
- [112] G. B. Whitham. *Linear and Nonlinear Waves*. John Wiley and Sons, Inc., 1974.
- [113] V.V. Zharinov. *Geometrical Aspects of Partial Differential Equations*. World Scientific, Singapore, 1992.