



HAL
open science

Plane Topology and Dynamical Systems

Boris Kolev

► **To cite this version:**

Boris Kolev. Plane Topology and Dynamical Systems. École thématique. Summer School "Systèmes Dynamiques et Topologie en Petites Dimensions", Grenoble, France, 1994, pp.35. cel-00719540

HAL Id: cel-00719540

<https://cel.hal.science/cel-00719540>

Submitted on 20 Jul 2012

HAL is a multi-disciplinary open access archive for the deposit and dissemination of scientific research documents, whether they are published or not. The documents may come from teaching and research institutions in France or abroad, or from public or private research centers.

L'archive ouverte pluridisciplinaire **HAL**, est destinée au dépôt et à la diffusion de documents scientifiques de niveau recherche, publiés ou non, émanant des établissements d'enseignement et de recherche français ou étrangers, des laboratoires publics ou privés.

Plane Topology and Dynamical Systems

Boris KOLEV

CNRS & Aix-Marseille University

Grenoble, France, June-July 1994

Summary. — These notes have been written for a Summer School, *Systèmes Dynamiques et Topologie en Petites Dimensions*, which took place at the Institut Fourier, in June-July 1994. The goal was to provide simple proofs for the Jordan and Schoenflies theorems and to give a short introduction to the theory of locally connected continua and indecomposable continua, with applications in Dynamical Systems and the theory of attractors.

E-mail : boris.kolev@cmi.univ-mrs.fr

Homepage : <http://www.cmi.univ-mrs.fr/~kolev/>

© This work is licensed under a [Creative Commons Attribution-NonCommercial-NoDerivs 3.0 Unported License](https://creativecommons.org/licenses/by-nc-nd/3.0/).



Chapter 1

The Jordan Curve Theorem

A homeomorphic image of a closed interval $[a, b]$ ($a < b$) is called an arc and a homeomorphic image of a circle is called a simple closed curve or a Jordan curve. To begin with, we recall first two simple facts about the plane.

1. If F is a closed set in \mathbb{R}^2 , any component of $\mathbb{R}^2 - F$ is open and arcwise connected. We will call these components, the *complementary domains* of F .
2. If K is a compact set in the plane \mathbb{R}^2 , then $\mathbb{R}^2 - K$ has exactly one unbounded component. We will refer to it as the unbounded or *exterior component* of K .

Assertion (1) follows from the local arcwise-connectedness of \mathbb{R}^2 and (2) from the boundedness of K .

Theorem 1.1 (Jordan Curve Theorem). *The complement in the plane \mathbb{R}^2 of a simple closed curve J consists of two components, each of which has J as its boundary. Furthermore, if J has complementary domains $\text{int}(J)$ (the bounded, or interior domain) and $\text{ext}(J)$ (the unbounded, or exterior domain), then $\text{Ind}(x, J) = 0$ if $x \in \text{ext}(J)$ and $\text{Ind}(x, J) = +1$ if $x \in \text{int}(J)$.*

Remark 1.2. Obviously, it follows from this statement that a simple closed curve divides the 2-sphere into exactly two domains, each of which it is the common boundary.

The proof we give here is due to Maehara [13] and uses as main ingredient the following well-known theorem of Brouwer.

Theorem 1.3 (Brouwer's Fixed Point Theorem). *Every continuous map of the closed unit disc D^2 into itself has a fixed point.*

Proof. We identify here the plane with the complex plane and let

$$D^2 = \{z \in \mathbb{C}; |z| \leq 1\}.$$

Suppose that $f : D^2 \rightarrow D^2$ has no fixed point. Then $f(z) \neq z$ for all $z \in D^2$ and the *degree*¹ of each map

$$f_t(z) = tz - f(tz), \quad z \in S^1, t \in [0, 1],$$

is well defined and all of them are equal. Since f_0 is a constant map we have $d(f_0) = 0$ and therefore $d(f_t) = 0$ for all $t \in [0, 1]$. But since $|z - f(z)|$ is strictly positive on the compact set S^1 , it is bounded below by a positive constant m and we get after an easy computation

$$\text{Re}((z - f(z))\bar{z}) > \frac{m^2}{2} > 0,$$

for all $z \in S^1$ so that $d(f_1) = d(\text{Id}_{S^1}) = 1$ which leads to a contradiction. \square

¹Each continuous map f of the circle with values in \mathbb{C} lift to a map $\tilde{f} : \mathbb{R} \rightarrow \mathbb{C}$ (angle determination) which satisfies $\tilde{f}(\theta + 2\pi) = \tilde{f}(\theta) + 2d\pi$. The integer d is called the degree of the map f . It is easily shown to not depend on the particular lift of f and to be a homotopy invariant.

Definition 1.4. Let X be any metric space and A a subspace of X . A continuous map $r : X \rightarrow A$ such that $r = Id$ on A is called a *retraction* of the space X on A .

As a corollary of theorem 1.3 (these two statements are in fact equivalent) we have the following.

Theorem 1.5 (No-Retraction Theorem). *There is no retraction of the unit disc D^2 onto its boundary S^1 .*

Proof. Suppose there exists a continuous map $r : D^2 \rightarrow S^1$ such that $r(z) = z$ for all $z \in S^1$ and let $s : S^1 \rightarrow S^1$ defined by $s(z) = -z$. Then the map $s \circ r : D^2 \rightarrow S^1 \subset D^2$ will be a continuous map without fixed points. \square

Let E denote the square $[-1, 1] \times [-1, 1]$ and $\Gamma = Fr(E)$ its boundary. A path γ in E is a continuous map $\gamma : [-1, 1] \rightarrow E$.

Lemma 1.6. *Let γ_1 and γ_2 be two paths in E such that γ_1 (resp. γ_2) joins the two opposite vertical (resp. horizontal) sides of E . Then γ_1 and γ_2 have a common point.*

Proof. Let $\gamma_1(s) = (x_1(s), y_1(s))$ and $\gamma_2(t) = (x_2(t), y_2(t))$ so that

$$x_1(-1) = -1, \quad x_1(1) = 1, \quad y_2(-1) = -1, \quad y_2(1) = 1.$$

If the two paths do not cross the function

$$N(s, t) = \max(|x_1(s) - x_2(t)|, |y_1(s) - y_2(t)|)$$

is strictly positive and the continuous map $f : E \rightarrow \Gamma \subset E$ defined by

$$f(s, t) = \left(\frac{x_2(t) - x_1(s)}{N(s, t)}, \frac{y_1(s) - y_2(t)}{N(s, t)} \right)$$

can easily be checked to have no fixed point which contradicts the Brouwer fixed point theorem (see [Exercise 1.1](#)). \square

Definition 1.7. A closed set F *separates* the plane \mathbb{R}^2 if $\mathbb{R}^2 - F$ has at least two components.

Lemma 1.8. *No arc α separates the plane.*

Proof. Suppose on the contrary that $\mathbb{R}^2 - \alpha$ is not connected. Then $\mathbb{R}^2 - \alpha$ has in addition to its unbounded component U_∞ at least one bounded component W . We have $Fr(U_\infty) \subset \alpha$ and $Fr(W) \subset \alpha$. Let $x_0 \in W$ and D be a closed disc with centre x_0 and radius R which contains W as well as α in its interior. By a straightforward application of the *Tietze extension theorem* (see [Exercise 1.2](#)) the identity map Id_α on α extends continuously to a retraction $r : D \rightarrow \alpha$. Let us define

$$q(x) = \begin{cases} r(x), & \text{if } x \in \bar{W}; \\ x, & \text{if } x \in W^c \cap D. \end{cases}$$

Then, $q : D \rightarrow D$ is a continuous map whose values lie in $D - \{x_0\}$. Hence, the composed map $p \circ q : D \rightarrow Fr(D)$ where

$$p(x) = R \frac{q(x) - x_0}{\|q(x) - x_0\|}$$

is a retraction of the disc D onto its boundary, contradicting the no-retraction theorem (theorem 1.5). \square

Remark 1.9. For further use, note that using the same arguments we can show that no 2-cell (that is the homeomorphic image of the unit square I^2) separates the plane.

Proof of Jordan's Theorem. We will divide the proof in three steps. First we will show that J separates the plane. Then we will prove that J is the boundary of each of its components and finally we will prove that the complement of J has exactly two components $int(J)$ and $ext(J)$ such that $Ind(x, J) = 0$ if $x \in ext(J)$ and $Ind(x, J) = \pm 1$ if $x \in int(J)$.

Step 1 : Since J is compact, there exist two points a, b in J such that $a - b = \text{diam}(J)$. We may assume that $a = (-1, 0)$ and $b = (1, 0)$. Then the rectangular set $E(-1, 1; -2, 2)$ contains J , and its boundary F meets J in exactly two points a and b . Let n be the middle point of the top side of E , and s the middle point of the bottom side. The segment \overline{ns} meets J by lemma 1.6.

Let l be the y -maximal point in $J \cap \overline{ns}$. Points a and b divide J into two arcs: we denote the one containing l by J_n and the other by J_s . Let m be the y -minimal point in $J_n \cap \overline{ns}$ then the segment \overline{ms} meets J_s ; otherwise, the path $\overline{nl} + \overline{lm} + \overline{ms}$, (where \overline{lm} denotes the subarc of J_n with end points l and m) could not meet J_s , contradicting lemma 1.6. Let p and q denote the y -maximal point and the y -minimal point in $J_s \cap \overline{ms}$, respectively. Finally, let x_0 be the middle point of the segment \overline{mp} (see Figure 1.1).

The choice of a homeomorphism $h : S^1 \rightarrow J$ permits us to define the index of a point with respect to J (it is well defined up to a sign). It is easy to see that $Ind(x, J) = 0$ for any point in the unbounded complementary domain $ext(J)$ of J . For fixing our ideas, we suppose now that we have oriented the curve J (resp. F) in such a way that we cross successively a, p and b (resp. a, s and b). Let Γ_n (resp. Γ_s) be the subarc of F delimited by a and b and containing n (resp. s). We set $\sigma_n = \Gamma_n - J_n$ (meaning we follow Γ_n , and then J_n with the reversed orientation) and $\sigma_s = -J_s + \Gamma_s$. Since the half line x_0s does not meet σ_n , we have $Ind(x_0, \sigma_n) = 0$. By a similar argument $Ind(x_0, \sigma_s) = 0$ and since

$$\Gamma = \sigma_n + J + \sigma_s,$$

we have

$$Ind(x_0, J) = Ind(x_0, \sigma_n) + Ind(x_0, J) + Ind(x_0, \sigma_s) = Ind(x_0, \Gamma) = 1.$$

Therefore, $x_0 \notin ext(J)$ and J separates the plane.

Step 2 : Let U be any complementary domain of J and x a point in U . Note that $Fr(U) \subset J$. Therefore, if $Fr(U) \subset J$, there is an arc α which contains entirely $Fr(U)$. Because J separates the plane, there is a point $y \in \mathbb{R}^2 - J$ such that x and y are separated by $Fr(U)$ hence by α which contradicts lemma 1.8. Thus $Fr(U) = J$.

Step 3 : Let U be the component of the point x_0 defined in (1). Suppose that there exists another bounded component $W (\neq U)$ of $\mathbb{R}^2 - J$. Clearly $W \subset E$. We denote by β the path $\overline{nl} + \overline{lm} + \overline{mp} + \overline{pq} + \overline{qs}$, where \overline{pq} is the subarc of J_s , from p to q . Hence, β has no point of W . Since a and b are not on β , there are circular neighborhoods V_a and V_b , of a and b , respectively, such that each of them contains no point of β . But $Fr(W) = J$, so there exist $a_1 \in W \cap V_a$ and $b_1 \in W \cap V_b$. Let $\overline{a_1b_1}$ be a path in W from a_1 to b_1 . Then the path $\overline{aa_1} + \overline{a_1b_1} + \overline{bb_1}$ fails to meet β . This contradicts lemma 1.6 and completes the proof. \square

Remark 1.10. Let J be a simple closed curve in the (oriented) plane. Then $Ind(x, J) = 1$ for all points in $int(J)$ or $Ind(x, J) = -1$ for all points in $int(J)$. In the first case we will say that J is *positively* oriented otherwise it is *negatively* oriented.

From now on, a subset D of the plane will be called a *disc* if it is the bounded complementary domain of a simple closed curve J .

U being any connected open set of the plane, a *cross-cut* in U is a simple arc $L \subset U$ which intersects $Fr(U)$ in exactly its two endpoints. If just one of the endpoints of L meets $Fr(U)$, then L is called an *end-cut*. A point a of $Fr(U)$ which is the endpoint of an end-cut in U is called *accessible* from U . We will prove later that every point of a simple closed curve is accessible from both of its complementary domains.

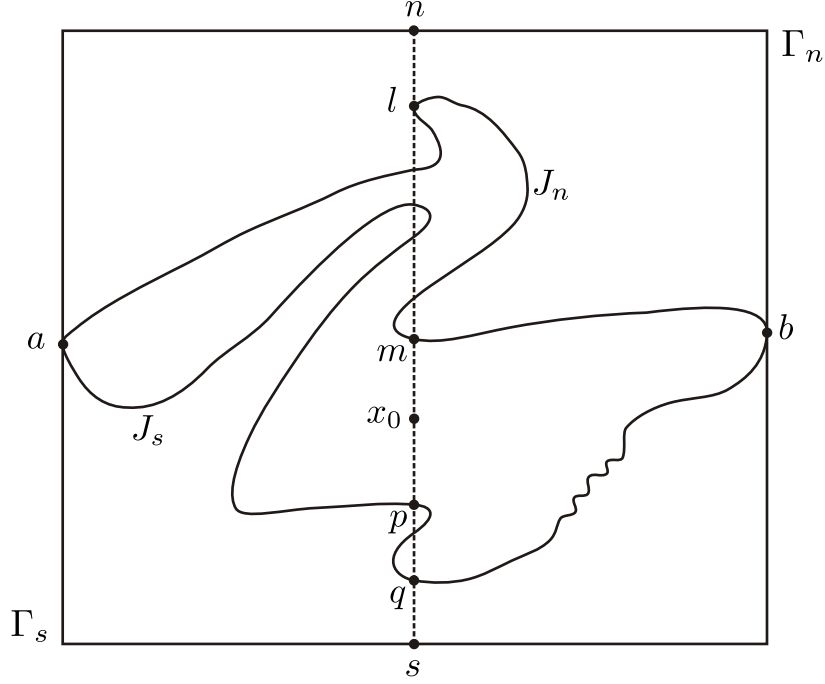

Figure 1.1: A Jordan curve

Lemma 1.11 (θ -curve Lemma). *Let J be a simple closed curve in the plane. A cross-cut L in $\text{int}(J)$ divides $\text{int}(J)$ into exactly two domains. If L_1 and L_2 are the subarcs of J defined by the endpoints a and b of L , these two domains are the discs $\text{int}(L \cup L_1)$ and $\text{int}(L \cup L_2)$.*

Proof of θ -curve Lemma. If X denotes one of the sets $\text{ext}(J)$, $\text{int}(L \cup L_1)$ or $\text{int}(L \cup L_2)$ then $\text{Fr}(X) \subset J \cup L$. Hence,

$$\overline{X} \cap (\mathbb{R}^2 - (J \cup L)) = X \cap (\mathbb{R}^2 - (J \cup L)).$$

Therefore, X is open and closed in $\mathbb{R}^2 - (J \cup L)$ and is a component of $\mathbb{R}^2 - (J \cup L)$. We are going to show that

$$\mathbb{R}^2 - (J \cup L) = \text{ext}(J) \cup \text{int}(L \cup L_1) \cup \text{int}(L \cup L_2).$$

Suppose on the contrary that there exists another component U distinct from the three above. Then $\text{Fr}(U)$ must meet each of the three (open) arcs L° , L_1° , L_2° . Indeed, if $\text{Fr}(U \cap L^\circ) = \emptyset$, then $\text{Fr}(U) \subset J$ and $\overline{U} \cap (\mathbb{R}^2 - J) = U \cap (\mathbb{R}^2 - J)$. Hence U is open and closed in $\mathbb{R}^2 - J$ and $U = \text{int}(J) \supset L^\circ$, which gives a contradiction. Similarly, if $\text{Fr}(U) \cap L_1^\circ = \emptyset$, then U is open and closed in $\mathbb{R}^2 - (L \cup L_2)$ and thus $U = \text{ext}(L \cup L_2) \supset L_1^\circ$ which also gives a contradiction.

Therefore, we can construct a cross-cut μ in U with endpoints $u_1 \in L_1^\circ$ and $u_2 \in L_2^\circ$. We can also construct a cross-cut ν in $\text{ext}(J)$ with endpoints v_1 and v_2 , where v_1 and v_2 belong to two non adjacent arcs among those of $J - \{a, u_1, b, u_2\}$. Let K denote the simple closed curve

$$K = \mu \cup \widehat{u_1 v_1} \cup \nu \cup \widehat{u_2 v_2}$$

where $\widehat{u_1 v_1} \subset L_1^\circ$ and $\widehat{u_2 v_2} \subset L_2^\circ$. We are therefore in the following situation (see [Figure 1.2](#)).

1. $K \cap L = \emptyset$ (since $\mu \subset U \subset \mathbb{R}^2 - L$).
2. Each complementary domain of K meets $\text{int}(J)$ and $\text{ext}(J)$ and hence J (since $\mu^\circ \subset \text{int}(J)$ and $\nu^\circ \subset \text{ext}(J)$).

3. The two arcs of $J - K$ are connected by L and are therefore in one complementary domain R of K .
4. $Fr(R) = K \supset \widehat{u_i v_i}$ ($i = 1, 2$).

It follows from assertions (3) and (4) that $J \subset R$ which is a contradiction with assertion (2) (each complementary domain of K meets J). \square

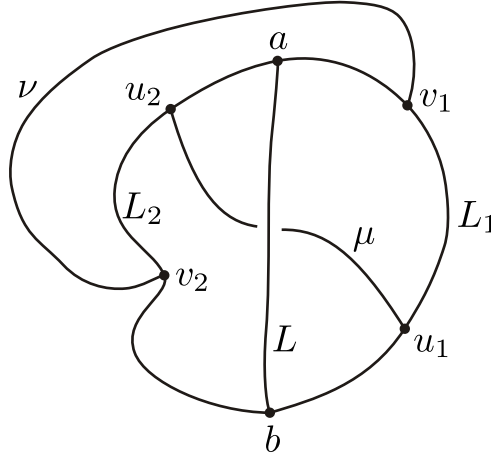

Figure 1.2: A θ -curve

Theorem 1.12 (Invariance of Domain). *Let U be an open set in the plane and $f : U \rightarrow \mathbb{R}^2$ be a one-to-one and continuous map. Then $f(U)$ is an open set of \mathbb{R}^2 .*

Remark 1.13. This theorem is not to be confused with the proposition that if \mathbb{R}^2 is mapped by a homeomorphism onto itself, open sets are mapped onto open sets, which follows immediately from the definition of a homeomorphism. In this theorem, it is not assumed that the map f is defined outside U , nor that there exists a homeomorphism of the whole space on to itself coinciding with the given one in U .

The proof of this theorem is an immediate application of the following Lemma. As usual D^2 is the closed unit disc and S^1 its boundary.

Lemma 1.14. *Let $f : D^2 \rightarrow \mathbb{R}^2$ be a continuous and one-to-one map. Then $f(int(D^2)) = int(f(S^1))$.*

Proof. Let $A = f(D^2)$ and $J = f(S^1)$. Then A is a closed 2-cell and J is a simple closed curve. $f(int(D^2))$ is a connected set which does not meet J and is therefore contained in a complementary domain R of J . If $f(int(D^2)) \neq R$, there are some points of $\mathbb{R}^2 - A$ in both components of $\mathbb{R}^2 - J$ and hence on J since $\mathbb{R}^2 - A$ is connected (see remark 1.9). But this is impossible since $J \subset A$. Therefore, $f(int(D^2)) = R = int(J)$ (since $f(int(D^2))$ is bounded). \square

The following corollaries of theorem 1.12 are straightforward and their proof will be omitted.

Corollary 1.15. *Let U an open subset of the plane and $f : U \rightarrow \mathbb{R}^2$ be a continuous and one-to-one map. Then f is a homeomorphism of U onto the open set $f(U)$.*

Corollary 1.16. *Let f be any homeomorphism between two plane sets A and B . Then $f(int(A)) = int(B)$. Hence, if A and B are closed set $f(Fr(A)) = Fr(B)$.*

The next application of the Jordan Curve Theorem is due to Keréjártó [10, 16].

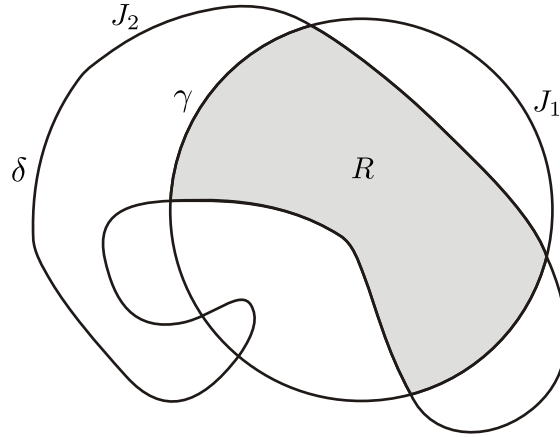

Figure 1.3: The intersection of two discs

Lemma 1.17 (Kerékjártó). *Each component of the intersection of two (open) discs D_1 and D_2 is a disc.*

Proof. If $D_1 \cap D_2 = \emptyset$, there is nothing to prove. Otherwise, let R be a component of $D_1 \cap D_2$ and set $J_i = Fr(D_i)$ for $i = 1, 2$. It is clear that $Fr(R) \subset J_1 \cup J_2$. If $Fr(R) \subset J_i$ for some i , then R is open and closed in $\mathbb{R}^2 - J_i$ hence $R = D_i$ and the Lemma is proved. Thus, we may assume that $Fr(R) \not\subset J_i$ for $i = 1, 2$. Let $x \in Fr(R)$, $x \notin J_2$. Then $x \in J_1 \cap D_2$, and we can find an arc γ in J_1 such that $x \in \gamma^\circ$ and

$$\gamma^\circ \subset D_2, \quad \gamma \subset Fr(R), \quad \partial\gamma \subset J_1 \cap J_2.$$

$J_2 \cup \gamma$ is a θ -curve and R belongs to one of the complementary domains of $\mathbb{R}^2 - \theta$. Thus, the endpoints of γ define an arc δ on J_2 which doesn't meet R and such that $\delta \cap Fr(R) = \partial\delta$ (see Figure 1.3).

There is at most a countable family of such arcs γ_n and $\text{diam}(\gamma_n) \rightarrow 0$ as $n \rightarrow \infty$ (see Exercise 2.1). The corresponding arcs δ_n° are pairwise disjoint (again an application of the θ -curve lemma) and therefore $\text{diam}(\delta_n) \rightarrow 0$ as $n \rightarrow \infty$ as well. Let J be the simple closed curve obtained from J_2 by substituting to each arc δ_n the corresponding arc γ_n of J_1 . It is then easy to verify that $Fr(R) \subset J$ and therefore $Fr(R) = J$ since $Fr(R)$ separates the plane but no proper closed subset of J does. Thus $Fr(R)$ is a simple closed curve and R is a disc. \square

Exercises

Exercise 1.1. Let $K \neq \emptyset$ be a compact and convex set in the plane and $f : K \rightarrow K$ a continuous map. Deduce from Brouwer's Fixed Point Theorem that f has at least one fixed point.

Exercise 1.2 (Tietze's Extension Theorem). Let F be a non empty closed set of a metric space (X, d) and $f : F \rightarrow I = [0, 1]$ be a continuous map. Define $\bar{f} : X \rightarrow I$ by $\bar{f}(x) = f(x)$, if $x \in F$ and

$$\bar{f}(x) = \sup_{y \in F} \frac{d(x, F)}{d(x, y)} f(y)$$

if $x \in X - F$. Prove that \bar{f} is continuous. Extend the result when $f : F \rightarrow I^n$, ($n \geq 1$).

Exercise 1.3. Let U be a connected open set in the plane. Prove that the accessible points of the boundary of U are dense in $Fr(U)$.

Exercise 1.4. There is no homeomorphism from the 2-sphere onto one of its proper subset.

Exercise 1.5. If $n \neq 2$, \mathbb{R}^2 and \mathbb{R}^n are not homeomorphic.

Exercise 1.6. Let K be a compact set and F a closed set in the plane with $K \cap F = \emptyset$. Let $a \in K$ and $b \in F$. Show that for any $\varepsilon > 0$, there exists a simple closed curve J in $\mathbb{R}^2 - (K \cup F)$ which separates a and b and such that $J \subset V_\varepsilon(K)$.

Exercise 1.7. Deduce from [Exercise 1.6](#) the following statements. The boundary of every bounded simply connected domain in the plane is connected. The boundary of each complementary domain of a compact subset of the plane is connected.

Chapter 2

The Schoenflies Theorem

The aim of this section is to prove the famous theorem of Schoenflies which asserts that any homeomorphism of the unit circle S^1 onto a simple closed curve J can be extended to the whole plane. To do this, we now introduce an auxiliary notion which generalizes the concept of θ -curve.

Definition 2.1. The sum $L_0 \cup L_1 \cup \cdots \cup L_n$, of $n + 1$ ($n \geq 1$) arcs in the plane is called a network when:

1. $L_0 \cup L_1$ is a simple closed curve,
2. $L_k \cap (L_0 \cup L_1 \cup \cdots \cup L_{k-1})$ consists of just the endpoints of L_k , for $k = 1, 2, \dots, n$.

The network $\Gamma_n = L_0 \cup L_1 \cup \cdots \cup L_n$, extends $\Gamma_m = L_0 \cup L_1 \cup \cdots \cup L_m$ if $m < n$ and we write then $\Gamma_m \prec \Gamma_n$.

Lemma 2.2. *The set $\mathbb{R}^2 - (L_0 \cup L_1 \cup \cdots \cup L_n)$ has exactly n distinct bounded components, each of them is a disc whose boundary lies in $L_0 \cup L_1 \cup \cdots \cup L_n$.*

Proof. For $n = 1$ it is just Jordan's Curve Theorem and for $n = 2$, the θ -curve Lemma. So, let us suppose that the Lemma is true for some $n > 2$ and let D_1, D_2, \dots, D_n , be the bounded components of $\bar{D} - (L_0 \cup L_1 \cup \cdots \cup L_n)$. Let L_{n+1} be an arc such that $L_{n+1} \cap (L_0 \cup L_1 \cup \cdots \cup L_n) = \partial L_{n+1}$. Without loss of generality we can suppose that L_{n+1}° lies in D_n . By the θ -curve Lemma, we know that L_{n+1} divides D_n into exactly two discs D_n^+ and D_n^- and $Fr(D_n^\pm) \subset Fr(D_n) \cup L_{n+1}$, which proves the theorem. \square

Let $J = L_0 \cup L_1$ be a simple closed curve which bounds a disc D and $\Gamma = L_0 \cup L_1 \cup \cdots \cup L_n$, an extension of J such that $L_k \subset \bar{D}$ for $k = 0, \dots, n$. Then each bounded complementary domain D_k ($k = 1, \dots, n$) of Γ is a subset of D and $\bar{D} = \bigcup_{k=1}^n \bar{D}_k$. We will call the finite collection $\{\bar{D}_1, \dots, \bar{D}_n\}$ a subdivision of \bar{D} and we will say that Γ subdivides \bar{D} . The number

$$m(\Gamma) = \max \{ \text{diam}(D_k); k = 1, \dots, n \}$$

will be called the *mesh* of Γ .

Lemma 2.3. *Let J be a simple closed curve bounding a disc D and $\varepsilon > 0$. Then there exists a subdivision of \bar{D} by a network Γ of mesh less than ε .*

Proof. Consider the family \mathcal{V} of vertical lines

$$V_k = \{(x, y); x = k\varepsilon/2\}, \quad (k \in \mathbb{Z}).$$

Only a finite number of these lines meet D (since D is bounded). If V_k meets D , then $V_k \cap D$ is the union of an at most countable family of pairwise disjoint segments (I_n^k) with $\text{diam}(I_n^k) \rightarrow 0$ as $n \rightarrow +\infty$.

Let $\delta > 0$ be such that any two points of J with distance less than δ determine an arc on J of diameter less than $\varepsilon/4$ (see [Exercise 2.1](#)). Denote L_2, \dots, L_p those of the segments (I_n^k) such that $\text{diam}(I_n^k) \geq \delta$ and let $\Gamma_1 = J \cup L_2 \cup \dots \cup L_p$. Then each of the bounded complementary domains of Γ_1 is contained in the union of at most 3 adjacent vertical strips.

Indeed, suppose on the contrary that there exists a bounded complementary domain of Γ_1 say D_1 which meets three consecutive vertical lines V_{k-1}, V_k, V_{k+1} . Let a (resp. b) a point of $V_{k-1} \cap D_1$ (resp. $V_{k+1} \cap D_1$). Choose a polygonal arc γ (with no vertical segments!) which joins a and b in D_1 . This arc meets V_k in a finite number of points which belong to some segments $I_{n_1}^k, \dots, I_{n_r}^k$ defined above. It is then easy to show by induction on r that at least one of these segments say $I_{n_1}^k$ separates the two points a and b in D . But $d(a, V_k) = d(b, V_k) = \varepsilon/2$ so that

$$\text{length}(I_{n_1}^k) \geq \delta,$$

which leads to a contradiction.

Next, we do the same construction with the family \mathcal{H} of horizontal lines $H_k : y = k \cdot \varepsilon/2$ ($k \in \mathbb{Z}$) and we extend Γ_1 into a network Γ by adding horizontal segments L_{p+1}, \dots, L_q such that each bounded complementary domain of Γ lies in the union of 3 horizontal strips. By this way we have constructed a network Γ which subdivides \bar{D} , of mesh less than 3ε . \square

Definition 2.4. A metric space X is *uniformly locally connected* provided that for any $\varepsilon > 0$ there exists $\delta > 0$ so that any two points of X with distance $d(x, y) < \delta$ are contained in a connected subset of diameter less than ε .

Corollary 2.5. *The interior of any simple closed is uniformly locally connected.*

Proof. Let J be a simple closed curve, D its bounded complementary domain and $\varepsilon > 0$ (we can suppose $2\varepsilon < \text{diam}(J)$). By the above Lemma, we can find a network Γ of mesh $< \varepsilon$ with subdivides \bar{D} . Since $2\varepsilon < \text{diam}(J)$ there exists i, j such that $\bar{D}_i \cap \bar{D}_j = \emptyset$ (where D_1, \dots, D_n are the bounded complementary domains of Γ). Therefore,

$$\delta = \min \{d(\bar{D}_i, \bar{D}_j); \quad \bar{D}_i \cap \bar{D}_j = \emptyset\} > 0.$$

It is then easy to verify that two points of D with distance less than δ can be joined in D by an arc of diameter less than 2ε . Indeed, if \bar{D}_i and \bar{D}_j meet J then \bar{D}_i and \bar{D}_j have a common arc or their intersection is empty. \square

Corollary 2.6. *A simple closed curve J is accessible from both of its complementary domains.*

Proof. We are going to show first that every point of J is accessible from $D = \text{int}(J)$. Let a be any point of J and for each $n = 1, 2, \dots$, let $\delta_n > 0$ so that any two points in $B(a, \delta_n) \cap D$ can be joined by a polygonal arc in $B(a, 1/n) \cap D$.

For each n choose a point $x_n \in B(a, \delta_n) \cap \text{int}(J)$ and then a polygonal arc γ_n , joining x_n , and x_{n+1} in $B(a, 1/n) \cap D$. We define this way, a sequence of linear segments $s_n = a_n a_{n+1}$ such that $s_n \cap s_{n+1} \neq \emptyset$ for all $n \geq 1$ and $\lim(a_n) = a$. By subdividing some of the segments, we can suppose that if $s_i \cap s_j \neq \emptyset$ and $s_i \neq s_j$, then $s_i \cap s_j$ is reduced to a common endpoint of s_i and s_j . Hence, we define an end-cut γ connecting x_1 and a in $\text{int}(J)$ by the following. First, we define $k_0 = \max \{i; x_1 \in s_i\}$ and inductively, $k_{n+1} = \max \{i; s_i \cap s_{k_n} \neq \emptyset\}$. Then we set

$$\gamma(t) = \begin{cases} s_{k_0}, & \text{if } t \in [0, 1/2]; \\ s_{k_n}, & \text{if } t \in [1/2^n, 3/2^{n+1}); \\ a, & t=1. \end{cases}$$

The accessibility from $\text{ext}(J)$ follows from the following observation. A fractional linear transformation h of the two sphere $\mathbb{R}^2 \cup \{\infty\}$ which permutes a point $x_0 \in \text{int}(J)$ and ∞ , sends $\text{ext}(J)$ onto $\text{int}(h(J)) - \{x_0\}$. \square

Using similar arguments, we can show that the complement of an arc in the plane is also uniformly locally connected. In particular the endpoints of an arc are accessible from its complementary domain and we get the following result.

Lemma 2.7. *Each arc of the plane lies in a simple closed curve.*

A homeomorphism $h : \Gamma \rightarrow \Gamma^*$ between two networks is *regular* if it is possible to index the bounded complementary domains of Γ (resp. Γ^*) by D_1, \dots, D_n , (resp. D_1^*, \dots, D_n^*) in such a way that:

$$h(\text{Fr}(D_i)) = \text{Fr}(D_i^*), \quad i = 1, \dots, n.$$

In that case we get also that $h(\text{Fr}(D_0)) = \text{Fr}(D_0^*)$ where D_0 (resp. D_0^*) is the unbounded complementary domain of Γ (resp. Γ^*) (see [Exercise 2.2](#)).

Lemma 2.8. *Let Γ_0 and Γ_1 be two networks where Γ_1 extends Γ_0 . Then any regular homeomorphism h_0 between Γ_0 and a network Γ_0^* can be extended into a regular homeomorphism h_1 between Γ_1 and an extension Γ_1^* of Γ_0^* .*

Proof. It is enough to prove the Lemma when $\Gamma_1 = \Gamma_0 \cup L$ where L is a simple arc. Let a, b be the endpoints of L , hence $L \cap \Gamma_0 = \{a, b\}$. Without loss of generality, we can suppose that $L \subset \bar{D}_n$ so that $\{h(a), h(b)\} \subset \text{Fr}(D_n^*)$. By corollary 2.6 we can construct a cross-cut L^* in D_n^* connecting the points $h(a)$ and $h(b)$. Hence we can extend h on Γ_1 by defining $h_1(L) = L^*$. Next, we let $E_k = D_k$, $E_k^* = D_k^*$ for $k < n$. Then we denote by E_n and E_{n+1} the two components of $D_n - L$ (resp. $D_n^* - L^*$) indexed in such a way that $h_1(\text{Fr}(E_i)) = \text{Fr}(E_i^*)$ for $i = n, n+1$. \square

Remark 2.9. In the case where $\Gamma_1 = \Gamma_0 \cup L$, we have

$$h_1(\Gamma_1 \cap \bar{D}_i) \subset \bar{D}_i^*, \quad \text{for } i = 0, \dots, n.$$

This is also true by induction in the general case.

Theorem 2.10 (Schoenflies Theorem). *Let J and K be simple closed curves. Then any homeomorphism $h : J \rightarrow K$ can be extended to give a homeomorphism of $\text{int}(J) \cup J$ onto $\text{int}(K) \cup K$.*

Proof. We are going to construct inductively two sequences of networks

$$\Gamma_0 \prec \Gamma_1 \prec \dots \quad \Gamma_0^* \prec \Gamma_1^* \prec \dots$$

and two sequences of regular homeomorphisms $h_n : \Gamma_n \rightarrow \Gamma_n^*$ and $h_n^* : \Gamma_n^* \rightarrow \Gamma_n$ which are the inverse of each other and such that $m(\Gamma_n) < 1/n$, $m(\Gamma_n^*) < 1/n$ and Γ_n (resp. Γ_n^*) subdivides $\bar{D}_J = \text{int}(J) \cup J$ (resp. $\bar{D}_K = \text{int}(K) \cup K$).

We set $\Gamma_0 = J$, $\Gamma_0^* = K$ and $h_0 = h$. Assume inductively that Γ_n , Γ_n^* and h_n have already been defined so that h_n is a regular homeomorphism of Γ_n onto Γ_n^* with inverse h_n^* and that Γ_n and Γ_n^* subdivide \bar{D}_J and \bar{D}_K respectively.

If n is even, we construct a subdivision Γ_{n+1} of \bar{D}_K with $\Gamma_n^* \prec \Gamma_{n+1}^*$ and $m(\Gamma_{n+1}^*) < 1/(n+1)$. We then extend h_n^* into a regular homeomorphism $h_{n+1}^* : \Gamma_{n+1}^* \rightarrow \Gamma_{n+1} = h_{n+1}^*(\Gamma_{n+1}^*)$ by virtue of lemma 2.8.

If n is odd we do the same construction but we extend first this time Γ_n into Γ_{n+1} with $m(\Gamma_{n+1}) < 1/(n+1)$.

Then we set $\Gamma = \bigsqcup_n \Gamma_n$, and $\Gamma^* = \bigsqcup_n \Gamma_n^*$, and define $h : \Gamma \rightarrow \Gamma^*$ (resp. $h^* : \Gamma^* \rightarrow \Gamma$) by $h(x) = h_n(x)$ if $x \in \Gamma_n$ (resp. $h^*(x) = h_n^*(x)$ if $x \in \Gamma_n^*$). Then h (resp. h^*) is uniformly continuous. Indeed, let $\varepsilon > 0$ and $n > 0$ be such that $1/n < \varepsilon$. Let D_1, \dots, D_{p_n} be the bounded complementary domains of Γ_n and set

$$\delta_n = \min \{d(\bar{D}_i, \bar{D}_j); \quad \bar{D}_i \cap \bar{D}_j = \emptyset\}$$

δ_n is defined for n large enough). Then recalling that $h(\Gamma \cap \bar{D}_i) \subset \Gamma^* \cap \bar{D}_i^*$, it is straightforward to show that for any two points of Γ with distance less than δ_n , we have $d(h(x), h(y)) < 2\varepsilon$.

Since Γ is dense in \bar{D}_J , h extends uniquely to a continuous map $h : \bar{D}_J \rightarrow \bar{D}_K$. Similarly h^* extends to a map $h^* : \bar{D}_K \rightarrow \bar{D}_J$ and we get $h \circ h^* = Id$ and $h^* \circ h = Id$ which completes the proof. \square

Corollary 2.11. *Let J and K be simple closed curves. Then any homeomorphism $h : J \rightarrow K$ can be extended into a homeomorphism $h : \mathbb{R}^2 \rightarrow \mathbb{R}^2$ which is the identity outside a compact set.*

Proof. We can suppose that $K = S^1$ and that the origin O belongs to $int(J)$. Then, we choose a circle C such that J and S^1 are contained in $int(C)$.

The half line Ox^- meets J a last time at a point a before meeting C at a point a' and the half line Ox^+ meets J a last time at a point b before meeting C at a point b' . Let L_0 and L_1 be the two arcs of J defined by a and b and $L_i^* = h^{-1}(L_i)$ ($i = 0, 1$).

We choose two disjoint arcs L_a^* and L_b^* in the annulus defined by S^1 and C so that L_a^* joins $h^{-1}(a)$ and a' and L_b^* joins $h^{-1}(b)$ and b' (see Figure 2.1). Then, we extend h by $h(L_a^*) = \overline{aa'}$, $h(L_b^*) = \overline{bb'}$ and by the identity on C . This extension of h is a regular homeomorphism between the two networks

$$C \cup L_a^* \cup L_0^* \cup L_b^* \cup L_1^*,$$

and

$$C \cup \overline{aa'} \cup L_0 \cup \overline{bb'} \cup L_1.$$

Now by Schoenflies theorem, it can be extended into a homeomorphism of the closed disc bounded by C . Since $h = Id$ on C , we can then extend h to the whole plane by letting $h = Id$ on $ext(C)$. \square

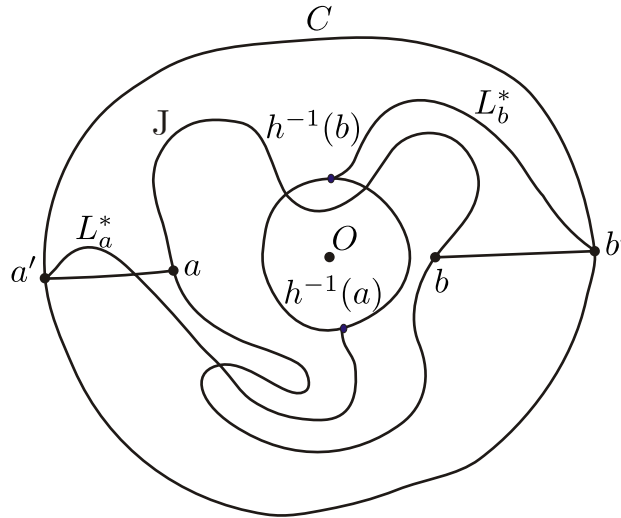

Figure 2.1:

Remark 2.12. In fact we have also proved that if J and K are two simple closed curve such that $J \subset int(K)$, there exists a homeomorphism of the plane (with compact support) sending $int(K) \cap ext(J)$ onto the annulus

$$A = \{(x, y) \in \mathbb{R}^2; 1 \leq x^2 + y^2 \leq 2\}.$$

Let $h : \mathbb{R} \rightarrow \mathbb{R}^2$ be a proper embedding and $L = h(\mathbb{R})$. The closure of L in the extended plane $\mathbb{R}^2 \cup \{\infty\}$ is a simple closed curve and therefore:

Corollary 2.13. Any proper embedding $h : \mathbb{R} \rightarrow \mathbb{R}^2$ can be extended into a homeomorphism of the whole plane.

Since any arc of the plane belongs to a simple closed curve (lemma 2.7), we also get:

Corollary 2.14. Any homeomorphism $h : [0, 1] \rightarrow \alpha \subset \mathbb{R}^2$ can be extended to a homeomorphism of the whole plane (with compact support).

We suppose now that we have oriented the plane. Let $f : U \rightarrow V$ be a homeomorphism between two open sets of the plane. Choose a point $a \in U$ and $\varepsilon > 0$ with $B(a, \varepsilon) \in U$ and let J be any simple closed curve with $a \in \text{int}(J)$ and $J \subset B(a, \varepsilon)$.

From Schoenflies theorem we know that $\bar{D}_J = \text{int}(J) \cup J$ is a 2-cell and from theorem 1.12 we know that the inner domain of J is mapped by f onto the inner domain of $f(J)$. Hence there exists $e \in \{-1, +1\}$ such that

$$\text{Ind}(f(a), f(J)) = e \text{Ind}(a, J).$$

The number e is independent of the choice of J since two simple closed curves, J and both containing a in their inner domain and both contained in $B(a, \varepsilon)$ are isotopic in $U - \{a\}$. The number $e = d(a, f)$ is the degree of f at a . Since $a \mapsto d(a, f)$ is locally constant it is constant on any domain.

Definition 2.15. We say that a homeomorphism $f : U \rightarrow V$ between two domains is *orientation-preserving* or *orientation-reversing* according to $d(f)$ is $+1$ or -1 .

This definition extends easily when U and V are two oriented connected 2-dimensional topological manifolds or when f is an embedding.

Exercises

Exercise 2.1. Let J be a simple closed curve. Prove that for all $\varepsilon > 0$, there exists $\delta > 0$ such that if x and y are two distinct points such that $d(x, y) < \delta$ then at least one of the two arcs of J delimited by x and y has diameter $< \varepsilon$. Give and prove a similar statement for a simple arc.

Exercise 2.2. Let $h : \Gamma \rightarrow \Gamma^*$ be a regular homeomorphism and D_0 (resp. D_0^*) be the unbounded component of Γ (resp. Γ^*). Show that $f(\text{Fr}(D_0)) = \text{Fr}(D_0^*)$.

Exercise 2.3. Let $f : U \rightarrow V$ be a C^1 diffeomorphism between two open set in the plane. Show that $d(a, f) = +1$ if $\det[f'(a)] > 0$ and $d(a, f) = -1$ if $\det[f'(a)] < 0$.

Chapter 3

Locally Connected Continua

Definition 3.1. A *continuum* is a nonempty, compact, connected metric space. It is non degenerate provided it contains more than one point.

A point x of a continuum X is a cut point of X if $X - \{x\}$ is not connected. If Y is any subset of X , the notation $Y = U|V$ means that $Y = U \cup V$ is a partition of Y into two nonempty sets both open and closed in Y . The proof of the following statement is straightforward and will be omitted.

Lemma 3.2. *If x is a cut point of a continuum X and $X - \{x\} = U|V$, then $\bar{U} = U \cup x$, $\bar{V} = V \cup x$ and \bar{U}, \bar{V} are both sub-continua of X .*

Lemma 3.3. *Let X be a nondegenerate continuum. If X has a cut point x and $X - \{x\} = U|V$, then both of U and V contain a non-cut point of X . In particular every nondegenerate continuum has at least two non-cut points.*

Proof. Suppose that U contains only cut points of X and choose a countable dense set in X ,

$$E = \{x_n; n \in \mathbb{N}\}.$$

Let n_1 be the first index n for which $x_n \in U$. Since x_{n_1} is a cut point, we can find two open sets U_1 and V_1 such that

$$X - \{x_{n_1}\} = U_1 \cup V_1, \quad x \in V_1$$

so that $\bar{U}_1 = U_1 \cup \{x_{n_1}\} \subset U = U_0$.

Assume inductively that x_{n_k}, U_k and V_k have already been defined with $\bar{U}_k \subset U_{k-1}$. Then we let n_{k+1} be the smallest integer n so that $x_n \in U_k$ and we choose two open sets U_{k+1} and V_{k+1} such that $X - \{x_{n_{k+1}}\} = U_{k+1}|V_{k+1}$ with $x_k \in V_{k+1}$ and hence $\bar{U}_{k+1} \subset U_k$.

Then we set

$$K = \bigcap_{n \geq 0} \bar{U}_n = \bigcap_{n \geq 0} U_n$$

and choose a point $x_\infty \in K$. We can find two open sets U_∞ and V_∞ such that $X - \{x_\infty\} = U_\infty|V_\infty$. Since $x_\infty \neq x_{n_k}$ for all $k \geq 1$, there is an infinity of values of k for which, say, $x_{n_k} \in V_\infty$ and so $\bar{U}_\infty = U_\infty \cup \{x_\infty\} \subset U_k$. Hence $\bar{U}_\infty \subset K$. But then, since U_∞ is a nonempty open set, there must be a point $x_m \in U_\infty$ which leads to a contradiction since K has been constructed so that it contains no point of E . \square

Theorem 3.4. *A continuum X is an arc if it has only two non-cut points*

Proof. Denote by a and b the two non-cut points of X . It follows from lemma 3.3 that if $x \in X - \{a, b\}$, then we can find two open sets $A_x \ni a$ and $B_x \ni b$ with $X - \{x\} = A_x|B_x$. It is then easy to check that for any two such decompositions $X - \{x\} = A_x|B_x$ and $X - \{y\} = A_y|B_y$ where x and y are distinct points, we have:

- $y \in B_x \Rightarrow \bar{A}_x \subset A_y$ and $\bar{B}_y \subset B_x$,
- $y \in A_x \Rightarrow \bar{A}_y \subset A_x$ and $\bar{B}_x \subset B_y$.

From this it follows first that the sets \bar{A}_x and \bar{B}_x are uniquely defined for all $x \in X - \{a, b\}$ and that we define a simple ordering on X if we set:

1. $x \prec b$, for all $x \in X - \{b\}$,
2. $x \prec a$, for all $x \in X - \{a\}$,
3. $x \prec y$, if and only if $y \in B_x$, for all $x, y \in X - \{a, b\}$.

Moreover, if x and y are any two points of X such that $x \prec y$, then there exists $z \in X$ so that $x \prec z \prec y$.

Choose a countable dense set $\{x_1, x_2, \dots\} \subset X$. An order preserving homeomorphism $h : [0, 1] \rightarrow X$ can now be constructed inductively as follows. We set $h(0) = a$ and $h(1) = b$. For each dyadic fraction $0 < m/2^k < 1$ with m odd, let us assume inductively that $h((m-1)/2^k)$ and $h((m+1)/2^k)$ have already been defined. Then choose the smallest index j so that

$$h\left(\frac{m-1}{2^k}\right) \prec x_j \prec h\left(\frac{m+1}{2^k}\right)$$

and set $h(m/2^k) = x_j$. It is not difficult to show that the h constructed in this way on dyadic fractions extends uniquely to an order preserving map from $[0, 1]$ to X , which is necessarily a homeomorphism. \square

Corollary 3.5. *A nondegenerate continuum whose connection is destroyed by the removal of two arbitrary points is a simple closed curve.*

Proof. Let x and y be two non-cut points of X and choose two open sets U and V so that $X - \{x, y\} = U \cup V$. First, it is straightforward to check that $\bar{U} = U \cup \{x, y\}$, $\bar{V} = V \cup \{x, y\}$ that there are both connected. We are going to show that \bar{U} and \bar{V} are both arcs with endpoints x, y and hence $X = \bar{U} \cup \bar{V}$ is a simple closed curve.

At least one of the two continuum U and V is an arc with endpoints x, y . If not, we can find $z \in \bar{U} - \{x, y\}$ and $t \in \bar{V} - \{x, y\}$ which are non-cut points of \bar{U} and \bar{V} respectively. Hence

$$X - \{z, t\} = (\bar{U} - \{z\}) \cup (\bar{V} - \{t\})$$

is connected which is a contradiction.

In fact both of them are arcs with endpoints x, y . If not, suppose for example that \bar{U} is not an arc. Then we can find $z \in U$ so that $\bar{U} - \{z\}$ is connected. Hence, since \bar{V} is an arc, we can find $t \in V$ such that $\bar{V} - \{t\} = R \cup S$ where R and S are two connected sets with $x \in R$ and $y \in S$. Therefore

$$X - \{z, t\} = (\bar{U} - \{z\}) \cup R \cup S$$

is connected, contrary to the assumption. \square

Theorem 3.6 (Converse of Jordan's Curve Theorem). *Let X be a plane continuum which has two distinct complementary domains R_0, R_1 from which it is at every point accessible. Then X is a simple closed curve.*

Proof. In view of what we have just shown, it is enough to prove that the connection of X is destroyed by the removal of two arbitrary points. Let x and y be two distinct points of X . Since both x and y are accessible from R_0 and R_1 , it is possible to find a cross-cut α_i with endpoints x, y in R_i for $i = 0, 1$. Hence $J = \alpha_0 \cup \alpha_1$ is a simple closed curve. But $\text{int}(J)$, like $\text{ext}(J)$, meets R_0 and R_1 and thus also $X = \text{Fr}(R_0) = \text{Fr}(R_1)$. Therefore

$$X - \{x, y\} = (\text{int}(J) \cap X) \cup (\text{ext}(J) \cap X)$$

is not connected. \square

Let X be a metric space. We recall that X is locally connected at a point $x \in X$ if there exist arbitrary small connected neighborhoods of x in X . We leave as an exercise the proof of the following.

Lemma 3.7. *The following conditions are equivalent.*

1. X is locally connected at every point $x \in X$,
2. Every point of X possesses arbitrary small open connected neighborhoods,
3. Every connected component of an open subset of X is itself open in X .

A space is arcwise connected if any two given points can be joined by an arc.

Theorem 3.8. *In a compact and locally connected space X , each connected open set is arcwise connected.*

In other words, two points of a connected open set can be joined by an arc lying entirely in U . The desired arc will be obtained as an intersection of a sequence $K_1 \supset K_2 \supset \dots$ of “thinner and thinner” sub-continua of U . To do this carefully, let us first define an auxiliary notion.

A *simple chain* is a finite sequence $\mathcal{C} = (C_1, \dots, C_n)$ of nonempty sets such that every two adjacent terms of the sequence intersect but no two non-adjacent terms do so. The sets C_1, \dots, C_n are called the *links* of \mathcal{C} , and if $a \in C_1$ and $b \in C_n$, then \mathcal{C} is said to be a *chain from a to b* .

If \mathcal{D}_1 and \mathcal{D}_2 are simple chains such that the concatenation of the sequence \mathcal{D}_1 followed by the sequence \mathcal{D}_2 is a simple chain \mathcal{D} , we will write $\mathcal{D} = \mathcal{D}_1 + \mathcal{D}_2$. Note that if $\mathcal{D} = \mathcal{D}_1 + \dots + \mathcal{D}_k$, then for $i < j$ each link of \mathcal{D}_i precedes each link of \mathcal{D}_j in \mathcal{D} .

Proof of theorem 3.8. Let U be a nonempty connected open subset of X and $a, b \in U$, $a \neq b$. It is easy to obtain a sequence $\mathcal{C}_1, \mathcal{C}_2, \dots$ of simple chains from a to b , $\mathcal{C}_n = (C_n^1, \dots, C_n^{k_n})$, such that for each n :

1. every link of \mathcal{C}_n is a connected open subset of U of diameter less than $1/n$,
2. the closure of each link of \mathcal{C}_{n+1} is a subset of some link of \mathcal{C}_n ,
3. there exists chains $\mathcal{D}_1^n, \dots, \mathcal{D}_{k_n}^n$ such that $\mathcal{C}_n = \mathcal{D}_1^n + \dots + \mathcal{D}_{k_n}^n$ and such that each link of \mathcal{D}_i^n is a subset of C_i^n for $i = 1, \dots, k_n$.

For each n , let K_n denote the union of the closures of all the links of \mathcal{C}_n and let

$$K = \bigcap_{n=1}^{\infty} K_n.$$

It is clear that K is a continuum lying in U and containing a and b . To prove that K is an arc it is sufficient to show that each point of $K - \{a, b\}$ is a cut point of K . To this end, suppose $p \in K - \{a, b\}$ and for each n let A_n (respectively B_n) be the set of all $x \in K$ such that every link of \mathcal{C}_n containing x precedes (follows) every link of \mathcal{C}_n containing p . Then

$$A = \bigcup_{n=1}^{\infty} A_n \quad \text{and} \quad B = \bigcup_{n=1}^{\infty} B_n$$

are two open sets of K such that $a \in A$, $b \in B$, $A \cap B = \emptyset$ (since $A_1 \subset A_2 \subset \dots$ and $B_1 \subset B_2 \subset \dots$) and $K - \{p\} = A \cup B$. \square

Lemma 3.9. *Any continuous image of a compact locally connected space is compact and locally connected.*

Proof. let U be an open set of $Y = f(X)$ and C be a connected component of U . We have to show that C is itself open in Y . Let (N_α) be those components of $f^{-1}(U)$ which meets $f^{-1}(C)$. Then $f^{-1}(C) = \bigcup_\alpha N_\alpha$, is an open set of X and hence $f(X) - C = f(X - f^{-1}(C))$ is closed in $Y = f(X)$. \square

An immediate corollary of these results is the following:

Corollary 3.10. *In a metric space, each path joining two distinct points a, b contains an arc with endpoints a, b .*

Theorem 3.11. *Every nonempty compact metric space is a continuous image of the Cantor set.*

Proof. Let X be a nonempty compact metric space. Choose a covering of X by compact subsets (not necessarily distinct) $A_1^1, \dots, A_{2^{p_1}}^1$ of diameter less than 1. Let $I_1^1, \dots, I_{2^{p_1}}^1$ be all the subintervals of the subdivision of $[0, 1]$ of length 3^{-p_1} which meet the middle-third Cantor set K and let $D_i^1 = K \cap I_i^1$ for $i = 1, \dots, 2^{p_1}$. We define then a map

$$F_1 : K \rightarrow 2^X$$

where 2^X is the set of all nonempty closed subset of X , by $F_1(t) = A_i^1$ if $t \in D_i^1$. Since each set D_i^1 is open (in K), the map F_1 is continuous (for the Hausdorff metric on 2^X).

Next, we cover each compact set A_i^1 by 2^{p_2} (not necessarily distinct) compact subsets of A_i^1 of diameter less than $1/2$ and let $F_2(t) = A_j^2$ if $t \in D_j^2 = K \cap I_j^2$ where $I_1^2, \dots, I_{2^{p_1+p_2}}^2$ are the subinterval of the subdivision of $[0, 1]$ of length $3^{-p_1+p_2}$ which meets K .

Inductively, we construct, this way, a sequence (F_n) of maps such that for each n ,

1. $F_n : K \rightarrow 2^X$ is continuous,
2. $F_n(t) \supset F_{n+1}(t)$ for all $t \in K$,
3. $X = \bigcup_{t \in K} F_n(t)$,
4. the diameter of $F_n(t)$ is less than $1/n$.

For all $t \in K$ let $f(t)$ be the unique point of $\bigcap_{n=1}^\infty F_n(t)$. It is then straightforward to check that f is continuous. \square

Theorem 3.12 (Hahn-Mazurkiewicz). *A continuum is locally connected if and only if it is the continuous image of the unit interval.*

Proof. That a continuous image of the unit interval is a locally continuum follows from lemma 3.9. To prove the converse, we chose first a continuous map $f : K \rightarrow X$ from the Cantor set onto our locally connected continuum X . It is easy to check that a locally connected continuum is in fact uniformly locally connected. Using the uniform continuity of f and theorem 3.8, it is then straightforward to show that f can be extended continuously on each of the subinterval $]a_i, b_i[$ of $[0, 1] - K$. \square

Exercises

Exercise 3.1. Let (X_n) a nested sequence of continuum, show that

$$\bigcap_{n=1}^{+\infty} X_n$$

is a continuum.

Exercise 3.2. Show that the boundary of a simply connected and uniformly locally connected plane bounded domain is a simple closed curve (Second Form of the Converse of Jordan's Curve Theorem).

Exercise 3.3. Let X be a compact metric space and 2^X be the set of all nonempty closed subset of X . For $A, B \in 2^X$, we let

$$d_H(A, B) = \max \left\{ \sup_{a \in A} d(a, B), \sup_{b \in B} d(b, A) \right\}.$$

Show that $(2^X, d_H)$ is a compact metric space and that the subset $C(X)$ of all sub-continua of X is closed in this topology. [Hint: Show that 2^X is complete and totally bounded (for any $\varepsilon > 0$, 2^X can be written as a finite union of sets of diameter less than ε).]

Exercise 3.4. Show that theorem 3.8 is still true if X is only supposed to be locally compact or complete.

Exercise 3.5. Using the proof of theorem 3.11, show that a compact, metric, perfect and totally disconnected set is homeomorphic with the Cantor set.

Chapter 4

Indecomposable Continua

Definition 4.1. A continuum X is *decomposable* provided that X can be written as the union of two proper sub-continua. A continuum which is not decomposable is said to be *indecomposable*.

We have the following:

Lemma 4.2. A continuum X is indecomposable if and only if each of its sub-continua has empty interior.

Proof. The proof is straightforward, and will be left to the reader. \square

Let $a, b \in X$ two distinct points of a continuum. We say that X is *irreducible* between a and b if there exists no proper sub-continuum of X which contains both a and b . There is a surprisingly simple argument to check that a continuum is indecomposable.

Lemma 4.3. If there exist three points in a continuum X such that X is irreducible between each two of these three points then X is indecomposable.

Again the proof is straightforward and will be omitted. We will see later that this condition is also necessary if X is nondegenerate (lemma 4.11).

Remark 4.4. An indecomposable continuum is clearly nowhere locally connected. Moreover, if C is any proper sub-continuum of X , then $X - C$ is connected. In particular, an indecomposable continuum has no cut-point.

Example 4.5. Let a, b and c be distinct points in the plane. It is easy to construct simple chains $\mathcal{C}^n = (C_1, \dots, C_{k_n})$, $n = 1, 2, \dots$ whose links are discs of diameter $< 2^{-n}$ satisfying conditions below:

1. For each $n = 1, 2, \dots$ the closure of each link of \mathcal{C}^{n+1} is a subset of a link of \mathcal{C}^n ,
2. For each $n = 1, 2, \dots$, \mathcal{C}^{3n+1} goes from a to c through b , \mathcal{C}^{3n+2} goes from b to c through a , \mathcal{C}^{3n+3} goes from a to b through c .

We set

$$K_n = \bigcup_{i=1}^{k_n} \bar{C}_i^n \quad \text{and} \quad K = \bigcap_{n=1}^{\infty} K_n$$

It is then easy to check that K is irreducible between each two of the three points a, b and c (See Figure 4.1).

Surprisingly, “almost” every continuum is indecomposable.

Lemma 4.6. In the space $C(D^2)$ of sub-continua of a the unit disc D^2 (with the Hausdorff metric), the set of nondegenerate indecomposable sub-continua is a dense countable intersection of open sets (dense G_δ).

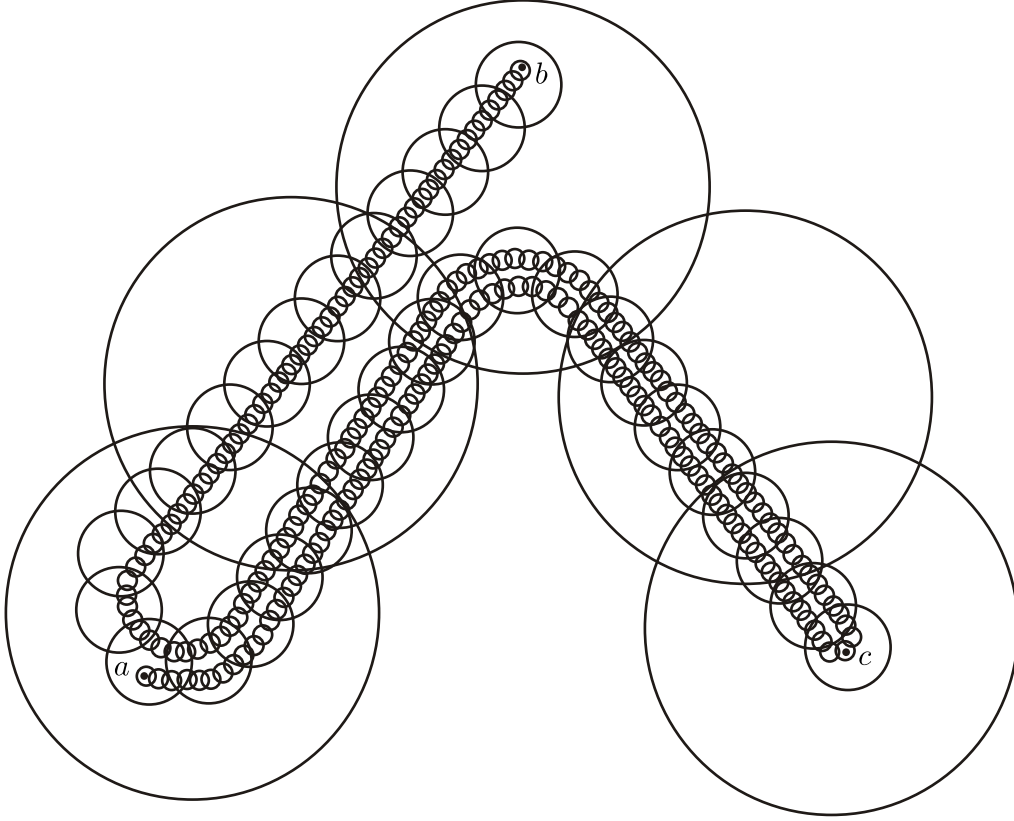

Figure 4.1: An indecomposable continuum

Proof. Let \mathcal{I} be the set of non degenerate indecomposable continua of D^2 and F_n be the set of all the sub-continua which are the union of two sub-continua A and B such that $A \not\subset V(B, 1/n)$ and $B \not\subset V(A, 1/n)$. F_n is a closed subset of $C(D^2)$, the set of all sub-continua of D^2 . Hence, the complement of \mathcal{I} (in $C(D^2)$) can be written as $\bigcup_{n=1}^{\infty} F_n$.

Furthermore, \mathcal{I} is a dense set in $C(D^2)$. Indeed, let $C \in C(D^2)$ and $\varepsilon > 0$. It is easy to construct a polygonal arc α in D^2 with $d_H(\alpha, C) < \varepsilon/2$ (where d_H is the Hausdorff metric). Using the construction of Example 1, it is then possible to construct an indecomposable continuum K such that $d_H(K, C) < \varepsilon$. \square

Example 4.7 (The Pseudo-arc). Let \mathcal{C} and \mathcal{D} be two simple chains where \mathcal{C} *strongly refines* \mathcal{D} (meaning the closure of each link of $\mathcal{C} = (C_1, \dots, C_n)$ is contained in a link of $\mathcal{D} = (D_1, \dots, D_m)$). We say that \mathcal{C} is *crooked* in \mathcal{D} provided that if $k - h > 2$ and C_i and C_j are links in D_h and D_k of \mathcal{D} , respectively, then there are links C_r and C_s of \mathcal{C} in links D_{k-1} and D_{h+1} respectively, such that either $i > r > s > j$ or $i < r < s < j$.

In the plane, let $\mathcal{C}^1, \mathcal{C}^2, \dots$ be a sequence of chains between two distinct points a and b such that for each $n = 1, 2, \dots$ we have

1. \mathcal{C}^{n+1} is crooked in \mathcal{C}^n ,
2. the diameter of each link of \mathcal{C}^n is less than $1/n$.

Set

$$K_n = \bigcup_{i=1}^{k_n} \mathcal{C}_i^n.$$

Then $K = \bigcap_{n=1}^{\infty} K_n$ is called a pseudo-arc. It is an indecomposable continuum. It has the amazing following property. If H is a nondegenerate sub-continuum of K , then H is indecomposable. That is the pseudo-arc is *hereditarily indecomposable*.

In particular K contained no arc. Moise [14] proved that every two pseudo-arcs are homeomorphic and Bing [5] gave a topological characterization of *the* Pseudo-arc.

Let X a continuum and $x \in X$. The *composant* of x is the union of all proper sub-continua of X which contain x . It is also the set of all points y such that X is not irreducible between x and y .

Two composants are not necessarily disjoint. For example an arc ab has exactly three composants, namely, ab , $ab - \{a\}$ and $ab - \{b\}$ corresponding to $x \neq a, b$, or $x = a$, or $x = b$. In fact it is easy to show that every decomposable continuum is a composant for some point.

In a space which is not connected the composants are the same as the components and this notion has no interest, but this notion is very useful in the study of indecomposable continua as we will see later.

Lemma 4.8. *In a nondegenerate continuum X , each composant is a dense union of a countable family of proper subcontinua.*

Proof. Let C be a composant defined by a point p and U, V be nonempty open sets in X with $\bar{V} \subset U$. If $p \notin \bar{V}$, the closure of the component N of $X - \bar{V}$ which contains p is contained in C . But $\bar{N} \cap Fr(V) \neq \emptyset$ (see Exercise 4.4), so that $C \cap U \neq \emptyset$. Hence $\bar{C} = X$.

To prove that C is a countable union of proper sub-continua of X , choose a countable basis U_1, U_2, \dots for $X - \{p\}$ and let N_i be the component of p in $X - \bar{U}_i$ then $C = \bigcup_i \bar{N}_i$. \square

Corollary 4.9. *Every composant of an indecomposable continuum has empty interior.*

The proof is a straightforward application of Baire's theorem. In fact it is easy to verify, the following.

Lemma 4.10. *If a continuum has a composant with empty interior then it is decomposable.*

Lemma 4.11. *If X is an indecomposable continuum, the composants of X partition X and there are uncountably many of them.*

Proof. Let C_1 and C_2 be two composants defined respectively by the points p_1 and p_2 and suppose that there exists $x \in C_1 \cap C_2$. Then we can find

- a proper sub-continuum $K_1 \subset C_1$ such that $x, p_1 \in K_1$,
- a proper sub-continuum $K_2 \subset C_2$ such that $x, p_2 \in K_2$.

Thus $K = K_1 \cup K_2$ is a proper sub-continuum of X . Let y be any point of C_1 . There exists a proper sub-continuum $K_3 \subset C_1$ such that $y, p_1 \in K_3$, thus $K' = K \cup K_3$ is a proper sub-continuum of X and therefore $y \in C_2$. Hence, $C_1 \subset C_2$ and similarly $C_2 \subset C_1$.

Suppose there are at most a countable many distinct composants. Then $X = \bigcup_n C_n$ is also an at most countable union of proper sub-continua, each of which having empty interior. But this is not possible by Baire's theorem. \square

Example 4.12 (Knaster's Continuum). We begin with the Cantor middle-third set C . Then we add to C all the semicircles lying in the upper half plane with center at $(1/2, 0)$ that connect each pair of points in the Cantor set that are equidistant from $1/2$. Next we add all semicircles in the lower half plane which have for each $n \geq 1$ centers at $(5/(2 \cdot 3^n), 0)$ and pass through each point in the Cantor set lying in the interval

$$2/3^n \leq x \leq 1/3^{n-1}$$

The resulting set is partially depicted in [Figure 4.2](#). The fact that this set is indecomposable results from the following observation [11]. The component of the origin is the curve obtained by starting from the origin and then following successively all the successive semicircles. This curve has empty interior.

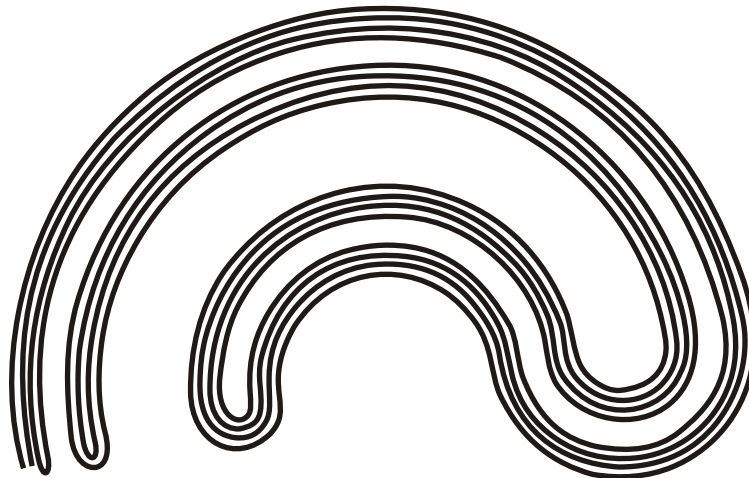

Figure 4.2: Knaster's Continuum

We are now going to describe another way to look at continua, namely via inverse limits. This gives in some case, a parametrization of a continuum by a simpler space.

Let (X, d) be a metric space and $f : X \rightarrow X$ a continuous map, the *inverse limit space*, (X, f) is the space

$$(X, f) = \{x = (x_0, x_1, \dots); x_n \in X \text{ and } f(x_{n+1}) = x_n \text{ for all } n \geq 0\}$$

with metric d given by

$$d(x, y) = \sum_{n=0}^{\infty} \frac{d(x_n, y_n)}{2^n}.$$

If X is a continuum, then (X, f) is also a continuum. The map f induces a homeomorphism

$$\hat{f} : (X, f) \rightarrow (X, f)$$

given by

$$\hat{f}((x_0, x_1, \dots)) = (f(x_0), x_0, \dots)$$

from which the inverse is just the usual shift map.

Lemma 4.13. *Let X be a continuum and $f : X \rightarrow X$ be a surjective continuous map such that whenever $X = A \cup B$ where A and B are sub-continua of X , we have $f(A) = X$ or $f(B) = X$. Then, (X, f) is an indecomposable continuum.*

Proof. Let $X_{\infty} = (X, f)$ and suppose there exist two sub-continua A_{∞} and B_{∞} of X_{∞} with $X_{\infty} = A_{\infty} \cup B_{\infty}$. Let $\pi_n : X_{\infty} \rightarrow X$ be the natural projection onto the n th coordinate. From the relation $\pi_n(X_{\infty}) = \pi_n(A_{\infty}) \cup \pi_n(B_{\infty}) = X$ for all $n \geq 0$, and from the property of f , it follows that there are infinite many n for which we have, say $\pi_n(A_{\infty}) = X$. It follows then from the relation $f_n \circ \pi_{n+1} = \pi_n$ which is true on X_{∞} , that $\pi_n(A_{\infty}) = X$ for all $n \geq 0$. Hence A_{∞} is dense in X_{∞} and thus $A_{\infty} = X_{\infty}$. \square

Remark 4.14. The preceding lemma is still true if we replace the hypothesis of the lemma by the weaker one : there exists $N > 0$ such that for all sub-continua A, B of X such that $X = A \cup B$, then $f^N(A) = X$ or $f^N(B) = X$.

Example 4.15 (The Solenoid). Let $X = S^1$, the unit circle and $f : S^1 \rightarrow S^1$ the map given by $f(\theta) = p\theta$ ($p \geq 2$). Then (X, f) is an indecomposable continua which is called the p-adic solenoid Σ_p . There is a natural group structure on Σ_p inherited from the one on S^1 . We can deduce from this fact that Σ_p is *homogenous* (meaning that from any two points there is a homeomorphism of Σ_p onto Σ_p taking one of these point to the other). We can show also that each proper sub-continuum of Σ_p is an arc. It is interesting to note that the last two properties actually characterize solenoid [8].

A continuum Λ which separates the plane into exactly two components and which is irreducible with respect to this property will be called a *cofrontier*. Let U_i be the bounded complementary domain of Λ and U_e be the unbounded one. Then $Fr(U_i)$ and $Fr(U_e)$ are subcontinua of Λ which separate the plane thus, $Fr(U_i) = Fr(U_e) = \Lambda$. Conversely, if a plane continuum Λ separates the plane into exactly two complementary domains and is there common frontier, then Λ irreducibly separates the plane and is therefore a cofrontier.

Remark 4.16. Indecomposable continuum have been discovered by Brouwer to show that Schoenflies' conjecture that every cofrontier could be decomposed into the union of two proper subcontinua was wrong.

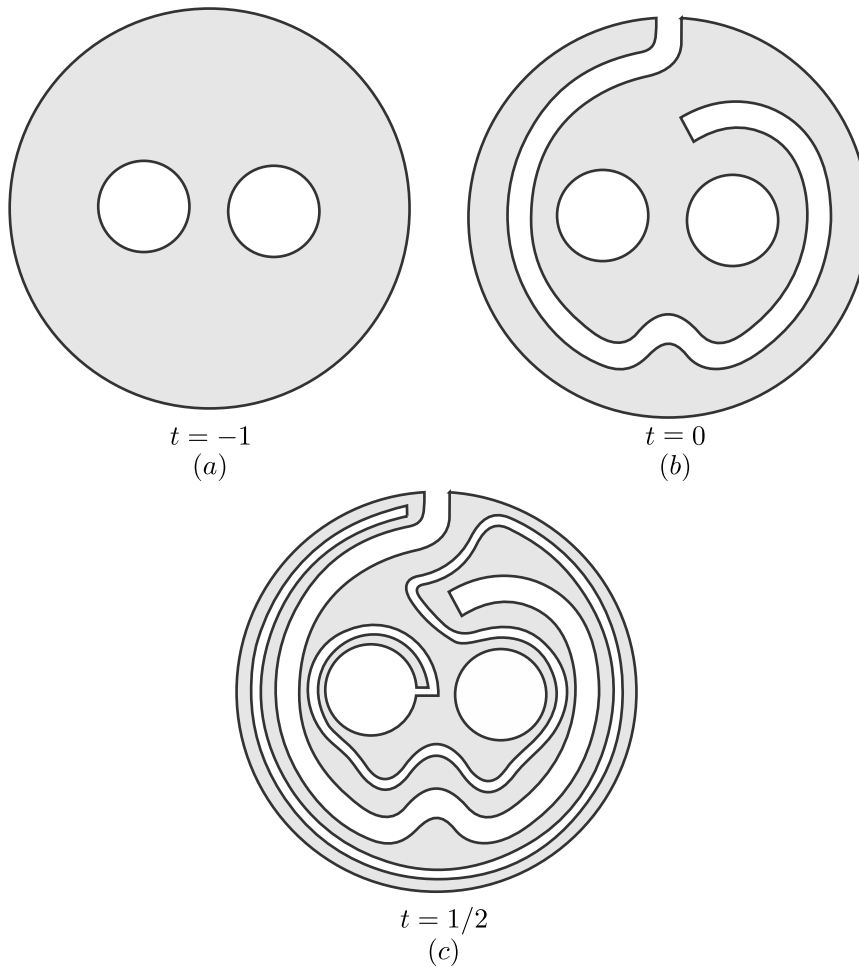

Figure 4.3: Wada Lakes

Note that a continuum which is the common boundary of two simply connected domains is not necessary a cofrontier as we will see below. The first explicit example of a such continuum was reported in a paper by Yoneyama in 1917 [23]. This beautiful example is known as the Lakes of Wada continuum. In his paper Yoneyama states that the example was reported to him

by a Mr. Wada, but no one seems to know anything else about Mr. Wada. In 1924, Kuratowski [11] proved that if K is a plane continuum is the common boundary of more than 3 disjoint open sets then K is either indecomposable or the union of two indecomposable continua.

To preserve the poetic flavour of the original example [9], we take a double annulus, as shown in Figure 4.3, to be a island in the ocean with two lakes, one having blue water and the other red water. At time $t = 0$, we dig a canal from the ocean, which brings salt water to within a distance of 1 unit of every point of land. At time $t = 1/2$, we dig a canal from the blue lake, which bring blue water to within a distance $1/2$ of every point of land. At time $3/4$, we dig a canal to bring red water to within a distance of $1/3$ at every point of land. At time $t = 7/8$, we dig a canal from the end of the first canal to bring salt water to within a distance $1/4$ of every point of land and so forth. If we think of these canals as open sets, at time $t = 1$, the “land” remaining is a plane continuum which bounds *three* open domains in the plane.

Exercises

Exercise 4.1. In Theorem 4.5, give a meaning to the statement “the simple chains are as straight as possible in each other” (see the construction of the arc in the proof of theorem 3.8). Obtain, this way, an indecomposable continuum such that every of its proper nondegenerate sub-continua is an arc.

Exercise 4.2. Show that Theorem 4.7 (the Pseudo-arc) is hereditarily indecomposable.

Exercise 4.3. Show that most of the sub-continua of a closed 2-cell are hereditarily indecomposable.

Exercise 4.4. Let X be a continuum, U an open set of X and N a component of U . Then, $\bar{N} \cap Fr(U) \neq \emptyset$.

Exercise 4.5. Suppose Λ is a locally connected cofrontier, then Λ is a simple closed curve.

Chapter 5

Attractors and Indecomposable Continua

Let X be a compact metric space and $f : X \rightarrow X$ a continuous map. A nonempty compact subset $\Lambda \subset X$ is an *attractor* for f if there is an open neighbourhood U of Λ such that $f(\bar{U}) \subset U$ and

$$\Lambda = \bigcup_{n \geq 0} f^n(\bar{U}).$$

An attractor is clearly an invariant set for f ($f(\Lambda) = \Lambda$). There are other definitions of attractors in common use, but this one is perhaps the simplest. However this definition suffers the defect that it does not produce a single, indecomposable attractor. To remedy this, we introduce the following terminology: Λ is a *transitive attractor* for f if f is *topologically transitive* on Λ , that is for any pair of open sets $U, V \subset X$ there exist $k > 0$ such that $f^k(U) \cap V \neq \emptyset$.

Given a point p , the *stable set* of p is given by

$$W^s(p) = \{z \in X; d(f^n(p), f^n(z)) \rightarrow 0 \text{ as } n \rightarrow +\infty\}.$$

Equivalently, a point z lies in $W^s(p)$ if p and z are forward asymptotic. Similarly, we define the *unstable set* of p to be

$$W^u(p) = \{z \in X; d(f^{-n}(p), f^{-n}(z)) \rightarrow 0 \text{ as } n \rightarrow +\infty\}.$$

We say that a periodic point of f (ie a point p for which there exists $n > 0$ with $f^n(p) = p$) is stable (resp unstable) if $W^s(p)$ (resp $W^u(p)$) is a neighbourhood of p . See [7], for a beautiful introduction to Dynamical Systems

Example 5.1 (The Horseshoe Map). Let S be the square $I \times I$ where $I = [0, 1]$, and let D be the two dimensional disc $D = S \cup A \cup B$ where A and B are half disc attached to opposite sides $\{0\} \times I$ and $\{1\} \times I$ of the square S as depicted in [Figure 5.1](#).

The standard horseshoe map F takes D inside itself according to the following prescription. First, linearly contract S in the vertical direction by a factor $\delta < 1/2$ and expand it in the horizontal direction by a factor $1/\delta$ so that S is long and thin. Then put S back inside D in a horseshoe shaped figure as in [Figure 5.2](#). The semicircular regions A and B are contracted and mapped inside A as depicted. We remark that $F(D) \subset D$ and that F is one-to-one. However, since F is not onto, F^{-1} is not globally defined.

Now let $\pi : D \rightarrow I$ given by $\pi(A) = \{0\}$, $\pi(B) = \{1\}$ and $\pi((x, y)) = x$ for all $(x, y) \in S = I \times I$. The map F has the following properties:

1. $F(\pi^{-1}(\pi(z))) \subset \pi^{-1}(\pi(F(z)))$ for all $z \in D$,
2. $F(A) \subset \text{int}(A)$ and $F(B) \subset \text{int}(A)$,

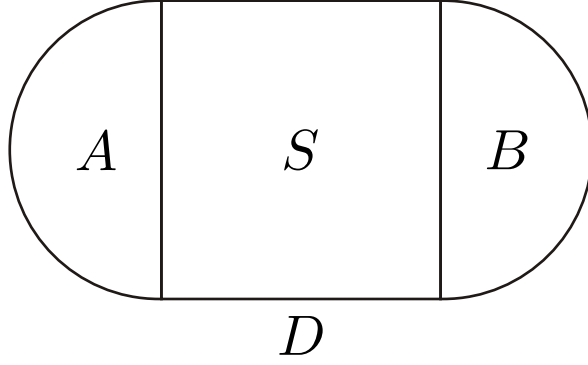

Figure 5.1: Building the Horseshoe

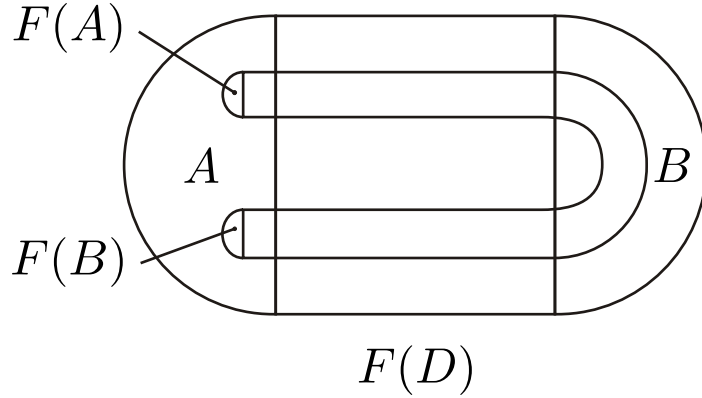

Figure 5.2: The Horseshoe

3. For all $x \in I$, $\pi^{-1}(x) \cap F(D)$ has exactly two components,
4. $\text{diam}(F^n(\pi^{-1}(\pi(z)))) \rightarrow 0$ uniformly in $z \in D$ as $n \rightarrow +\infty$.

The attractor for the horseshoe map F is the set

$$\Lambda_H = \bigcap_{n \geq 0} F^n(D).$$

It is possible to show that Λ_H is homeomorphic to Knaster's continuum ([Theorem 4.12](#)). However, we are going to show the indecomposability of Λ_H by other means.

F induces a continuous map of the interval $f : I \rightarrow I$ defined by $f(x) = \pi(F(\pi^{-1}(z)))$. The map f has the following properties $f(0) = f(1) = 0$ and there exist $0 < a_1 < a_2 < a_3 < a_4 < 1$ such that f is strictly increasing on $[a_1, a_2]$, f is strictly decreasing on $[a_3, a_4]$, $f([0, a_1]) = f([a_4, 1]) = \{0\}$ and $f([a_2, a_3]) = \{1\}$ (see [Figure 5.3](#)).

Theorem 5.2. Let $\hat{\pi} : \Lambda_H \rightarrow (I, f)$ defined by

$$\hat{\pi}(z) = (\pi(z), \pi(F^{-1}(z)), \dots).$$

Then $\hat{\pi}$ is a homeomorphism such that $F \circ \hat{\pi} = \hat{f} \circ \hat{\pi}$. That is, $F|_{\Lambda_H}$ and \hat{f} are topologically conjugate.

Proof. The following proof is due to Barge [\[3\]](#). Since

$$f(\pi(F^{-(n+1)}(z))) = \pi(F(F^{-(n+1)}(z))) = \pi(F^{-n}(z)),$$

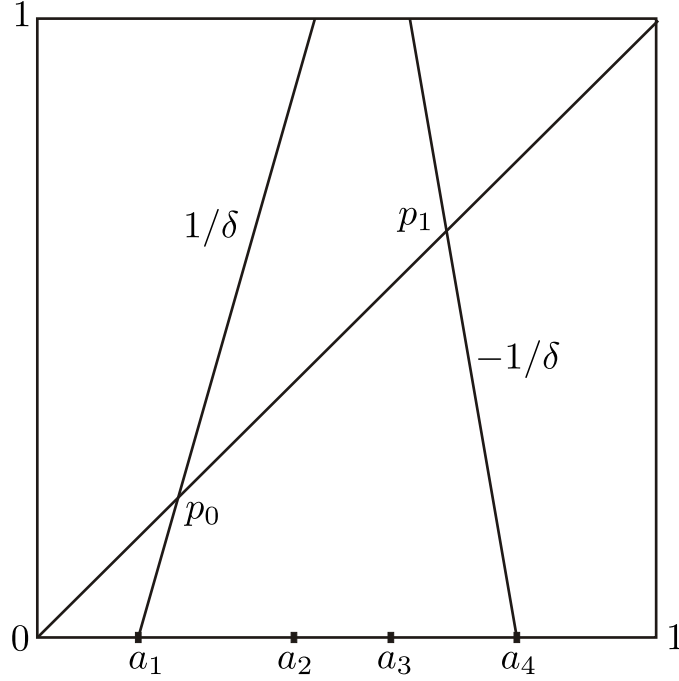

Figure 5.3:

we see that $\hat{\pi}(z)$ is indeed an element of (I, f) .

$\hat{\pi}$ is clearly continuous. To see that $\hat{\pi}$ is one-to-one and onto, let $\mathbf{x} = (x_0, x_1, \dots) \in (X, f)$ and let

$$C_n = F^n(\pi^{-1}(x_n)) \quad \text{for } n = 0, 1, \dots$$

Then C_n is a closed, nonempty subset of D for each $n \geq 0$, and since

$$F(\pi^{-1}(x_{n+1})) \subset \pi^{-1}(f(x_{n+1})) = \pi^{-1}(x_n),$$

we have $C_{n+1} \subset C_n$ for all $n \geq 0$. Thus $\bigcap_{n \geq 0} C_n$ is a nonempty compact set. But since $\text{diam}(C_n) \rightarrow 0$ as $n \rightarrow +\infty$ (condition (4)), we have $\bigcap_{n \geq 0} C_n = \{z\}$ is a singleton. Now if $z \in \bigcap_{n \geq 0} C_n$, then

$$\pi(z) = x_0, \quad \pi(F^{-1}(z)) = x_1, \quad \dots$$

That is, $\hat{\pi}(z) = \mathbf{x}$, but then z must be in $\bigcap_{n \geq 0} C_n$. $\hat{\pi}$ is one to one as well as onto. \square

It follows then from Lemma 4.13 that Λ_H is an indecomposable continuum. We note also, that f has two unstable fixed point p_0 and p_1 and one stable fixed point 0. These points correspond to fixed points for \hat{f} , $\mathbf{p}_0 = (p_0, p_0, \dots)$ and $\mathbf{p}_1 = (p_1, p_1, \dots)$ and thus to fixed points for F in S . Given an arbitrary point $x \in I$, there exists a unique $x_1 \in [a_1, a_2]$ such that $f(x_1) = x$, then a unique $x_2 \in [a_1, a_2]$ such that $f(x_2) = x_1$ and so on. In this way, we construct a sequence $\mathbf{x} = (x, x_1, x_2, \dots) \in (X, f)$ with the property that $\hat{f}^{-n}(\mathbf{x}) \rightarrow 0$ as $n \rightarrow +\infty$. Moreover, since $\hat{f}(W^u(\mathbf{p}_0)) \subset W^u(\mathbf{p}_0)$, this shows that $W^u(\mathbf{p}_0)$ is dense in Λ_H .

Example 5.3 (The Solenoid from dynamical viewpoint). Let $T = S^1 \times D^2$ be a solid torus in \mathbb{R}^3 and consider the map

$$F(\theta, x) = (2\theta, \frac{1}{10}x + \frac{1}{2}e^{2\pi i\theta})$$

where $x \in D^2$ and $\theta \in S^1$. Globally, F may be interpreted as follows. In the θ coordinate, F is simply the doubling map $\theta \mapsto 2\theta$. In the D^2 -direction, F is a strong contraction, with image a disc whose center depends on θ . Thus the image of T is another solid torus inside T which wraps twice around T (see Figure 5.4).

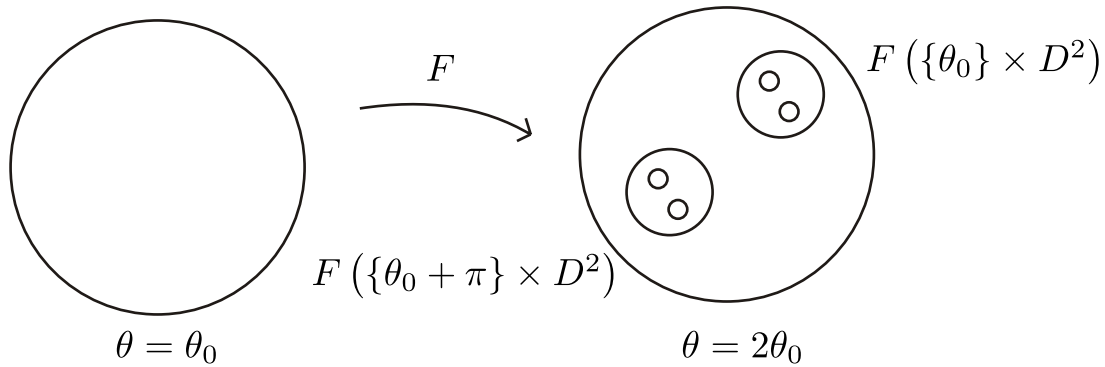

Figure 5.4: the Solenoid

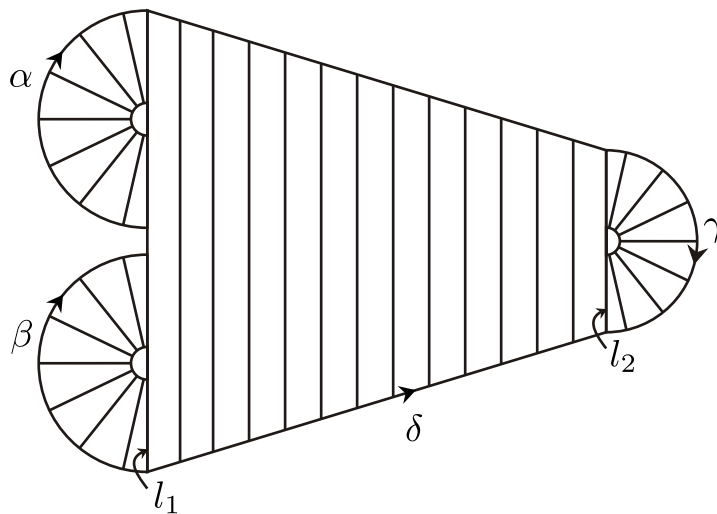

Figure 5.5: the Plykin attractor

We set $\Lambda_S = \bigcup_{n \geq 0} F^n(T)$. Let $\pi : S^1 \times D^2 \rightarrow S^1$ be the projection onto the first factor. We can show as in the case of the horseshoe map that the induced map $\hat{\pi} : \Lambda_S \rightarrow (S^1, g)$ given by

$$\hat{\pi}(z) = (\pi(z), \pi(F^{-1}(z)), \dots).$$

where $g : \theta \mapsto 2\theta$ gives a conjugacy between F on Λ_S and \hat{g} on (S^1, g) . This construction gives us also a way to embed the solenoid Σ_2 defined in [Theorem 4.12](#) into the 3-space R^3 .

In fact, the inverse limit construction works well for a class of attractors known as “expanding” attractors. These attractors are characterized by uniform expansion within the attractor itself. As in the case of the solenoid, such attractors can be suitably modeled by an inverse limit of a lower dimensional expanding map like $\theta \mapsto 2\theta$ on S^1 .

The main difference is that the model space is more complicated than S^1 ; usually it is a “branched one-manifold”, a continuum which is the union of a finite number of arcs each of which intersecting by pairs only in their endpoints. This concept was introduced by Williams [22]. He showed that every hyperbolic, one-dimensional, expanding attractor for a discrete dynamical system is topologically conjugate to the induced map on an inverse limit space based on a branched one-manifold. We will illustrate it via an example of an attractor due to Plykin. Rather than give a formula for this map, we will define it geometrically, as we did it for the horseshoe.

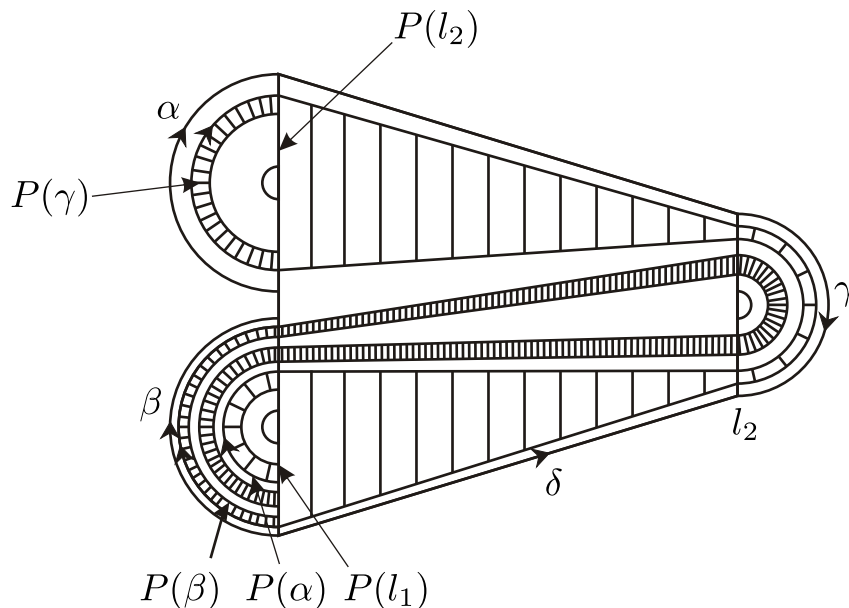

Figure 5.6: the Plykin attractor mapped to itself

Example 5.4 (Plykin attractor). Consider the region R in the plane depicted in Figure 5.5. R is a region with three open half disc removed. We equip R with a foliation whose leaves are intervals as shown in Figure 5.5.

Define a map $P : R \rightarrow R$ as shown in Figure 5.6. We require that P preserves and contracts the leaves of the foliation. Note that $P(R)$ is contained in the interior of R , so that $\Lambda_P = \bigcap_{\gamma \geq 0} P^\gamma(R)$ is an attractor; the Plykin attractor.

Since the leaves are contracted, any two points on the same leaf tend to the attractor in the same asymptotic manner. Thus to understand the action of P globally, it suffices to understand the action of P on the leaves. We thus collapse each leaf to a point as in Figure 5.7, and examine the induced map on this space.

Observe that the collapsed space Γ has "branched" points along the singular leaves l_1 and l_2 . As in the example of the horseshoe map, we introduce a projection $\pi : R \rightarrow \Gamma$ where $\Gamma = \alpha \cup \beta \cup \gamma \cup \delta$. Since P preserves the foliation, P induces a continuous map $g : \Gamma \rightarrow \Gamma$ which preserves the two vertices and maps the other intervals this way:

$$\alpha \rightarrow \beta, \quad \beta \rightarrow \beta + \gamma - \delta - \beta, \quad \gamma \rightarrow \alpha, \quad \delta \rightarrow \delta - \gamma - \delta,$$

where the signs indicate orientations in which the image crosses the given arc. We may construct such a map so that g expands all distances in the branched one-manifold Γ . Using lemma 4.13, we see then that (Γ, g) is an indecomposable continuum and as before it can be shown that the restriction of P to Λ_P is topologically conjugate to the induced map \hat{g} on (Γ, g) . However there exist more complicated situations as will be shown below.

A fixed point p for a C^1 -diffeomorphism $F : \mathbb{R}^n \rightarrow \mathbb{R}^n$ is called hyperbolic if $f'(p)$ has no eigenvalues on the unit circle. We note $E^s(p)$ (resp. $E^u(p)$) the sum of the characteristic spaces corresponding to eigenvalues of modulus less (resp. greater) than 1. We have then the two following fundamental results [17].

Theorem 5.5 (Grobman-Hartman Theorem). *Let $F : \mathbb{R}^n \rightarrow \mathbb{R}^n$ be a C^1 -diffeomorphism with a hyperbolic fixed point p . Then there exists a homeomorphism h defined on some neighbourhood U of p such that $h \circ f = f^l(p) \circ h$.*

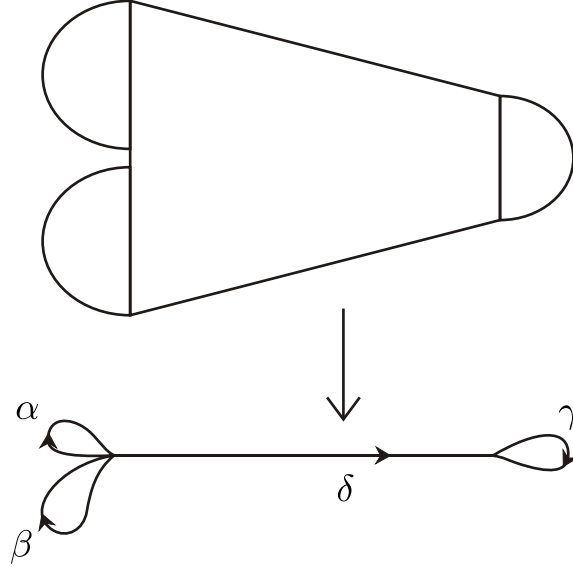

Figure 5.7:

Theorem 5.6 (Stable Manifold Theorem). *Let $F : \mathbb{R}^n \rightarrow \mathbb{R}^n$ be a C^1 -diffeomorphism with a hyperbolic fixed point p . Then there are local stable and unstable manifolds $W_{loc}^s(p)$ and $W_{loc}^u(p)$ tangent to the characteristic spaces E_p^s and E_p^u of $f'(p)$ at p and of corresponding dimensions.*

Global stable and unstable manifolds are defined by taking the union of backward and forward iterates of the local manifolds. We have

$$W_{loc}^s(p) = \{x \in U \mid F^n(x) \rightarrow p \text{ as } n \rightarrow +\infty, \text{ and } F^n(x) \in U, \forall n \geq 0\}$$

$$W_{loc}^u(p) = \{x \in U \mid F^{-n}(x) \rightarrow p \text{ as } n \rightarrow +\infty, \text{ and } F^n(x) \in U, \forall n \geq 0\}$$

and

$$W^s(p) = \bigcup_{n \geq 0} F^{-n}(W_{loc}^s(p))$$

$$W^u(p) = \bigcup_{n \geq 0} F^n(W_{loc}^u(p))$$

$W^s(p)$ and $W^u(p)$ are images of immersions from \mathbb{R}^{n_s} and \mathbb{R}^{n_u} but may not be submanifolds of \mathbb{R}^n . They may be rather complicated set as was shown by Barge [3] in the two following results.

Let $F : \mathbb{R}^2 \rightarrow \mathbb{R}^2$ be a C^1 -diffeomorphism and $p \in \mathbb{R}^2$ a hyperbolic fixed point for F with one dimensional stable and unstable manifolds $W^s(p)$ and $W^u(p)$. Let $W^{u+}(p)$ be one of the branches of $W^u(p)$ and assume that $F(W^{u+}(p)) = W^{u+}(p)$ (otherwise, replace F by F^2). We are going to show that under certain conditions the closure of $W^{u+}(p)$ is an indecomposable continuum, as it was the case of the unstable set of the fixed point \mathbf{p}_0 in the horseshoe map.

Let $B_1 = [-1, 1] \times [0, 1]$. By virtue of Grobman-Hartman theorem 5.5 there exists an embedding

$$\Psi : B_1 \rightarrow \mathbb{R}^2$$

such that $\Psi([-1, 1] \times \{0\}) = W_{loc}^s(p)$ and $\Psi(\{0\} \times [0, 1]) = W_{loc}^{u+}(p)$ and $A = \Psi^{-1} \circ F \circ \Psi$ is linear where defined.

We consider the following conditions on F :

(H_1) $\overline{W^{u+}(p)}$ is compact,

(H₂) There is an arc α in $\Psi(B_1) \cap W^{u+}(p)$ such that $\alpha \cap W_{loc}^s(p) \neq \emptyset$ and $\alpha \not\subset W_{loc}^s(p)$,

(H₃) There exist $-1 < a < 0 < b < 1$ such that $\Psi(a, 0), \Psi(b, 0) \notin \overline{W^{u+}(p)}$.

Remark 5.7. 1. Conditions (H₁) and (H₂) forbid the trivial situation where $W^s(p) \subset W^{u+}(p)$ and $\overline{W^{u+}(p)}$ is a simple closed curve.

2. The three conditions are satisfied when $\overline{W^{u+}(p)}$ is compact and $W^{u+}(p)$ contains a transverse homoclinic point.

Theorem 5.8 (Barge). *Suppose that $F : \mathbb{R}^2 \rightarrow \mathbb{R}^2$ be a C^1 -diffeomorphism with hyperbolic fixed point p as above that satisfies conditions (H₁), (H₂) and (H₃). Then $\overline{W^{u+}(p)}$ is an indecomposable continuum.*

Proof. Let $\phi : [0, +\infty[\rightarrow \mathbb{R}^2$ be a continuous one-to-one, onto parametrization of $W^{u+}(p)$.

(1) $\forall t \in \mathbb{F}$, we have

$$\overline{\phi([t, +\infty))} = \overline{W^{u+}(p)}$$

Indeed, let $\alpha = \phi([u, v])$ where $\phi(u) \in W^s(p)$ and $\alpha \not\subset W_{loc}^s(p)$ be as in (H₂). For $n \geq 0$, let α_n be the component of $F^n(\alpha) \cap \Psi(B_1)$ which contains $F^n(\phi(t))$. Hyperbolicity of F at p implies that $\limsup(\alpha_n) = W_{loc}^{u+}(p)$. But for all sufficiently large n , $\alpha_n \subset \phi([t, +\infty])$ so that

$$W_{loc}^{u+}(p) \subset \phi([t, +\infty))$$

and hence (1).

(2) Suppose now that $\overline{W^{u+}(p)}$ is decomposable. Then there exists a proper sub-continuum H of $\overline{W^{u+}(p)}$ with nonempty interior (relatively to $\overline{W^{u+}(p)}$). That is

- For all $t \geq 0$, $\text{int}(H) \cap \phi([t, +\infty]) \neq \emptyset$,
- For all $t \geq 0$, $\phi([t, +\infty]) \not\subset H$ (since H is proper).

Therefore we can find $0 \leq t_1 < t_2 < t_3 < t_4$ such that $\phi(t_1), \phi(t_3) \notin H$ but $\phi(t_2), \phi(t_4) \in H$. Let N be large enough so that

$$F^{-N}(\phi(t_i)) \in W_{loc}^{u+}(p)$$

for $i = 1, 2, 3, 4$ and let $0 \leq y_1 < y_2 < y_3 < y_4$ be such that $\Psi(0, y_i) = F^{-N}(\phi(t_i))$. Since $F^{-N}(H)$ is compact, it is possible to find $0 < r \leq 1$ such that

$$\Psi([-r, r] \times \{y_i\}) \cap F^{-N}(H) = \emptyset$$

for $i = 1$ and $i = 3$. Choose $\epsilon > 0$ such that if $L_a = \{a\} \times [0, \epsilon]$ and $L_b = \{b\} \times [0, \epsilon]$ we have

$$\Psi(L_a) \cap \overline{W^{u+}(p)} = \Psi(L_b) \cap \overline{W^{u+}(p)} = \emptyset.$$

Then if we let $L_a^n = A^n(L_a) \cap B_1$ and $L_b^n = A^n(L_b) \cap B_1$, we have

$$\Psi(L_a^n) \cap \overline{W^{u+}(p)} = \Psi(L_b^n) \cap \overline{W^{u+}(p)} = \emptyset,$$

since $\overline{W^{u+}(p)}$ is invariant under F .

Again hyperbolicity of F at p guarantees that there exists $n(r)$ such that L_a^n separates $\{0\} \times [0, 1]$ from $\{r\} \times [0, 1]$ in B_1 and L_b^n separates $\{0\} \times [0, 1]$ from $\{-r\} \times [0, 1]$ in B_1 .

Let Γ be the rectangle made of the union of the four segments $[-r, r] \times y_i$ ($i = 1, 3$), $L_a^n \cap [-1, 1] \times [y_1, y_3]$ and $L_b^n \cap [-1, 1] \times [y_1, y_3]$ (see [Figure 5.8](#)). Then Γ separates the points $(0, y_2)$ and $(0, y_4)$, which contradicts the connectedness of $F^{-N}(H)$ and therefore of H . \square

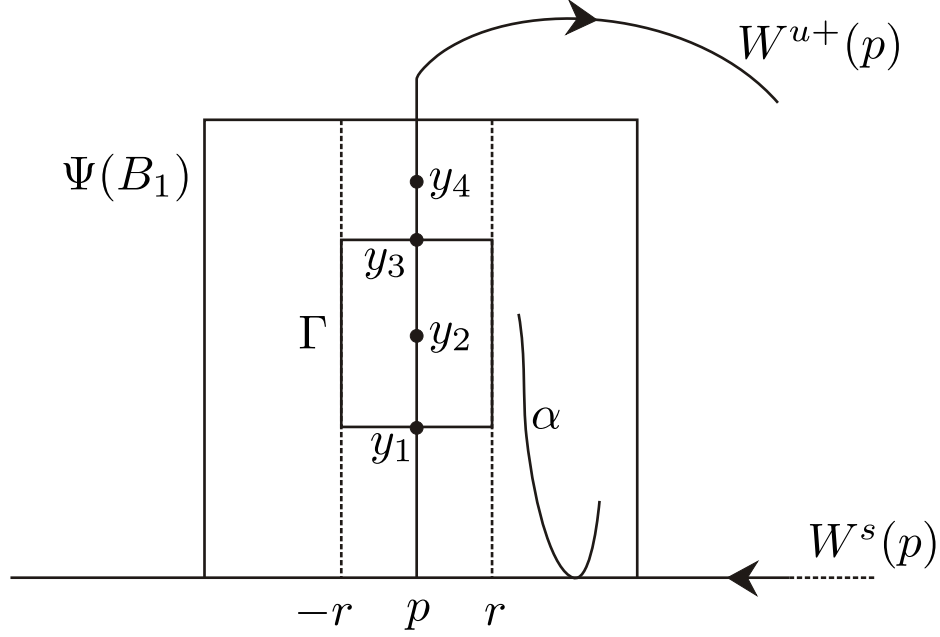

Figure 5.8:

Theorem 5.9 (Barge). *Let $F : \mathbb{R}^2 \rightarrow \mathbb{R}^2$ be a C^1 -diffeomorphism with hyperbolic fixedpoint p such that $\overline{W^{u+}(p)}$ is an indecomposable continuum and*

$$\overline{W^{u+}(p)} \cap W^s(p) \subset W^{u+}(p)$$

Then for no continuous map f of a branched one-manifold K is the restriction of F to $\overline{W^{u+}(p)}$ topologically conjugate to the induced map \hat{f} .

Proof. Suppose there is a branched one-manifold K , a continuous map $f : K \rightarrow K$ and a homeomorphism h from $W^{u+}(p)$ onto (K, f) such that $h^{-1} \circ f \circ h = F$. Without loss of generality, we may assume that f is onto (otherwise replace K by $L = \bigcap_{n \geq 0} f^n(K)$).

(1) Since $W^{u+}(p) = \bigcup_{n \geq 0} \phi([0, n])$, the composant C_p of p in $\overline{W^{u+}(p)}$ contains $W^{u+}(p)$. Hence $W^s(p) \cap \overline{W^{u+}(p)}$ which is the stable set of p in $\overline{W^{u+}(p)}$ is contained in C_p and thus, $S(h(p))$, the stable set of $h(p)$ in (K, f) is contained in $C_{h(p)}$.

(2) It is clear from the definition of a branched one-manifold, that there exist an $l \in \mathbb{N}$ such any collection of l distinct points in K destroys the connectivity of K . Let $h(p) = (p_0, p_0, \dots)$ ($p_0 \in K$) and $\mathbf{x} = (x_0, x_1, \dots) \in S(h(p)) - \{h(p)\}$. Then $\mathbf{x}, \hat{f}(\mathbf{x}), \dots, \hat{f}^{l-1}(\mathbf{x})$ are l distinct points in $S(h(p))$. Thus, there exists $N \geq 0$ such that

$$\pi_N(\hat{f}^i(\mathbf{x})) \neq \pi_N(\hat{f}^j(\mathbf{x}))$$

for $0 \leq i < j \leq l-1$ (where $\pi_N : (X, f) \rightarrow K$ is the projection onto the N -th coordinate). Therefore,

$$K - \{\pi_N(\mathbf{x}), \pi_N(\hat{f}(\mathbf{x})), \dots, \pi_N(\hat{f}^{l-1}(\mathbf{x}))\} = K - \{x_N, f(x_N), \dots, f^{l-1}(x_N)\}$$

is not connected.

(3) Since (K, f) is indecomposable, there exists at least one composant C in (K, f) such that $C \cap C_{h(p)} = \emptyset$. But C is dense in (K, f) and connected so $\pi_n(C)$ is dense and connected in K . Hence $\pi_N(C) \cap \{x_N, f(x_N), \dots, f^{l-1}(x_N)\} \neq \emptyset$. Therefore, it is possible to find $\mathbf{y} = (y_0, y_1, \dots) \in C$ with $\pi_N(\mathbf{y}) = y_N = f^i(x_N)$ for some $0 \leq i \leq l-1$. But then

$$\lim_{n \rightarrow +\infty} f^n(y_0) = \lim_{n \rightarrow +\infty} f^{n+N}(f^i(x_N)) = \lim_{n \rightarrow +\infty} f^{n+i}(x_0) = p_0$$

so that $y \in S(h(p)) \subset C_p$ which gives a contradiction. □

Exercises

Exercise 5.1. Show that the unstable set of 0 in [Theorem 5.3](#) is a continuous, one-to-one image of the real line.

Bibliography

- [1] B. J. Ball. Arcwise connectedness and the persistence of errors. *Amer. Math. Monthly*, 91(7):431–433, 1984.
- [2] M. Barge. Horseshoe maps and inverse limits. *Pacific J. Math.*, 121(1):29–39, 1986.
- [3] M. Barge. Homoclinic intersections and indecomposability. *Proc. Amer. Math. Soc.*, 101(3):541–544, 1987.
- [4] M. Barge and R. M. Gillette. Rotation and periodicity in plane separating continua. *Ergodic Theory Dynam. Systems*, 11(4):619–631, 1991.
- [5] R. H. Bing. Concerning hereditarily indecomposable continua. *Pacific J. Math.*, 1:43–51, 1951.
- [6] S. S. Cairns. An elementary proof of the Jordan-Schoenflies theorem. *Proc. Amer. Math. Soc.*, 2:860–867, 1951.
- [7] R. L. Devaney. *An introduction to chaotic dynamical systems*. Studies in Nonlinearity. Westview Press, Boulder, CO, 2003.
- [8] C. L. Hagopian. A characterization of solenoids. *Pacific J. Math.*, 4:425–435, 1937.
- [9] J. G. Hocking and G. S. Young. *Topology*. Dover Publications Inc., New York, 1988.
- [10] B. Kerékjártó. *Topologie*. Springer, Berlin, 1923.
- [11] K. Kuratowski. Sur les copures irréductibles du plan. *Fund. Math.*, 6:120–145, 1924.
- [12] K. Kuratowski. *Topology. Vol. II*. New edition, revised and augmented. Translated from the French by A. Kirkor. Academic Press, New York, 1968.
- [13] R. Maehara. The Jordan curve theorem via the Brouwer fixed point theorem. *Amer. Math. Monthly*, 91(10):641–643, 1984.
- [14] E. E. Moise. An indecomposable plane continuum which is homeomorphic to each of its nondegenerate subcontinua. *Trans. Amer. Math. Soc.*, 63:581–594, 1948.
- [15] S. B. Nadler, Jr. *Continuum theory*, volume 158 of *Monographs and Textbooks in Pure and Applied Mathematics*. Marcel Dekker Inc., New York, 1992.
- [16] M. H. A. Newman. *Elements of the topology of plane sets of points*. Dover Publications Inc., New York, 1992.
- [17] M. Shub. *Global stability of dynamical systems*. Springer-Verlag, New York, 1987.
- [18] C. Thomassen. The Jordan-Schönflies theorem and the classification of surfaces. *Amer. Math. Monthly*, 99(2):116–130, 1992.

- [19] H. Tverberg. A proof of the Jordan curve theorem. *Bull. London Math. Soc.*, 12(1):34–38, 1980.
- [20] T. West, editor. *Continuum theory and dynamical systems*, volume 149 of *Lecture Notes in Pure and Applied Mathematics*. Marcel Dekker Inc., New York, 1993.
- [21] G. T. Whyburn. *Topological analysis*. Second, revised edition. Princeton Mathematical Series, No. 23. Princeton University Press, Princeton, N.J., 1964.
- [22] R. F. Williams. One-dimensional non-wandering sets. *Topology*, 6:473–487, 1967.
- [23] K. Yoneyama. Theory of continuous sets of points. *Tohoku Math. J.*, 11-12:43–158, 1917.

Thanks

I express my gratitude to Lucien Guillou and Marie-Christine Pérouème for their help during the preparation of these notes and William Bonnaz for the drawings.