



HAL
open science

Principles of Kelvin Probe Force Microscopy and applications

Laurent Nony

► **To cite this version:**

Laurent Nony. Principles of Kelvin Probe Force Microscopy and applications. DEA. Laurent NONY, 1st German-French Summer School on noncontact -AFM Porquerolles, 6th-11th 2013, France, 2013, pp.80. cel-00917935

HAL Id: cel-00917935

<https://cel.hal.science/cel-00917935>

Submitted on 12 Dec 2013

HAL is a multi-disciplinary open access archive for the deposit and dissemination of scientific research documents, whether they are published or not. The documents may come from teaching and research institutions in France or abroad, or from public or private research centers.

L'archive ouverte pluridisciplinaire **HAL**, est destinée au dépôt et à la diffusion de documents scientifiques de niveau recherche, publiés ou non, émanant des établissements d'enseignement et de recherche français ou étrangers, des laboratoires publics ou privés.

PRINCIPLES OF KELVIN PROBE FORCE MICROSCOPY AND APPLICATIONS

Laurent NONY

Aix-Marseille Université, Faculté des Sciences, site Etoile - Saint-Jérôme
IM2NP, UMR CNRS 7334
Marseille, France

laurent.nony@im2np.fr

1st German-French Summer School on noncontact -AFM
Porquerolles, 6th-11th of October 2013, France



Institut Matériaux Microélectronique Nanosciences de Provence
UMR CNRS 7334, Universités Aix-Marseille et Sud Toulon-Var



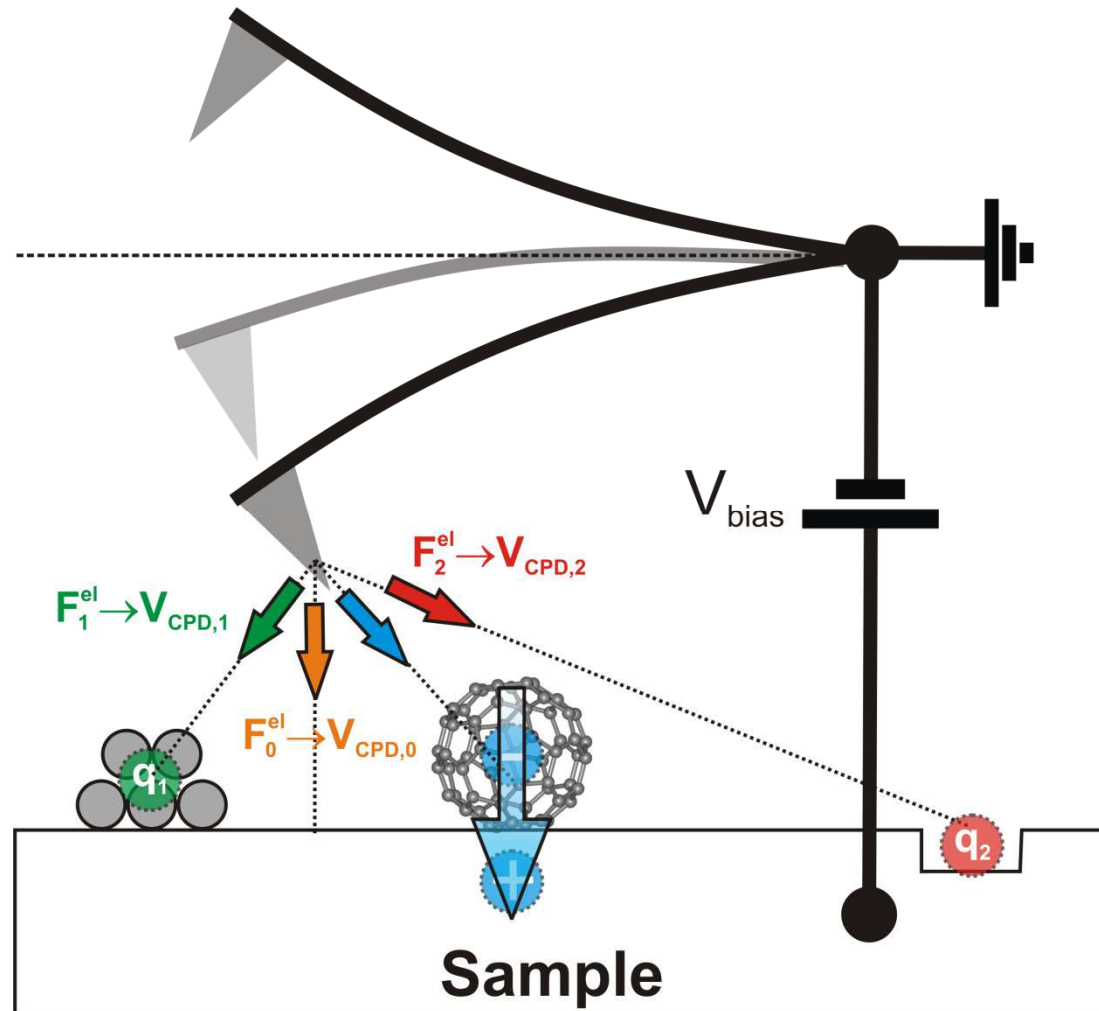

- ☐ Forces:
- VdW
 - Chemical
 - Magnetic
 - **Electrostatic**

KPFM \rightarrow Electrostatic force compensation $\rightarrow V_{\text{bias}} \rightarrow$ Models to quantitative estimates

Outline

I. INTRODUCTION

- Electrostatic forces & Contact Potential Difference (CPD)

II. PRINCIPLES OF KPFM

- Fundamentals of KPFM
- KPFM operational mode: FM and AM mode

III. ELECTROSTATIC MODELS

- Single charge trapped within a capacitor
- Assemblies of charge on a bulk insulator

IV. APPLICATIONS

- Metals including charged adsorbates
- Bulk insulators with and without charged adsorbates

V. HIGH-RESOLUTION KPFM

- Short-range electrostatic forces & concept of Local CPD (LCPD)

CONCLUSION

I. Introduction

Electrostatic forces: macroscopic concept

□ Parallel-plate capacitor:

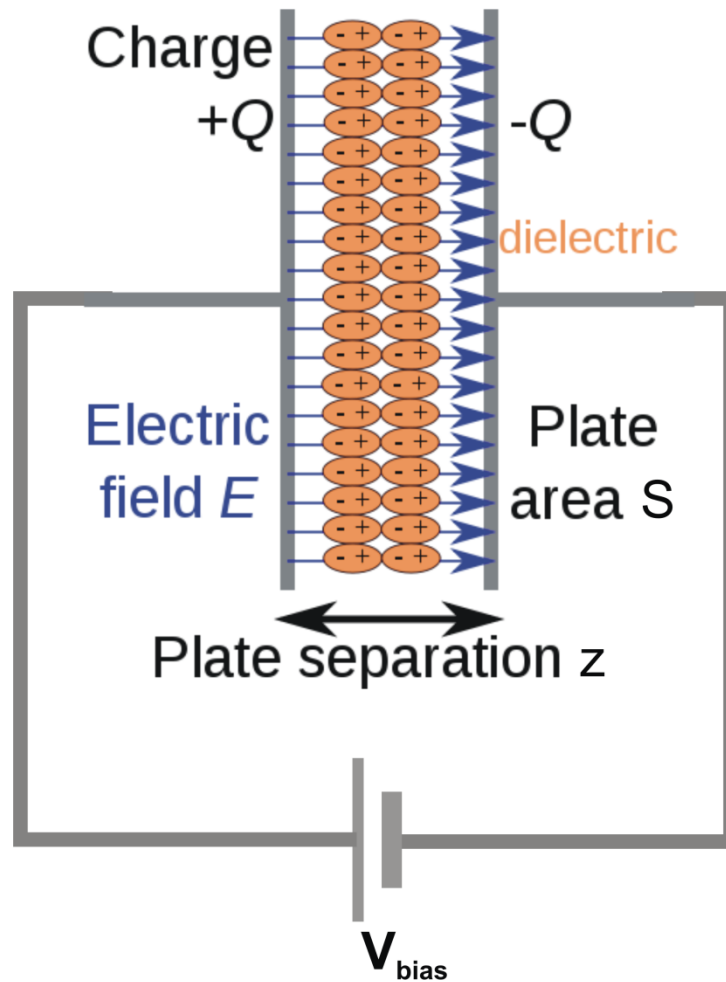

□ Capacitance C:

$$C = \frac{\epsilon_0 \epsilon_r S}{z} = \frac{Q}{V_{\text{bias}}}$$

□ Time dependence:

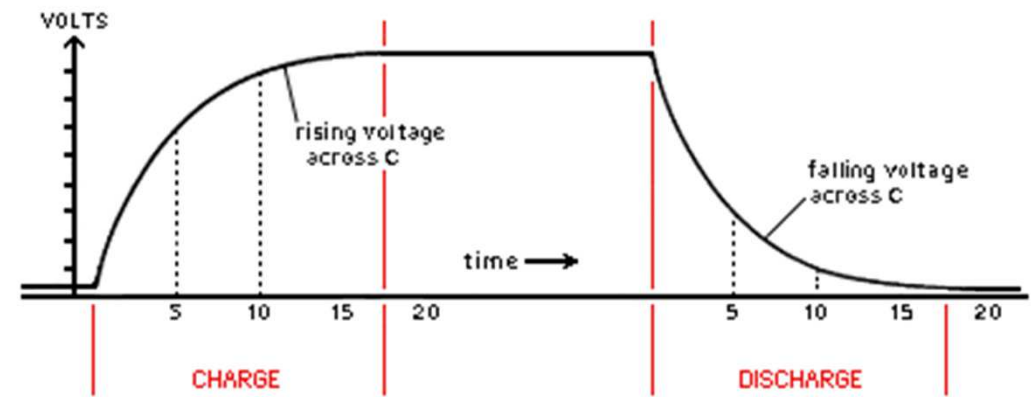

Electrostatic forces: macroscopic concept



William Thomson (later Lord Kelvin of Largs):
1824 (Belfast, Ireland) - 1907 (Largs, UK)

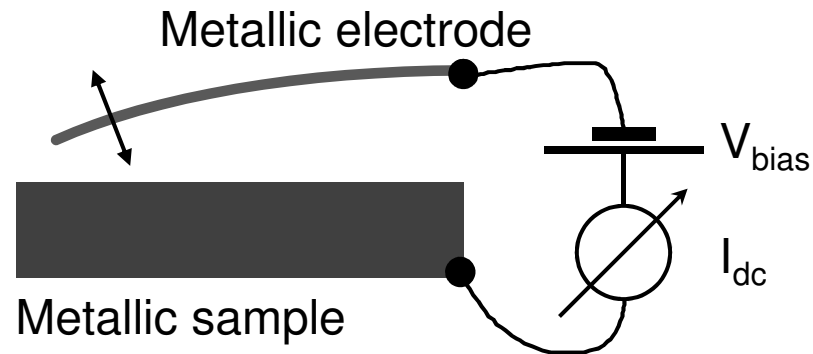

$$I_{\text{dc}} = \frac{dC}{dt} (V_{\text{bias}} - V_{\text{offs}})$$

*Lord Kelvin, *Phil. Mag.* **46**, 82 (1898)

Electrostatic forces: macroscopic concept

- Electrostatic force acting on the plates of a charged parallel-plate capacitor:

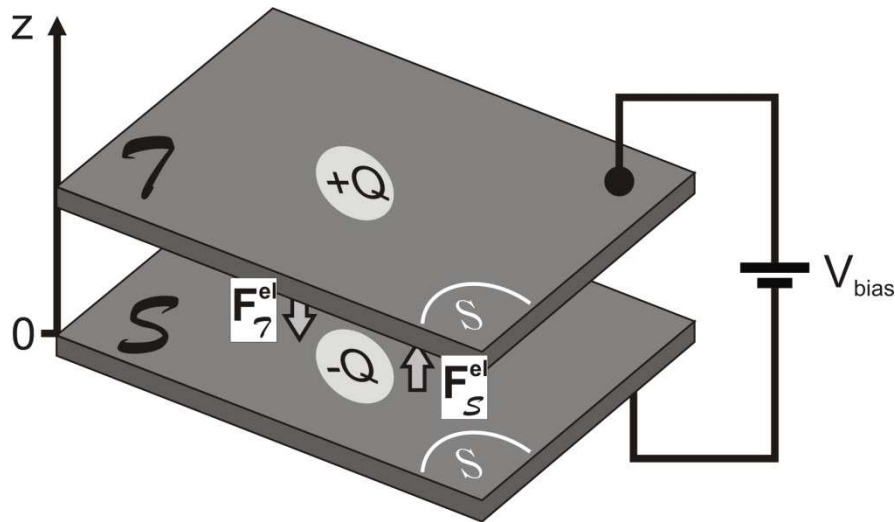

$$W^{\text{el}} = \frac{1}{2} Q V_{\text{bias}} = \frac{1}{2} C V_{\text{bias}}^2$$

$$\mathbf{F}_{\mathcal{T}}^{\text{el}} = + \frac{\partial W^{\text{el}}}{\partial z} \hat{\mathbf{z}} = + \frac{1}{2} \frac{\partial C}{\partial z} V_{\text{bias}}^2 \hat{\mathbf{z}}$$

(attractive! because the gradient of C is <0)

$$\text{Here: } \mathbf{F}_{\mathcal{T}}^{\text{el}} = - \frac{1}{2} \frac{\epsilon_0 \epsilon_r S}{z^2} V_{\text{bias}}^2 \hat{\mathbf{z}}$$

- Electrostatic force acting on an electrode of any kind:

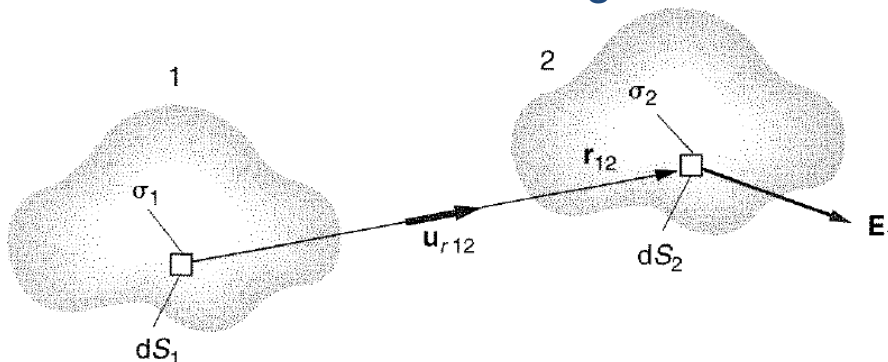

$$\mathbf{F}_{1 \rightarrow 2}^{\text{el}} = - \oint_{S_2} \sigma_2 dS_2 \mathbf{E}_1$$

Surface dipole & work function in metals

K. Wandelt, *Appl. Surf. Sci.* 111, 1 (1997)

"The work function φ of an **infinite homogeneous metal** surface is defined as the energy difference between... the Fermi level... and a final state... the so called vacuum level."

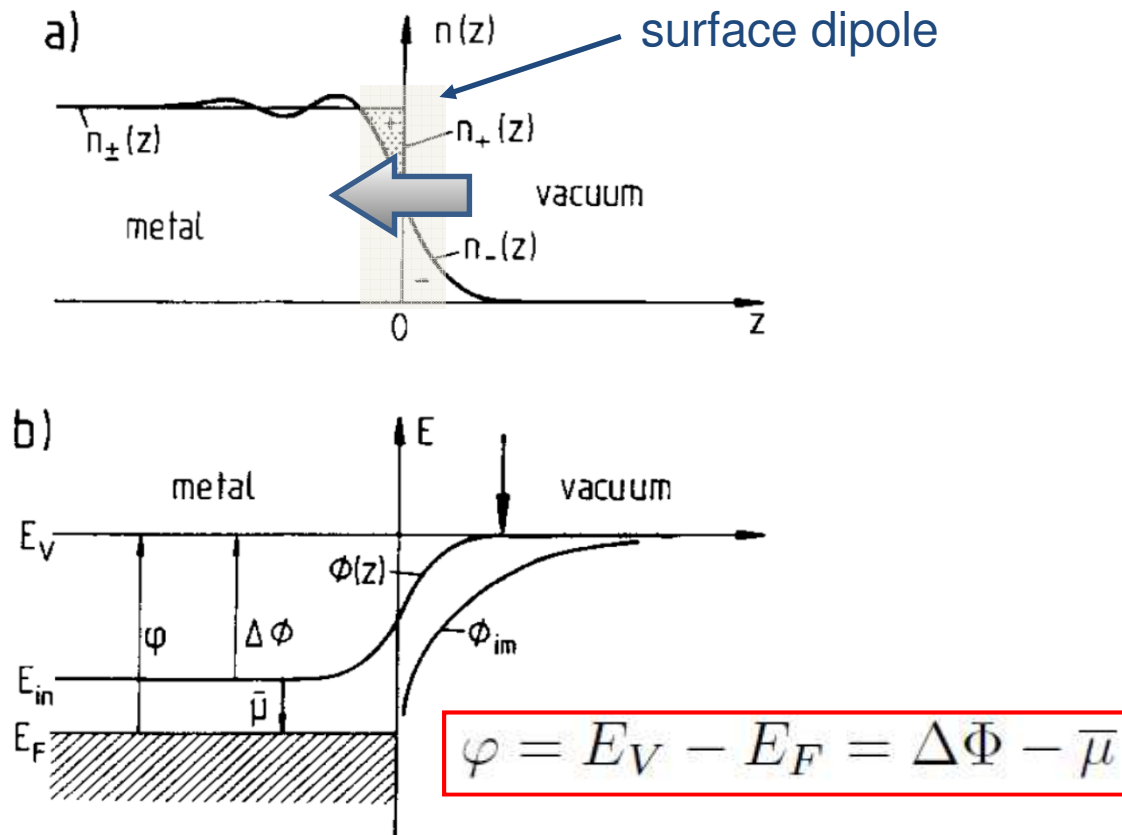

Electrostatic forces and Contact Potential Difference (CPD)

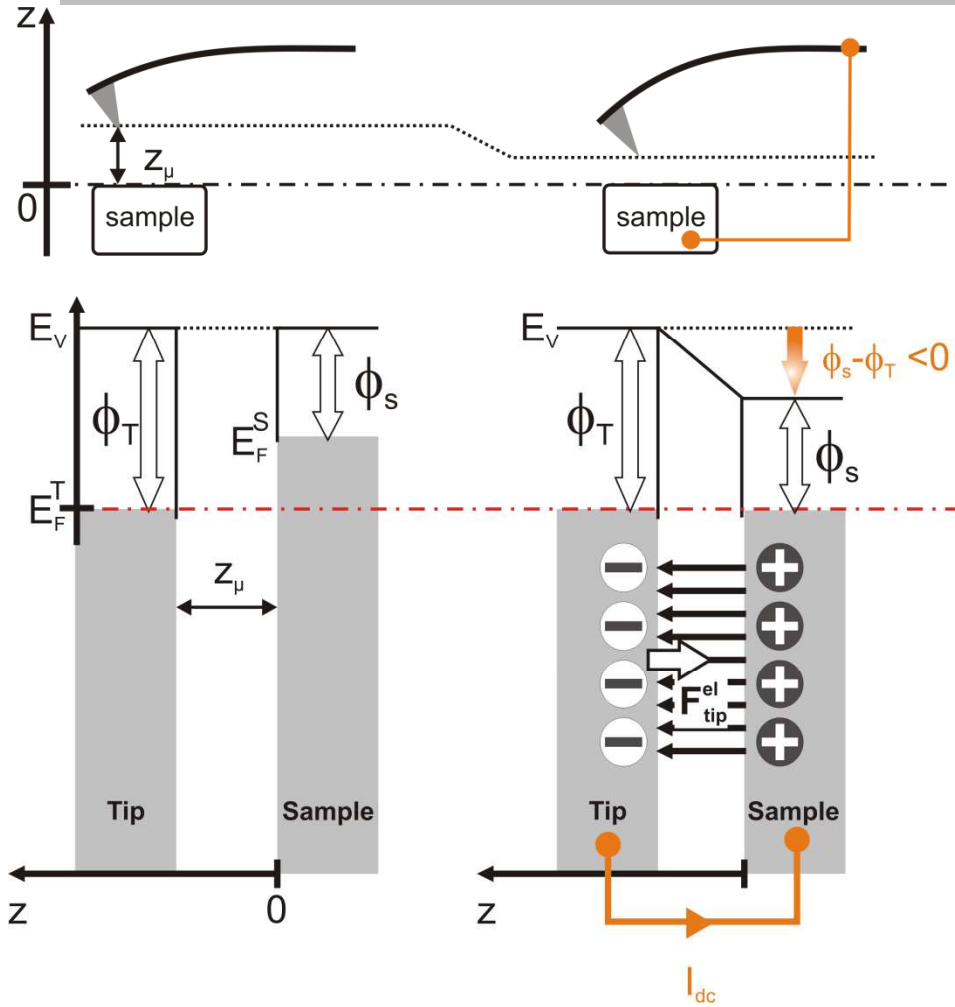

$$V_{CPD} = \frac{\Delta\Phi}{|e|} = \frac{\Phi_{sample} - \Phi_{tip}}{|e|}$$

(< 0 , in the present case)

Electrostatic forces and Contact Potential Difference (CPD)

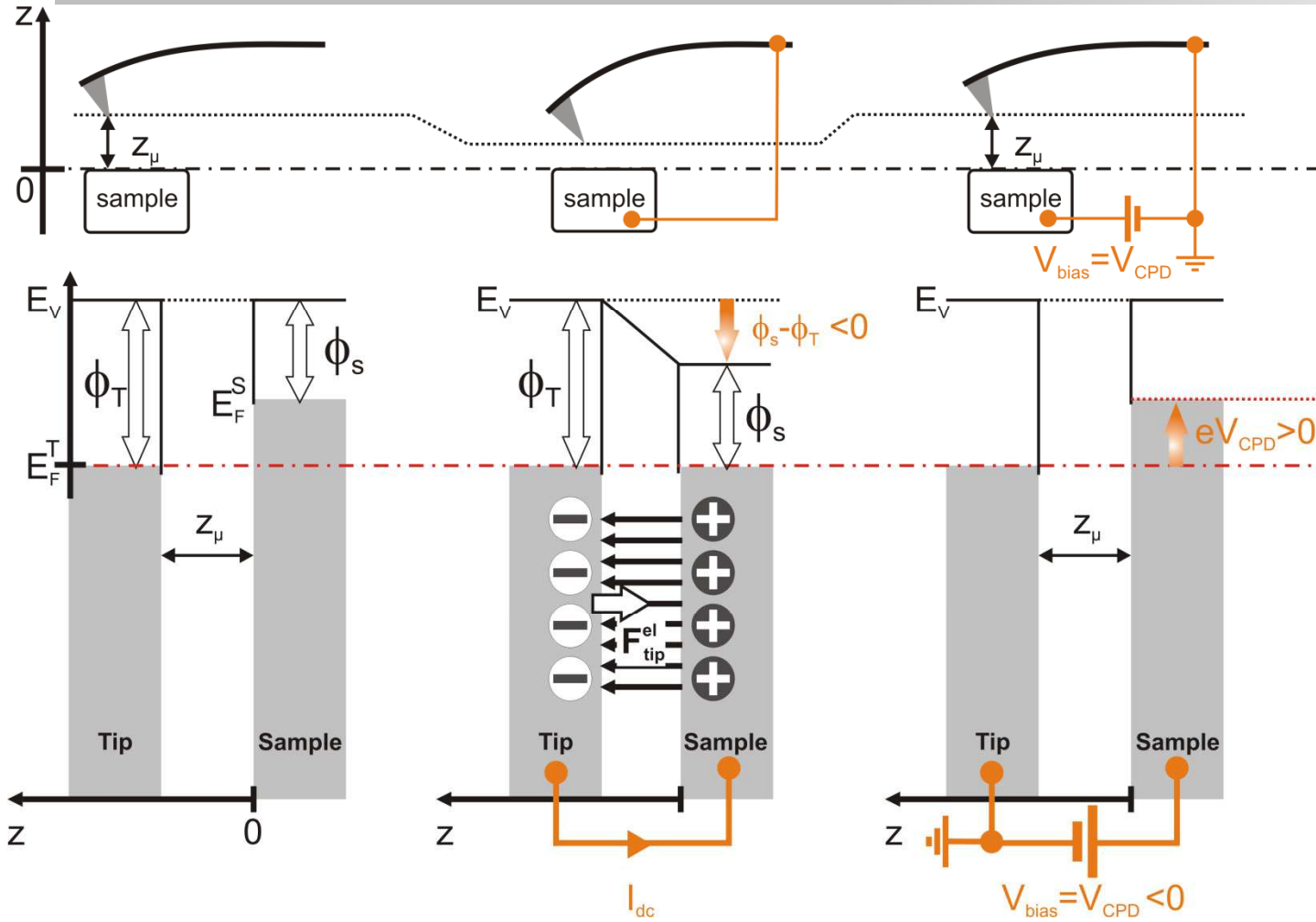

$V_{bias} = V_{CPD} \rightarrow$ electrostatic force compensation

Electrostatic forces and Contact Potential Difference (CPD)

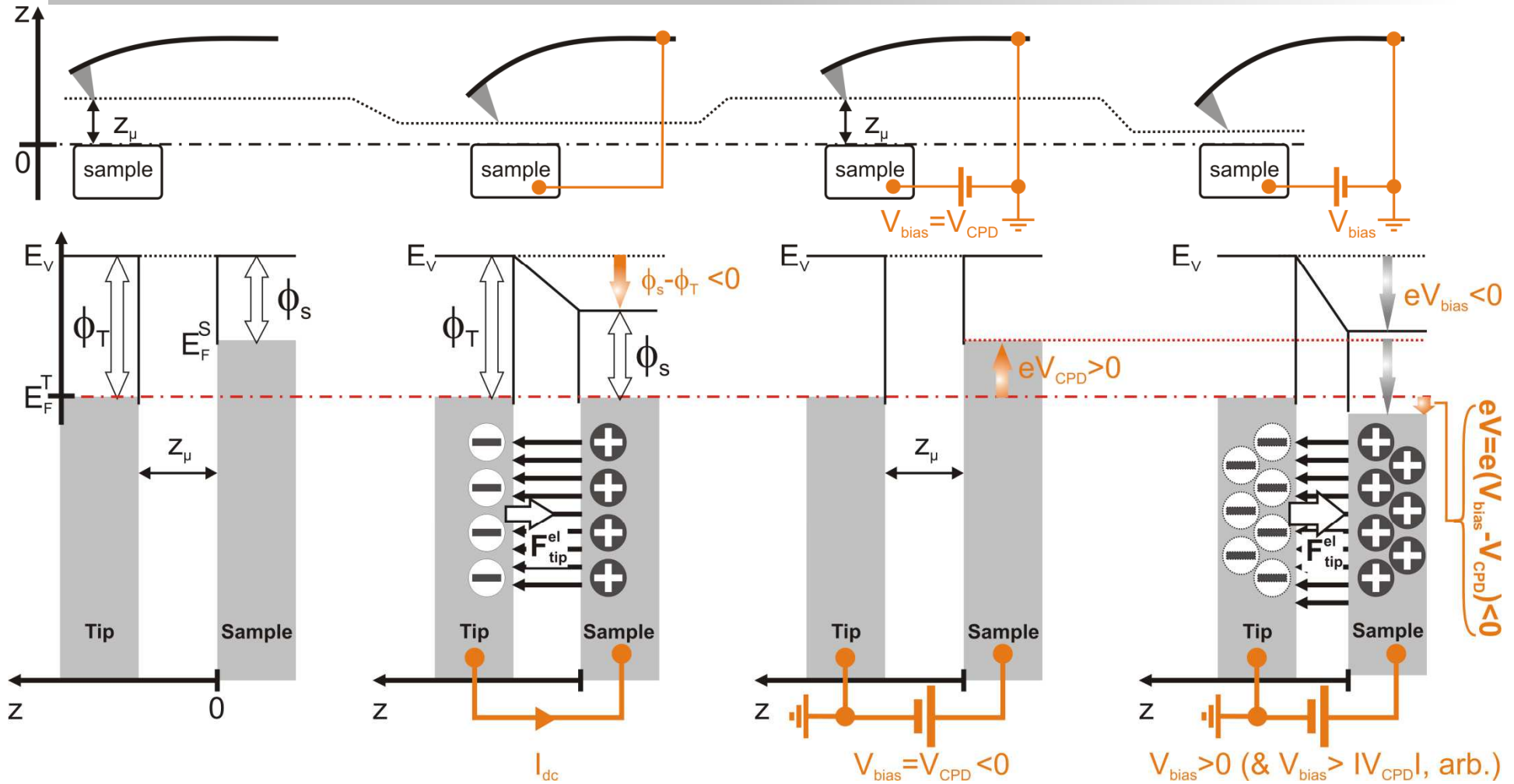

$$\mathbf{F}_{tip}^{el} = + \frac{\partial W^{el}}{\partial z} \hat{\mathbf{z}} = + \frac{1}{2} \frac{\partial C}{\partial z} V^2 \hat{\mathbf{z}} = + \frac{1}{2} \frac{\partial C}{\partial z} (V_{bias} - V_{CPD})^2 \hat{\mathbf{z}}$$

Electrostatic forces and Contact Potential Difference (CPD)

$$\mathbf{F}_{\text{tip}}^{\text{el}} = + \frac{\partial W^{\text{el}}}{\partial z} \hat{\mathbf{z}} = + \frac{1}{2} \frac{\partial C}{\partial z} V^2 \hat{\mathbf{z}} = + \frac{1}{2} \frac{\partial C}{\partial z} (V_{\text{bias}} - V_{\text{CPD}})^2 \hat{\mathbf{z}}$$

- The essence of KPFM is to detect electrostatic forces between tip and surface and to compensate them by applying the proper dc bias on the sample during scanning :

$$F_{\text{tip}}^{\text{el}} = 0 \Leftrightarrow V_{\text{bias}} = V_{\text{CPD}}$$

- This is why KPFM may be used on any kind of surfaces: metals, semi-conductors & insulators, despite with the former the concept of CPD is ambiguous...

Electrostatic forces and Contact Potential Difference (CPD)

$$\mathbf{F}_{\text{tip}}^{\text{el}} = + \frac{\partial W^{\text{el}}}{\partial z} \hat{\mathbf{z}} = + \frac{1}{2} \frac{\partial C}{\partial z} V^2 \hat{\mathbf{z}} = + \frac{1}{2} \frac{\partial C}{\partial z} (V_{\text{bias}} - V_{\text{CPD}})^2 \hat{\mathbf{z}}$$

- Electr. forces may either stem from charges or dipoles (ions, vacancies, clusters, charge transfer within molecules...) at the tip-surface interface

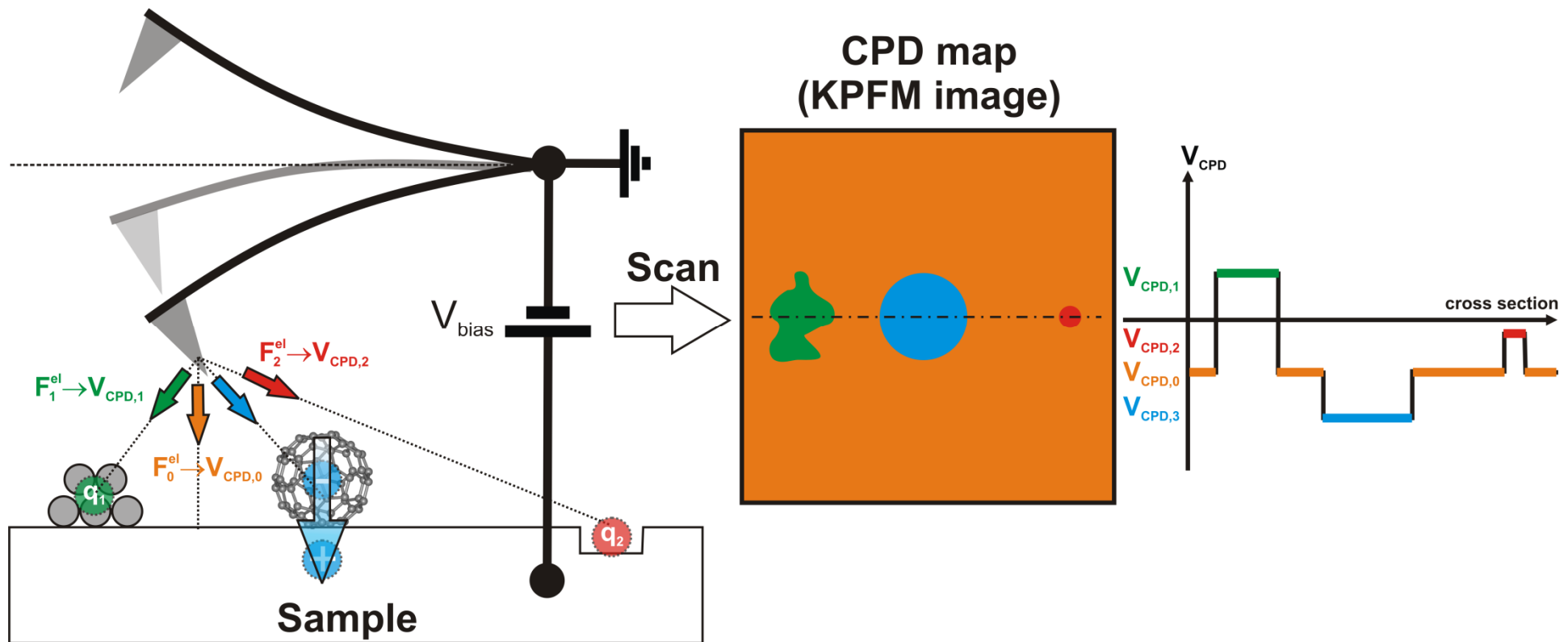

Electrostatic forces and Contact Potential Difference (CPD)

$$\mathbf{F}_{\text{tip}}^{\text{el}} = + \frac{\partial W^{\text{el}}}{\partial z} \hat{\mathbf{z}} = + \frac{1}{2} \frac{\partial C}{\partial z} V^2 \hat{\mathbf{z}} = + \frac{1}{2} \frac{\partial C}{\partial z} (V_{\text{bias}} - V_{\text{CPD}})^2 \hat{\mathbf{z}}$$

- Therefore, KPFM was thought as a mean to measure CPD* variations between tip and surface:

$$F_{\text{tip}}^{\text{el}} = 0 \Leftrightarrow V_{\text{bias}} = V_{\text{CPD}}$$

- **BUT** this relies on two (major) assumptions:
 - the force must depend quadratically on the effective applied bias V
 - V (hence, V_{CPD}) must not depend on z

* only if the tip is grounded and V is applied to the sample, $V_{\text{bias}} = -V_{\text{CPD}}$ otherwise

Sign of the charge & dipole orientation*

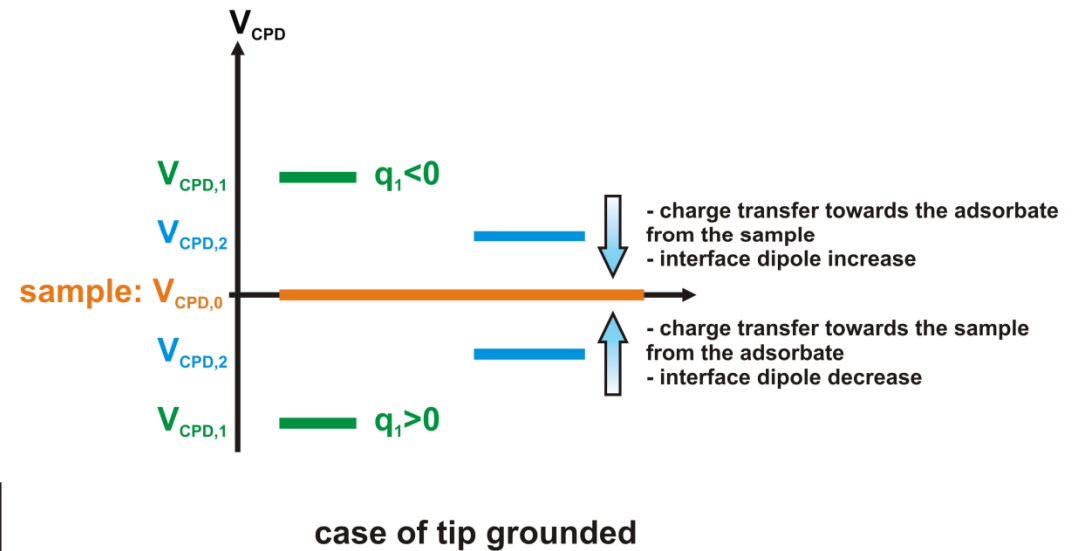
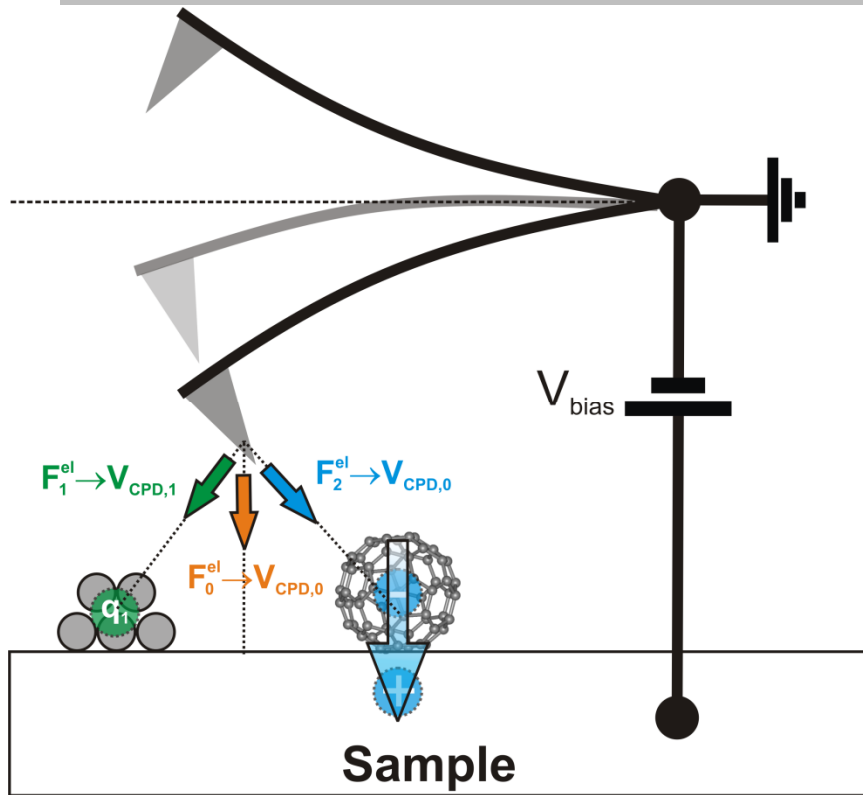

- $q > 0$ (< 0): negative (positive) shift of V_{CPD} w.r.t. $V_{CPD,ref}$
- \uparrow (\downarrow) : negative (positive) shift of V_{CPD} w.r.t. $V_{CPD,ref}$

*consistent with most frequently reported results (see « References » section at the end of the slides)

Example

□ ZnPcCl₈ on Ag(111)¹:

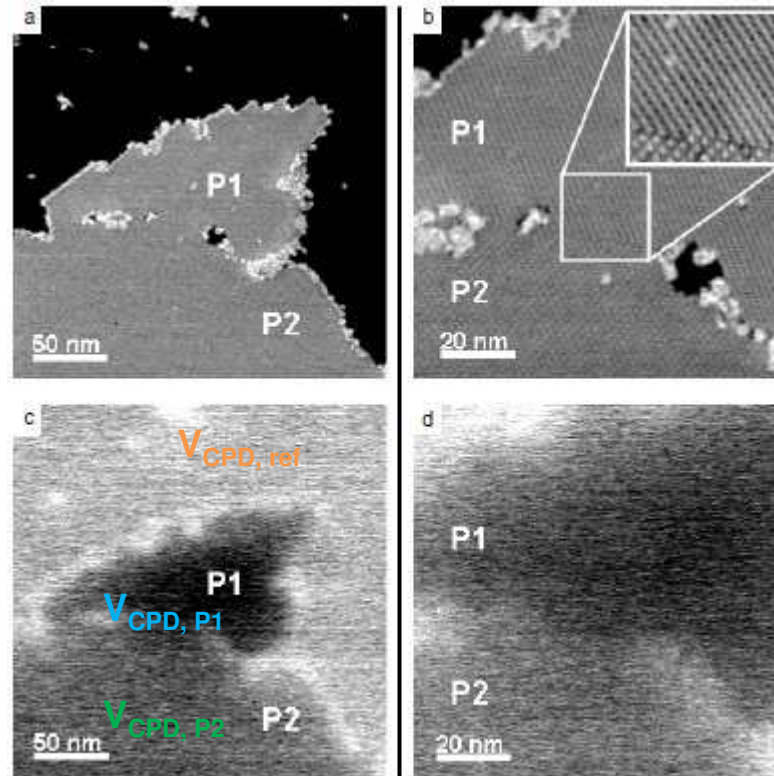
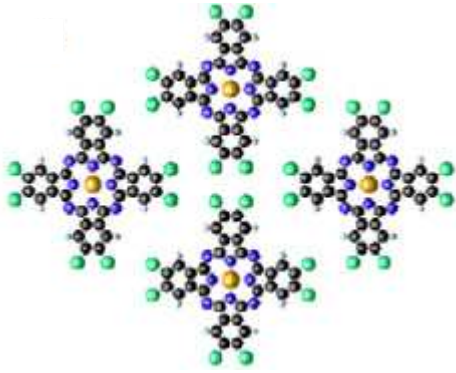

- $V_{\text{CPD, ref}} = 4.73 \text{ V}$
- $V_{\text{CPD, P1}} = V_{\text{CPD, ref}} - 103 \text{ mV} \rightarrow$ interf. dip. decreased \rightarrow c.t. to the sample \rightarrow layer gets + charged
- $V_{\text{CPD, P2}} = V_{\text{CPD, ref}} - 54 \text{ mV} \rightarrow$ idem, but less than with P1

¹P. Milde *et al.* Nanotechnology 19, 305501 (2008)

II. Principles of KPFM

Concepts of non contact-AFM

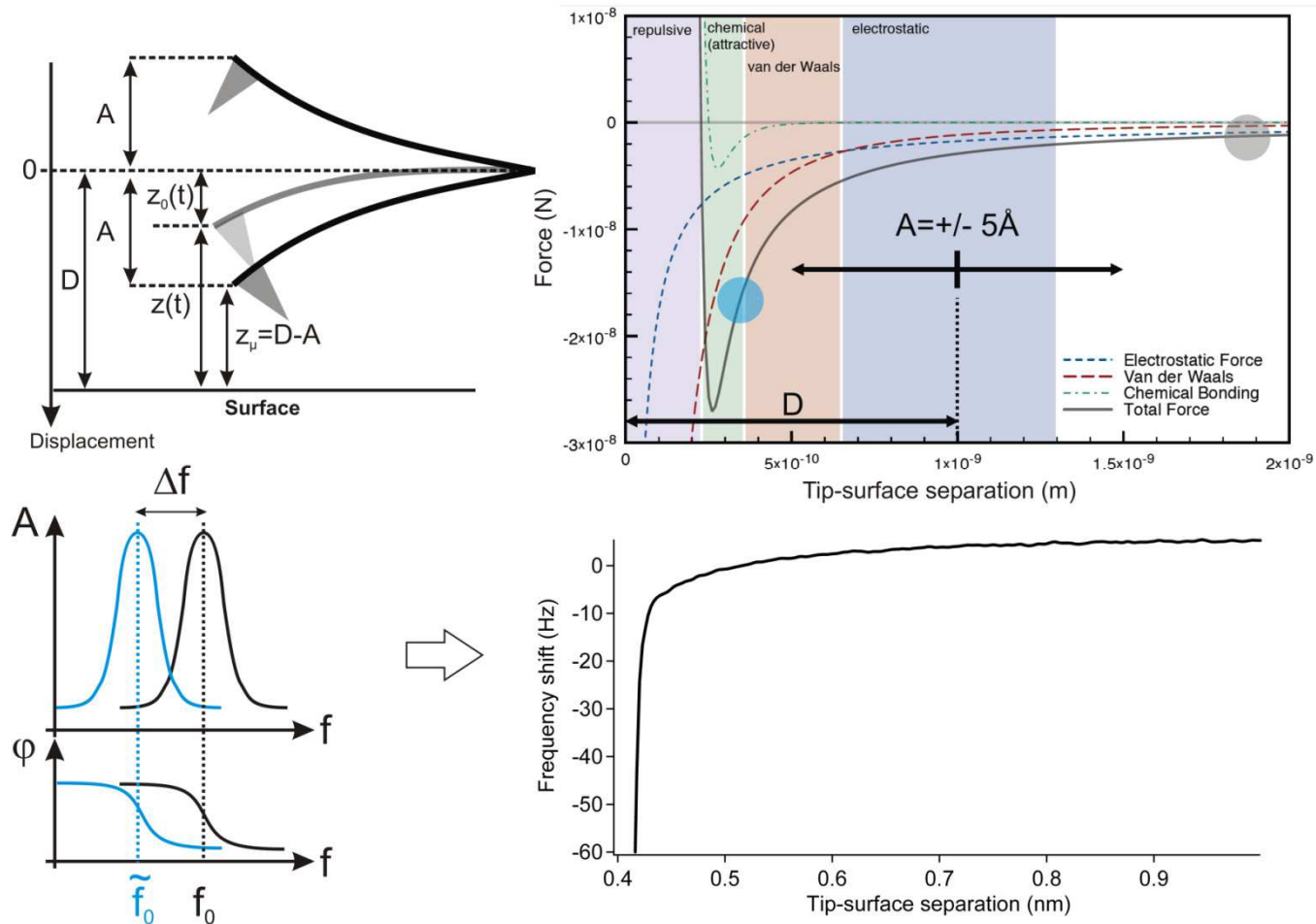

$$\frac{\Delta f(z_\mu)}{f_0} = \frac{\langle F_{int}^c \rangle}{k_0 A_0} = \frac{1}{2\pi k_0 A_0} \int_0^{2\pi} F_{int}^c(z_\mu + A_0 - A_0 \cos(u)) \cos(u) du$$

F.Giessibl, Phys Rev. B 56, 16010 (1997); Phys. Rev.B 61, 9968 (2000)

Concepts of non contact-AFM

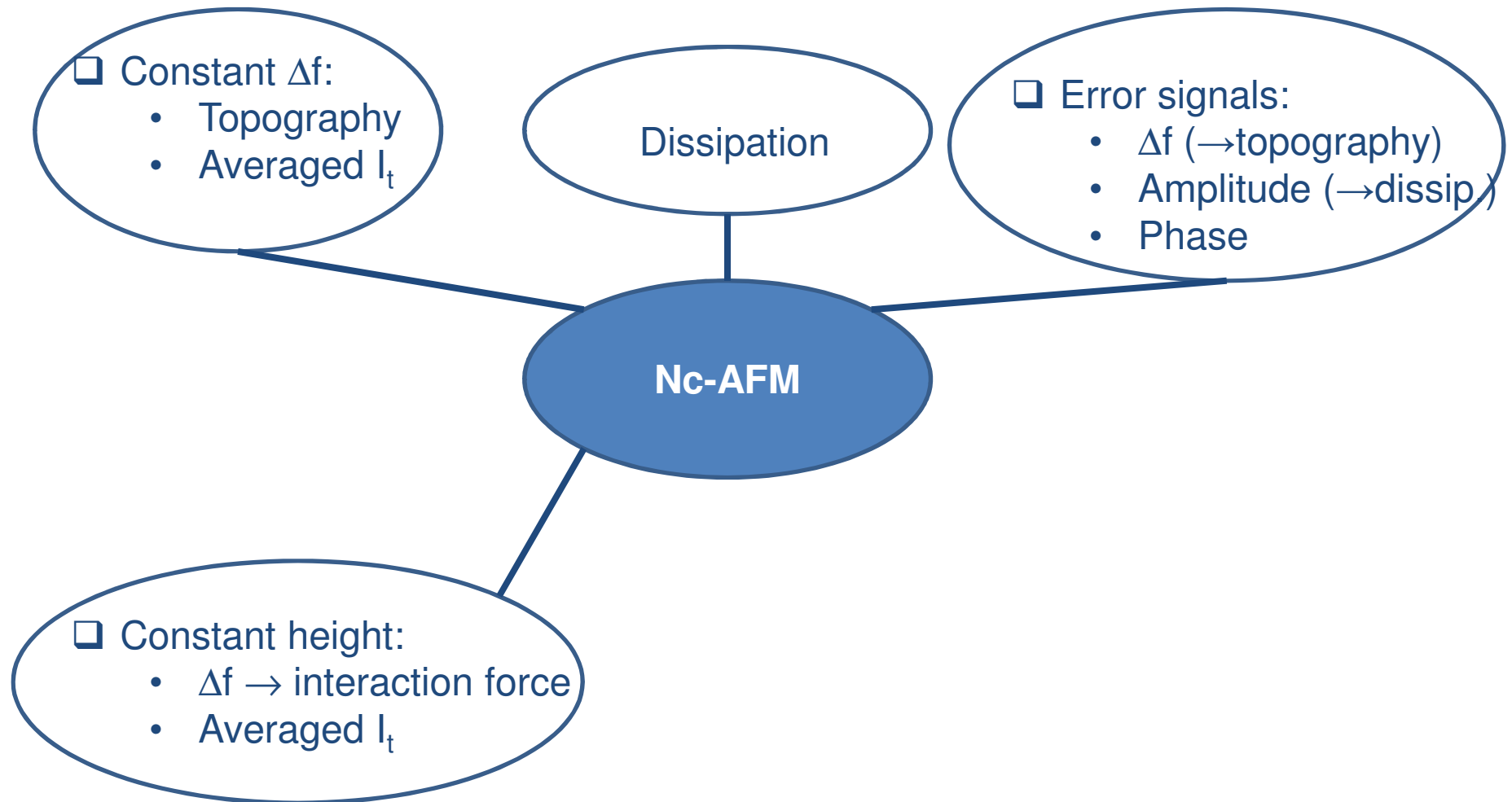

Fundamentals of KPFM (in connection with nc-AFM)

Total interaction force between the cantilever and the surface
(4D: X, Y, Z, V_{bias})

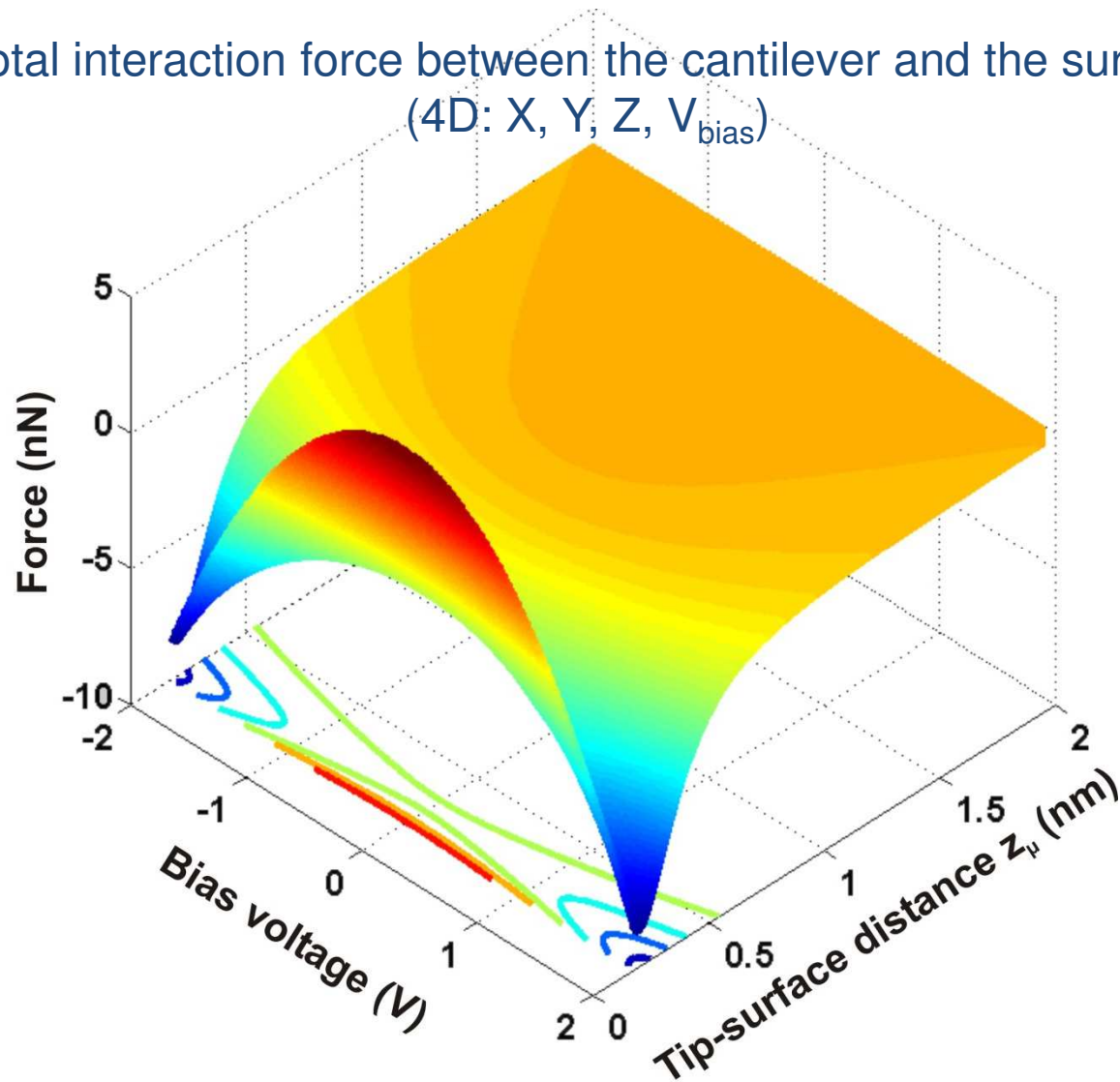

Fundamentals of KPFM (in connection with nc-AFM)

Ideally, the only option to perform accurate and « instrumentation-free » forces & CPD measurements is to do 4D force fields measurements:

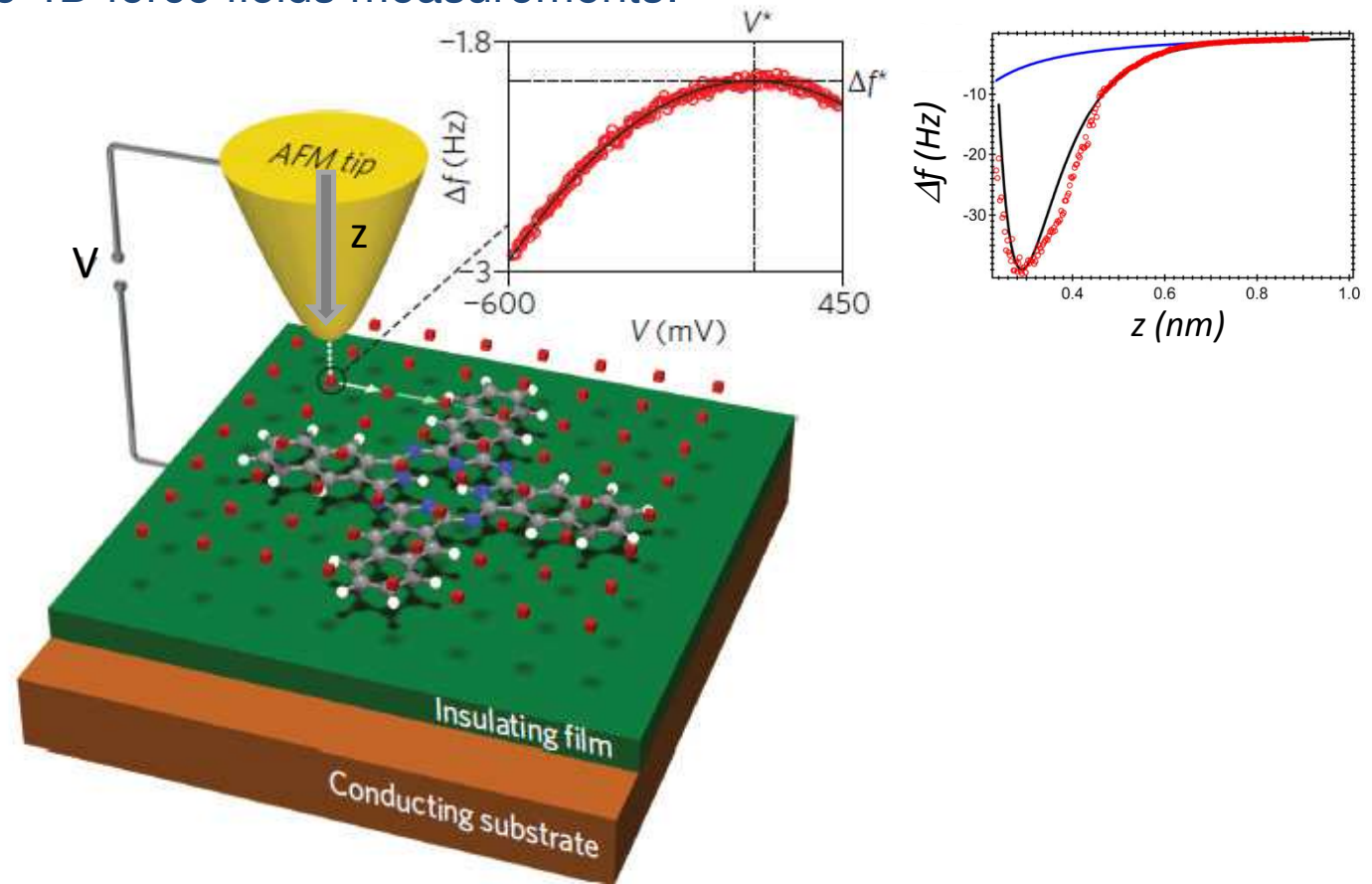

but « ideal situations » don't exist...

Concepts of non contact-AFM

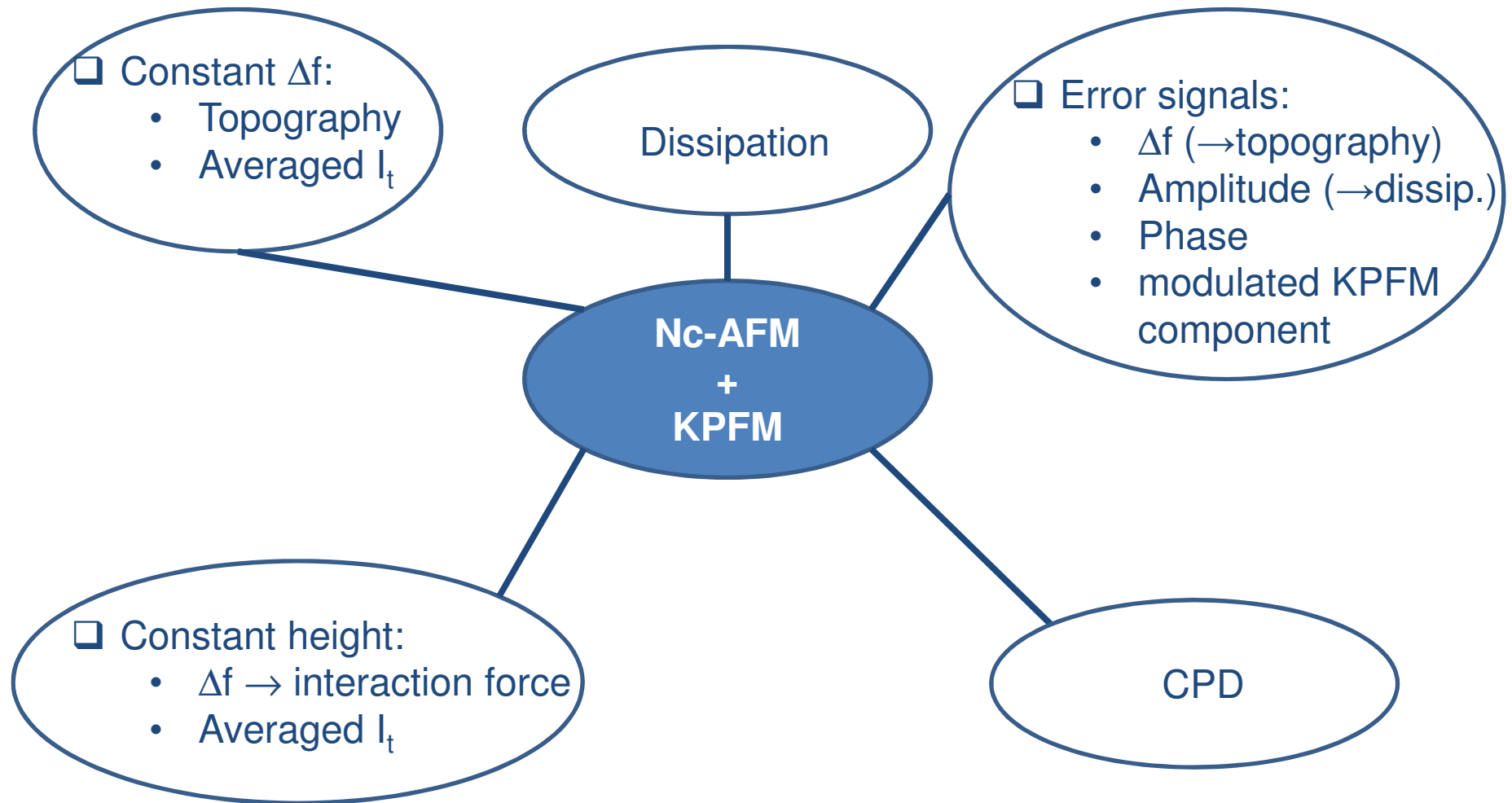

Fundamentals of KPFM (in connection with nc-AFM)

Idea¹ : bias modulation \Rightarrow discrimination of the electrostatic force w.r.t. other interaction forces

Bias voltage applied between the tip and the surface :

$$V_{bias} = V_{dc} + V_{ac} \sin(2\pi f_{mod} t)$$

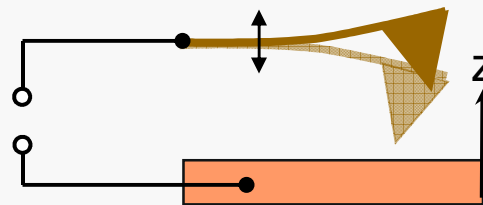

Noncontact-AFM:

Oscillation at f_0
(Force $\rightarrow \Delta f(z)$)

Attractive electrostatic force (tip):

$$F_{tip}^{el} = + \frac{1}{2} \frac{\partial C(z)}{\partial z} [V_{dc} - V_{CPD} + V_{ac} \sin(2\pi f_{mod} t)]^2$$

¹M. Nonnenmacher et al., APL **58**, 2921 (1991); J. Weaver et al. JVSTB **9**, 1559 (1991)

Fundamentals of KPFM (in connection with nc-AFM)

Spectral components:

$$\left\{ \begin{array}{l}
 F_{\text{tip}}^{\text{el},0} = \frac{\partial C(z)}{\partial z} \left[\frac{1}{2} (V_{\text{dc}} - V_{\text{CPD}})^2 + \frac{V_{\text{ac}}^2}{4} \right] \\
 F_{\text{tip}}^{\text{el},f_{\text{mod}}} = \frac{\partial C(z)}{\partial z} (V_{\text{dc}} - V_{\text{CPD}}) V_{\text{ac}} \sin(2\pi f_{\text{mod}} t) \\
 F_{\text{tip}}^{\text{el},2f_{\text{mod}}} = \frac{\partial C(z)}{\partial z} \frac{V_{\text{ac}}^2}{4} \cos(2f_{\text{mod}} t)
 \end{array} \right.$$

- ❑ These superimpose to the interaction force between the cantilever and the surface
- ❑ Static deflection & induced vibrations of the cantilever at $f_0 + f_{\text{mod}}$ and $f_0 + 2f_{\text{mod}}$
- ❑ Detection and cancellation of the f_{mod} component by applying a proper dc voltage which matches the CPD



Fundamentals of KPFM (in connection with nc-AFM)

Deflection power spectrum¹, $f_{\text{mod}}=2$ kHz

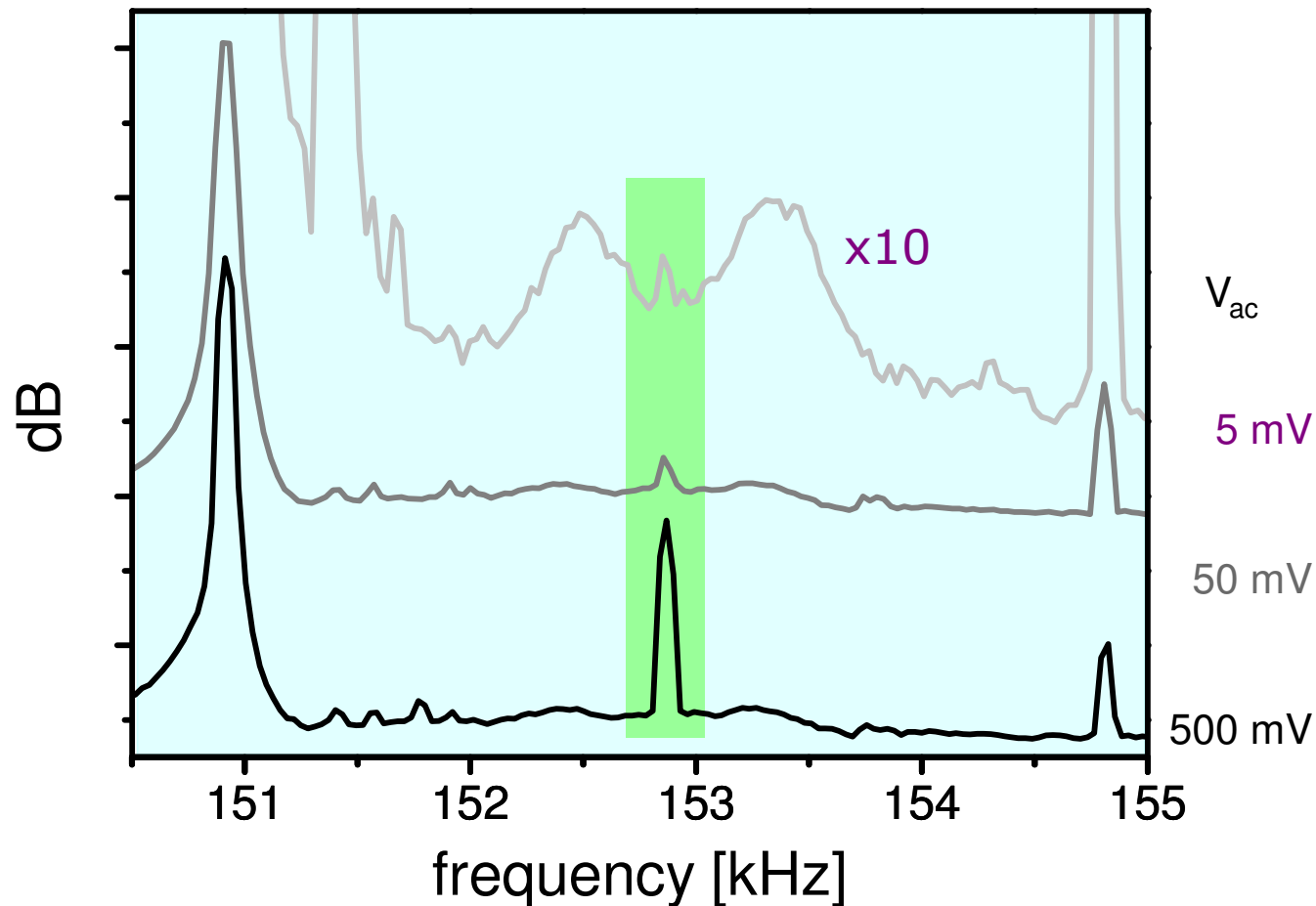

¹U.Zerweck et al., Phys. Rev. B 71, 125424 (2005)

KPFM operational modes: FM- & AM-KPFM

Frequency modulation (FM-KPFM) : $f_{mod} \sim 1$ kHz

→ f_{mod} is arbitrary but restricted to few kHz

Amplitude modulation (AM-KPFM) :

$$f_{mod} = f_1 \sim 6.3f_0$$

→ f_{mod} matches the first bending eigenmode of the cantilever above the fundamental one

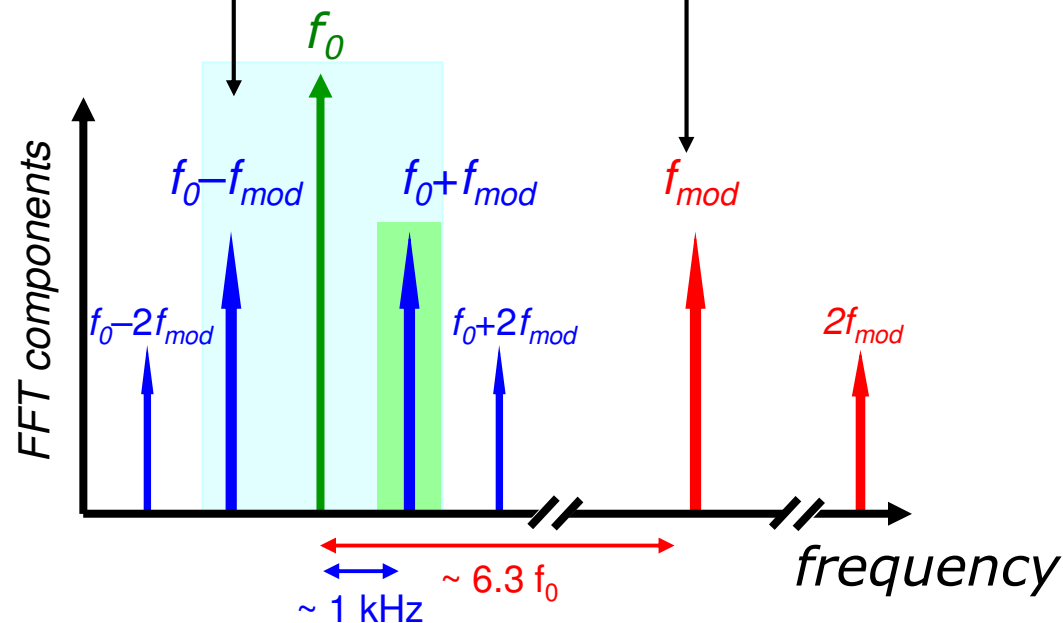

Frequency-Modulation KPFM: concept

Electrostatic force \Rightarrow shift of the resonance:

1st order :

$$f'_0 = \frac{1}{2\pi} \sqrt{\frac{k - \partial F / \partial z}{m^*}} \approx f_0 \left(1 - \frac{1}{2k} \frac{\partial F}{\partial z} \right)$$

Bias modulation (f_{mod}) \Rightarrow Electr. force modulation (f_{mod}) \Rightarrow Δf modulation (f_{mod})

FM-KPFM is sensitive to the electrostatic force gradient (?)

Frequency-Modulation KPFM: concept

Electrostatic force \Rightarrow shift of the resonance:

1st order :
$$f'_0 = \frac{1}{2\pi} \sqrt{\frac{k - \partial F / \partial z}{m^*}} \approx f_0 \left(1 - \frac{1}{2k} \frac{\partial F}{\partial z} \right)$$

Bias modulation (f_{mod}) \Rightarrow force modulation (f_{mod}) \Rightarrow Δf modulation (f_{mod})

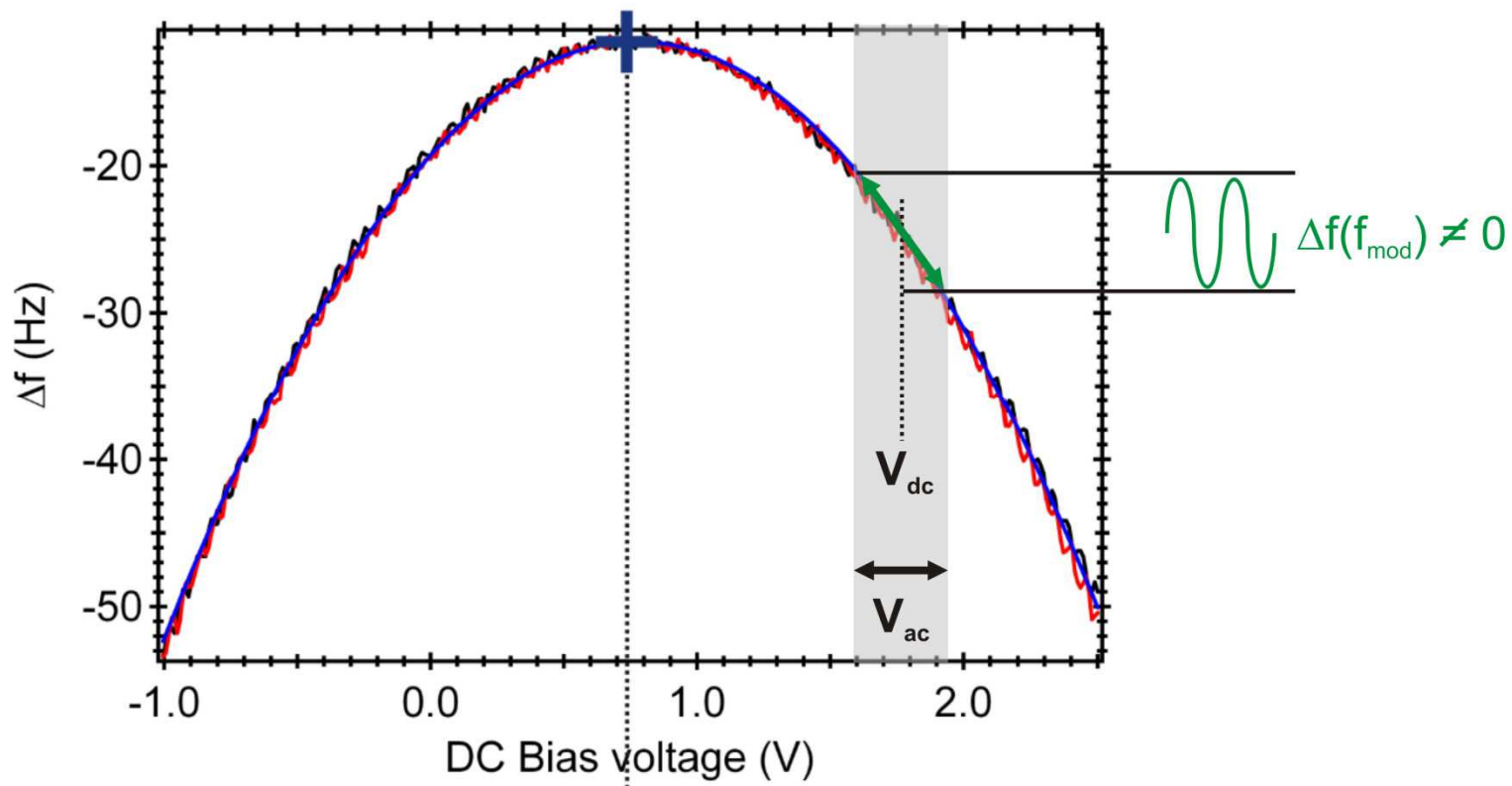

Frequency-Modulation KPFM: concept

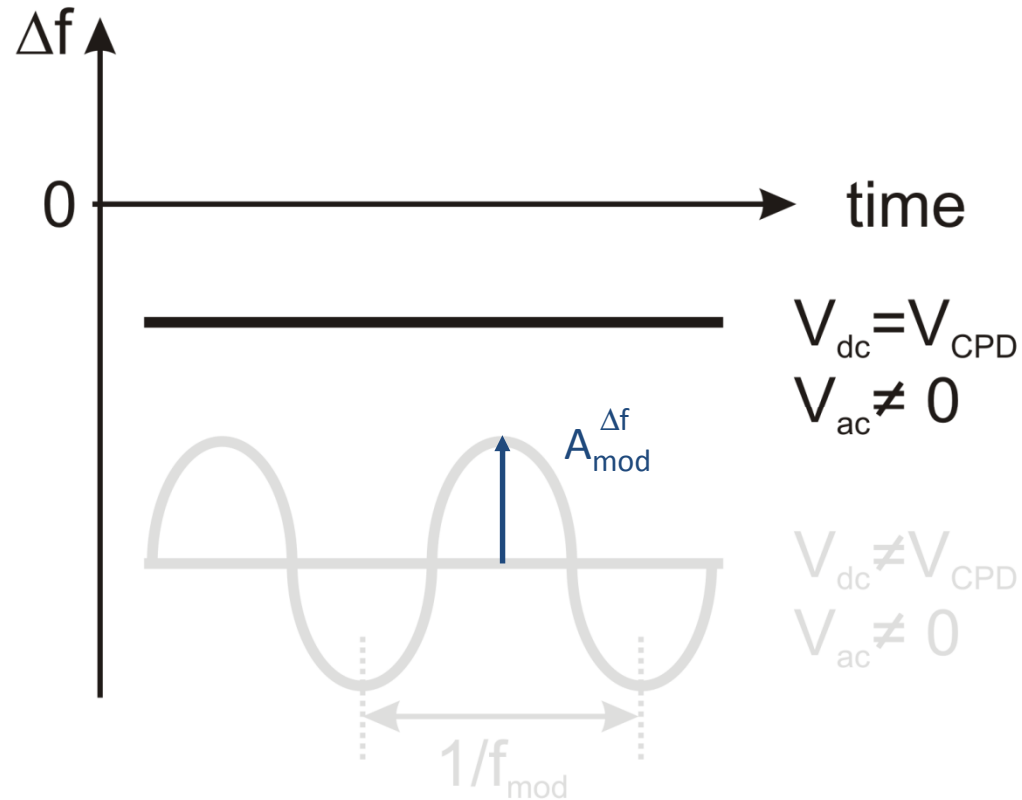

⇒ Detecting & compensating $A_{mod}^{\Delta f}$ by setting $V_{dc} = V_{CPD}$ continuously while scanning

Frequency-modulation KPFM: experimental setup

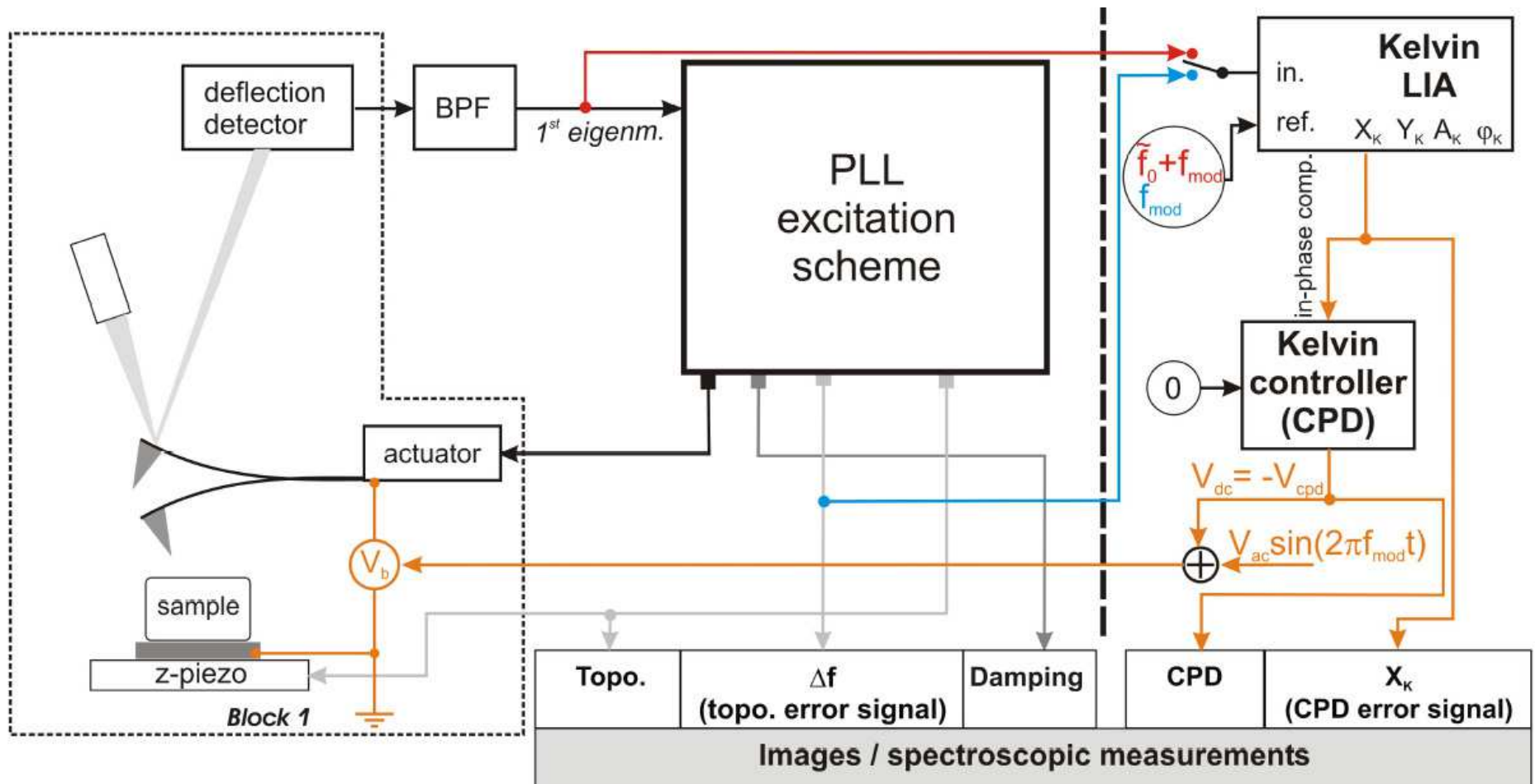

Frequency-modulation KPFM: experimental setup

- Data from Th. Glatzel (E.Meyer's group, Basel) in [1]:

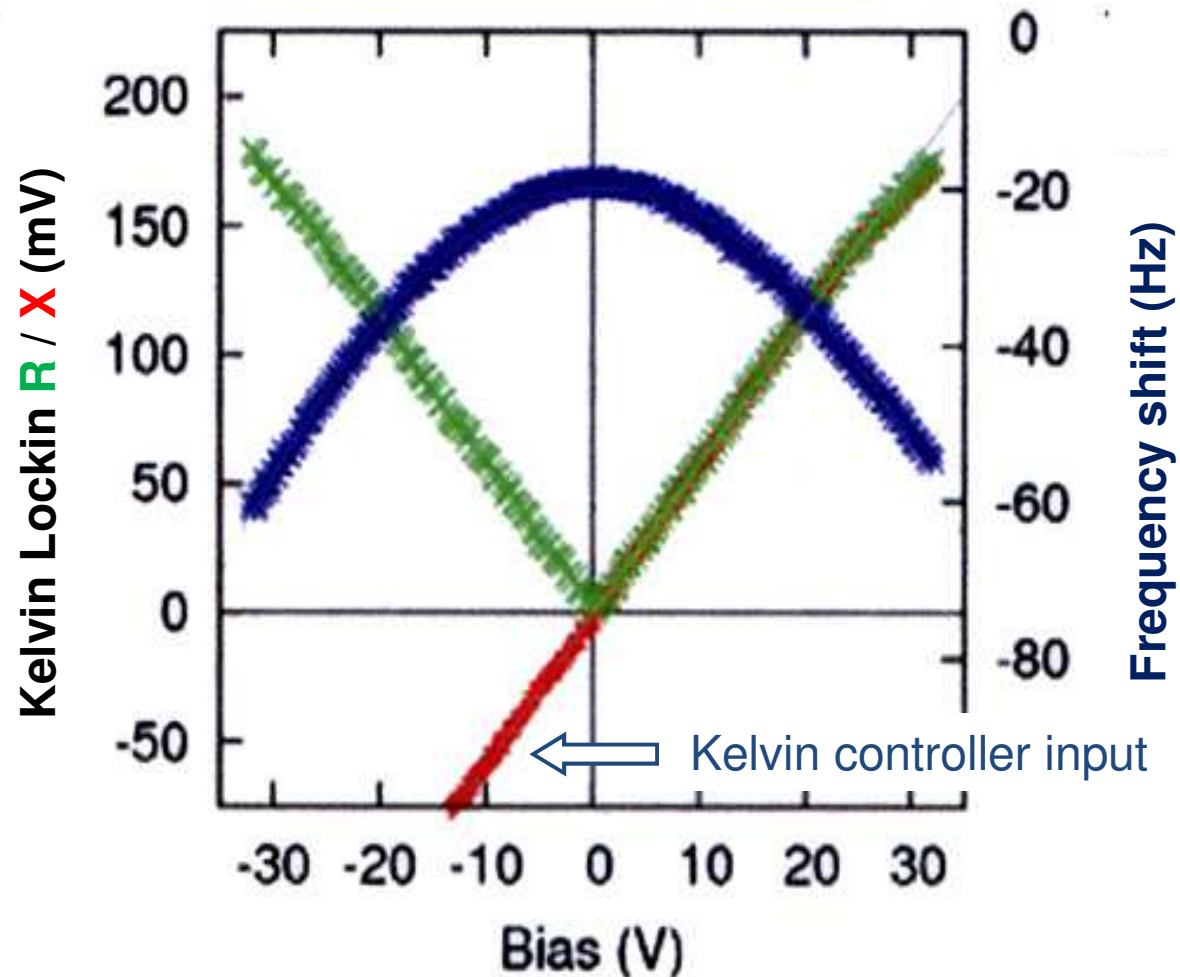

¹*Kelvin Probe Force Microscopy, Measuring & Compensating Electrostatic forces*, Springer Series in Surface Sciences (Th. Glatzel & S. Sadewasser Ed.)

Frequency-modulation KPFM: temporal considerations

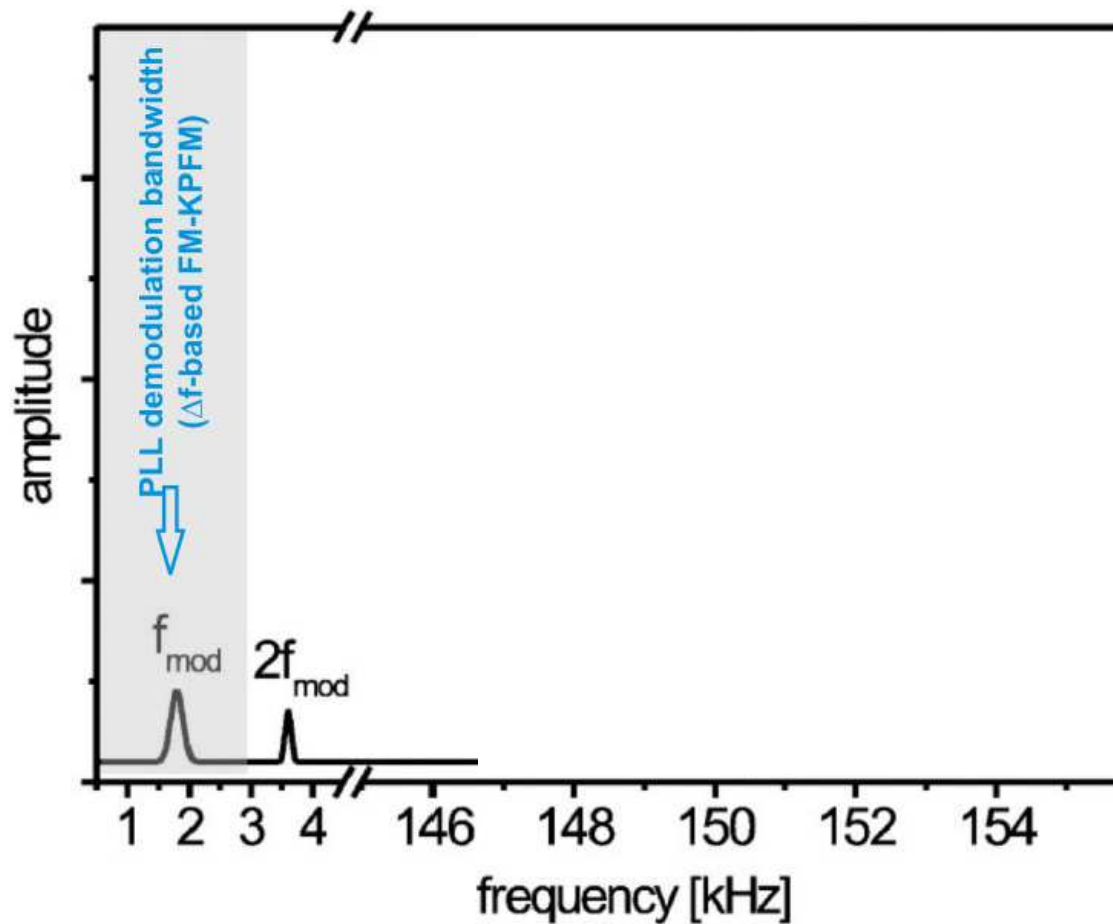

- f_{mod} has to be within the demodulation bandwidth of the PLL → compromise:
 - extending the PLL bandwidth → adds noise to Δf detection
 - must remain large enough to not influence the z regulation (usually requires to slow down the scans)
 - order of magnitude: 1 kHz

Amplitude-Modulation KPFM: concept

F_{el} is now modulated at the frequency of the first bending eigenmode of the cantilever : $f_{mod} \sim 6.3 f_0 \sim 1 \text{ MHz}$

Fundamental bending eigenmode



$f_0 \sim 150 \text{ kHz}$
 $k_0 \sim 30 \text{ N/m}$
 $Q_0 \sim 30000$ ($\Delta f_{\text{HWHM}} = 2.5$)
Mechanical actuation

AM-KPFM is sensitive to the electrostatic force (?)

First bending eigenmode

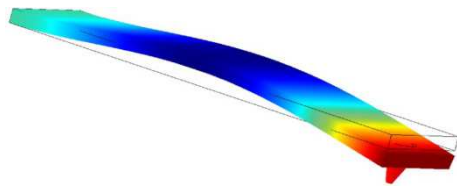

$f_1 = 6.3 f_0 \sim 1 \text{ MHz}$
 $k_1 \gg k_0$
 $Q_1 \sim 8000$ ($\Delta f_{\text{HWHM}} = 60 \text{ Hz}$)
Electrostatic actuation

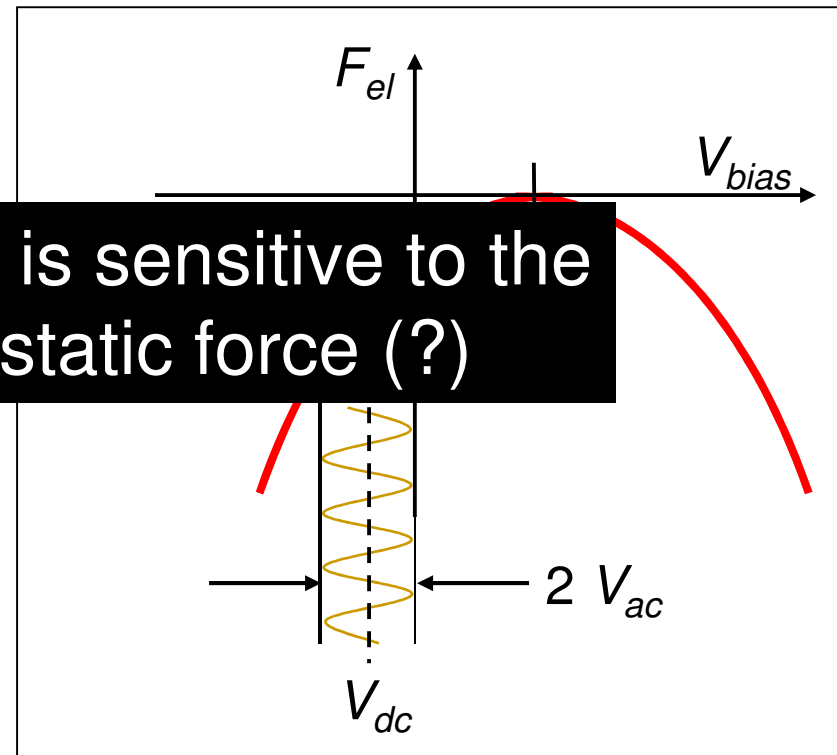

Amplitude-Modulation KPFM: concept

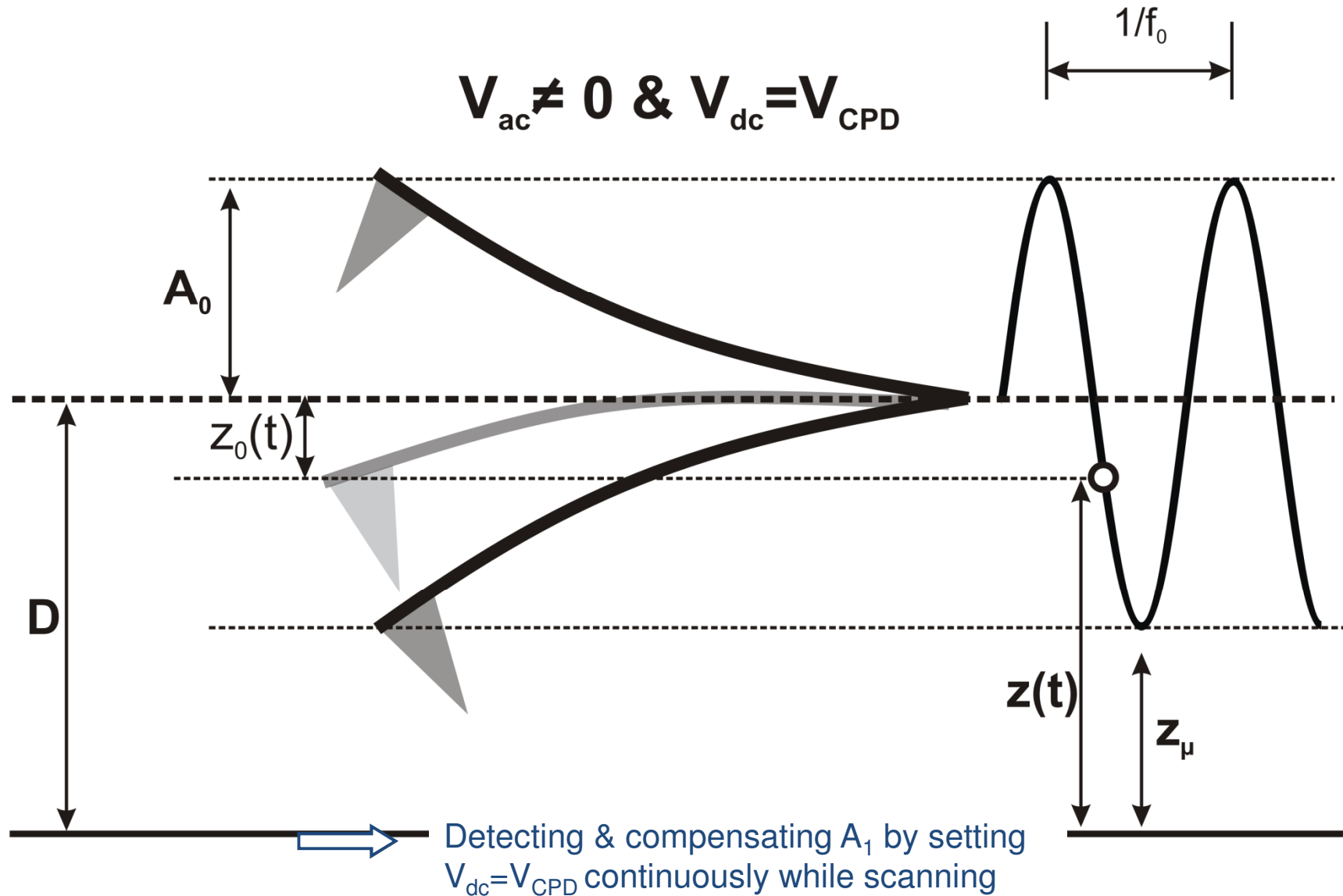

Amplitude-modulation KPFM: experimental setup

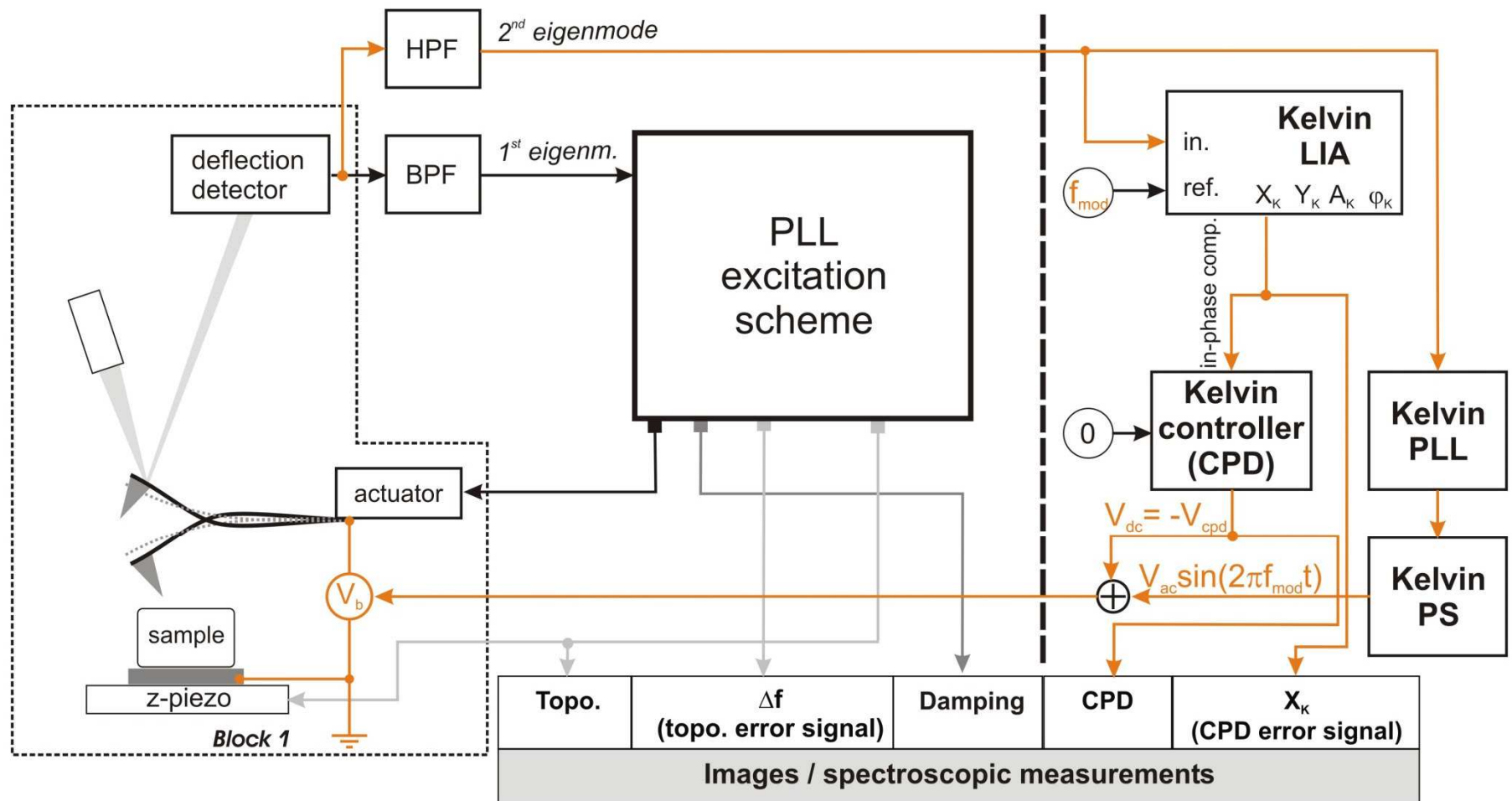

Amplitude-modulation KPFM: temporal considerations

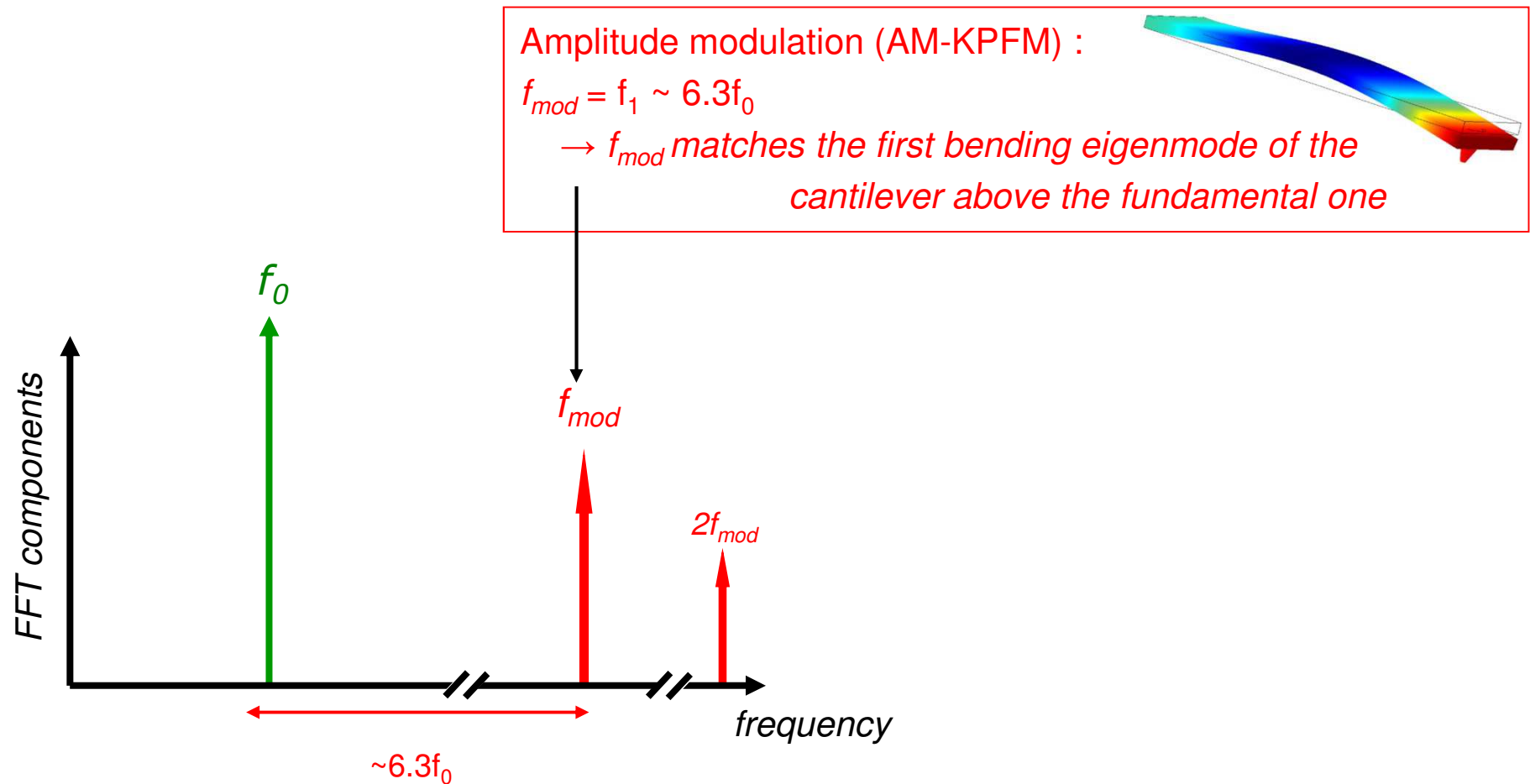

AM- vs. FM-KPFM

PHYSICAL REVIEW B 86, 075407 (2012)

Multiscale approach for simulations of Kelvin probe force microscopy with atomic resolution

Ali Sadeghi, Alexis Baratoff, S. Alireza Ghasemi, Stefan Goedecker, Thilo Glatzel, Shigeki Kawai, and Ernst Meyer

Department of Physics, University of Basel, Klingelbergstrasse 82, CH-4056 Basel, Switzerland

(Received 23 March 2012; revised manuscript received 21 June 2012; published 2 August 2012)

The distance dependence and atomic-scale contrast recently observed in nominal contact potential difference (CPD) signals simultaneously recorded by Kelvin probe force microscopy (KPFM) using noncontact atomic force microscopy (NCAFM) on defect-free surfaces of insulating as well as semiconducting samples have stimulated theoretical attempts to explain such effects. Especially in the case of insulators, it is not quite clear how the applied bias voltage affects electrostatic forces acting on the atomic scale. We attack this problem in two steps. First, the electrostatics of the macroscopic tip-cantilever-sample system is treated by a finite-difference method on an adjustable nonuniform mesh. Then the resulting electric field under the tip apex is inserted into a series of atomistic wavelet-based density functional theory (DFT) calculations. Results are shown for a realistic **neutral but reactive silicon nanoscale tip interacting with a NaCl(001) sample**. Bias-dependent forces and resulting atomic displacements are computed to within an unprecedented accuracy. **Theoretical expressions for amplitude modulation (AM) and frequency modulation (FM) KPFM signals and for the corresponding local contact potential differences (LCPD) are obtained by combining the macroscopic and atomistic contributions to the electrostatic force component generated at the voltage modulation frequency, and evaluated for several tip oscillation amplitudes A up to 10 nm. For $A = 0.1 \text{ \AA}$, the computed LCPD contrast is proportional to the slope of the atomistic force versus bias in the AM mode and to its derivative with respect to the tip-sample separation in the FM mode. Being essentially constant over a few volts, this slope is the basic quantity that determines variations of the atomic-scale LCPD contrast. Already above $A = 1 \text{ \AA}$, the LCPD contrasts in both modes exhibit almost the same spatial dependence as the slope. In the AM mode, this contrast is approximately proportional to $A^{-1/2}$, but remains much weaker than the contrast in the FM mode, which drops somewhat faster as A is increased. These trends are a consequence of the macroscopic contributions to the KPFM signal, which are stronger in the AM-mode and especially important if the sample is an insulator even at subnanometer separations where atomic-scale contrast appears.**

AM- vs. FM-KPFM

	FM-KPFM	AM-KPFM
Pros	<ul style="list-style-type: none"> • Ease of implementation • CPD contrast larger than AM- in the large amplitude regime 	<ul style="list-style-type: none"> • Better S/N ratio than FM-KPFM • More sensitive to capacitive contributions involved in high-resolution CPD imaging • CPD atomic-scale contrast reported
Cons	<ul style="list-style-type: none"> • Low bandwidth, slow, unless sidebands are used (but LIA input to be amplified) 	<ul style="list-style-type: none"> • Implementation more demanding (2nd PLL) • Large detector bandwidth required with usual cantilevers (~1 MHz)

III. Electrostatic models

1 - A charge trapped within the capacitor¹

□ Double capacitance model¹:

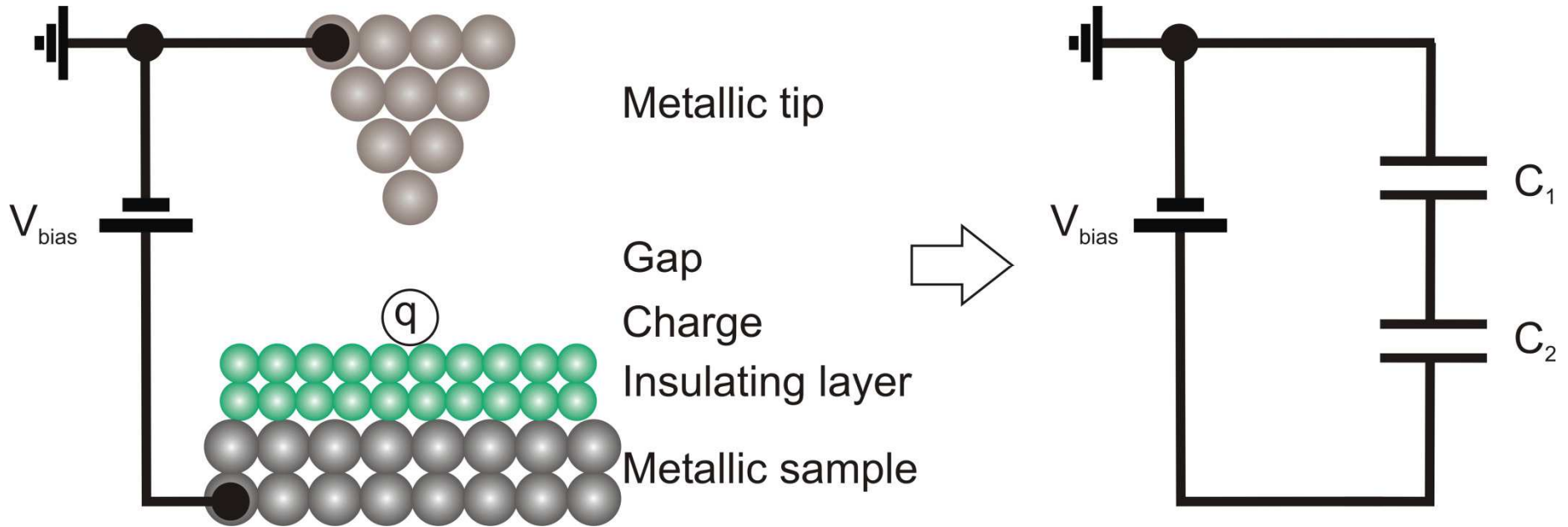

¹*Nanoelectronics and Information Technology: Advanced Electronic Materials and Novel Devices*, edited by R. Waser (John Wiley & Sons, New York, 2003); R. Stomp et al., *Phys. Rev. Lett.* 94 , 056802 (2005); J. Polesel et al., *Nanotechnology* 15, S24 (2004)

1 - A charge trapped within the capacitor¹

□ Superposition principle:

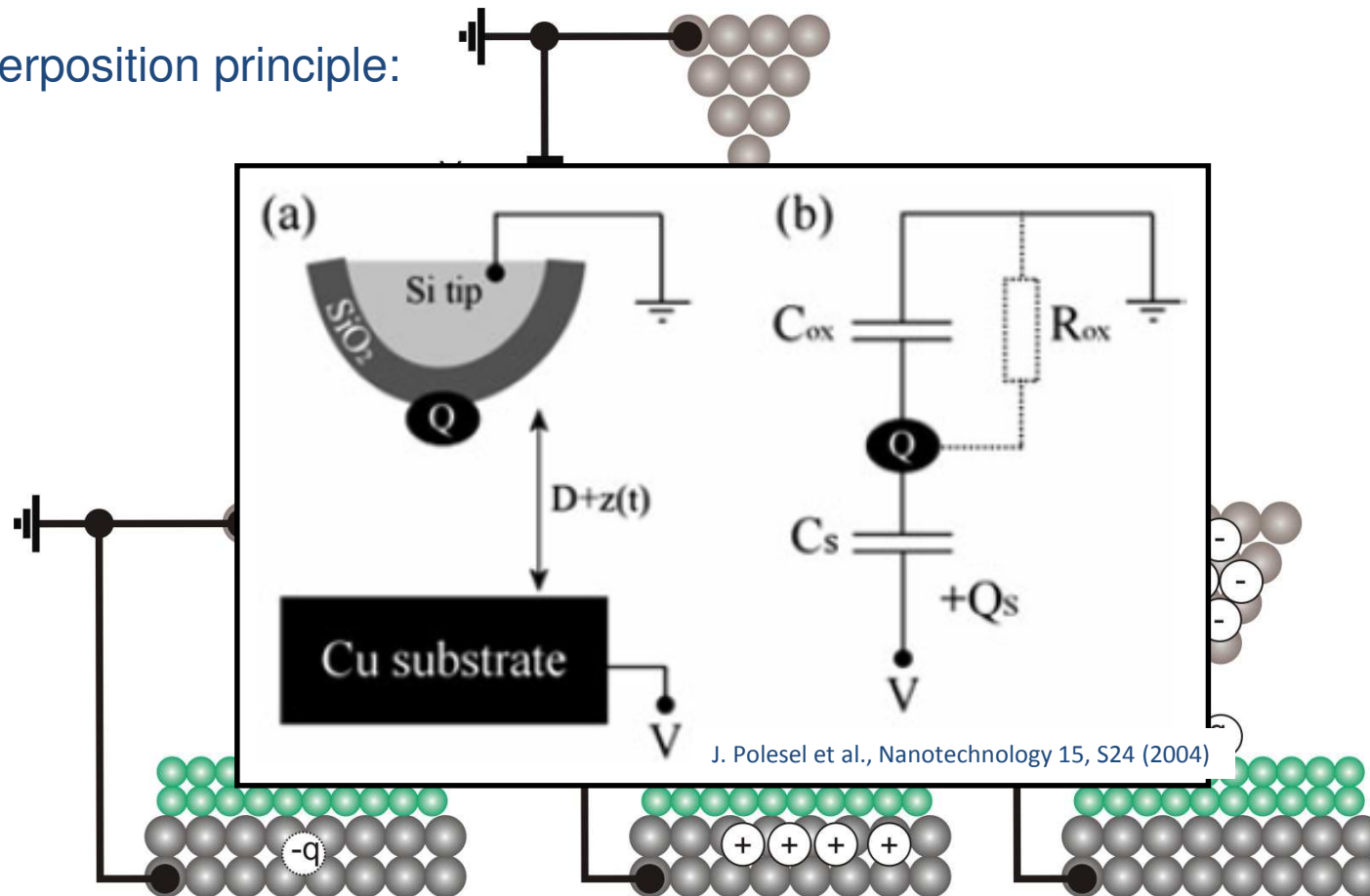

$$F^{el} = \frac{1}{C_{\Sigma}^2} \frac{\partial C_1}{\partial z} \left(\frac{q^2}{2} + \frac{1}{2} C_2^2 V_{bias}^2 - C_2 q V_{bias} \right)$$

What about polarisability ?!?

1 - A charge trapped within the capacitor¹

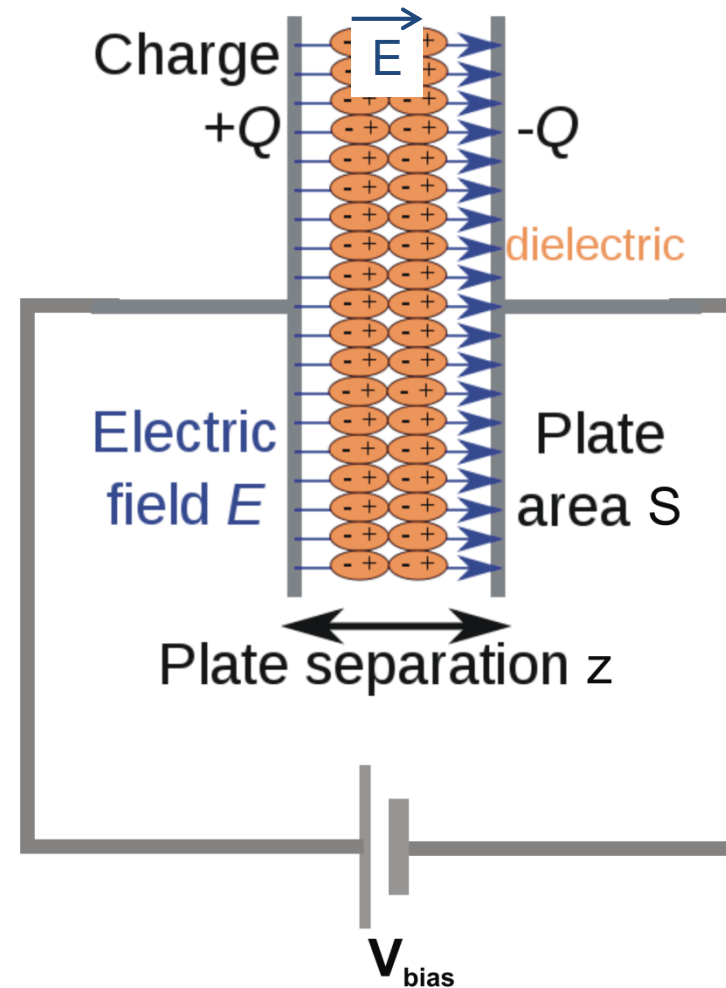

polarizability

□ Dipole moment of each part of dielectric within the capacitance:

$$\vec{p} = \alpha \epsilon_0 \vec{E}$$

2 - An assembly of charges trapped within the capacitor¹

Interaction force : $F(z) = F_{lr}(z) + F_{es}(z) + F_{sr}(z)$ with $F_{es} = \int_{\text{tip}} \frac{\sigma^2}{2\epsilon_0} \hat{n} \cdot \hat{u}_z dS$

Building the analytic approach to F_{es} :

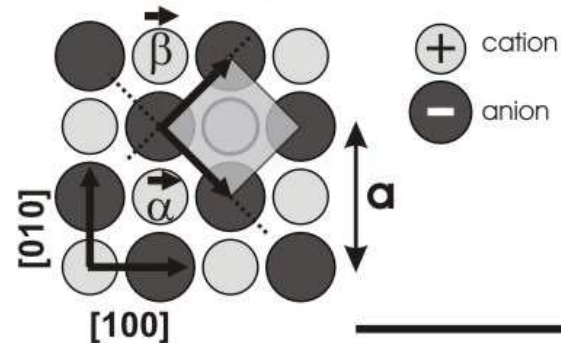

- ✓ Crystal surface has a perfect fcc structure, carrying **neither local charge nor dipole**
- ✓ The **Madelung potential expands at the surface²**, although decaying exponentially fast

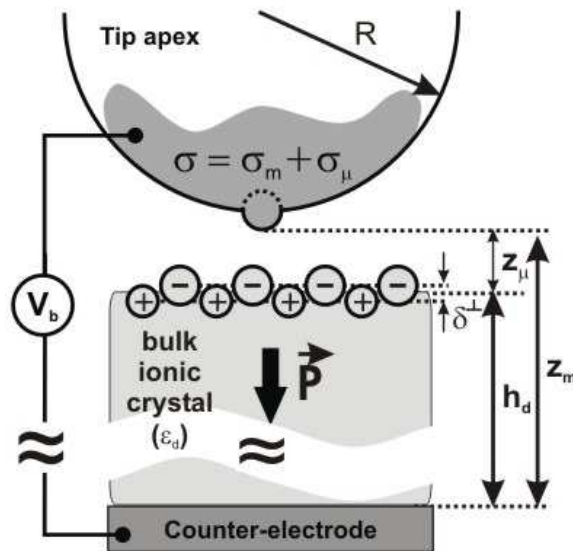

- ✓ **Tip apex**: microscopic structure (nano-asperity, area 1, radius R_a) + mesoscopic half-sphere (area 2, radius R): **METALLIC**
- ✓ **Sample**: topmost infinite layer of alternate point charges + bulk treated as a continuous medium
- ✓ Surface charge density that develops on the tip has 2 origins:
 - ☞ **capacitive contribution (mesoscopic): σ_m , connected with V_b**
 - ☞ **Madelung surface potential-mediated contribution (microsc.): σ_μ**
- ✓ **Description of the ionic polarization of the sample , self-consistency**
- ✓ Classical approach

¹ F. Bocquet *et al.*, Phys. Rev. B **78**, 035410 (2008); ² R. Watson *et al.*, Phys. Rev. B **24**, 1791 (1981)

2 - An assembly of charges trapped within the capacitor

Superposition principle :

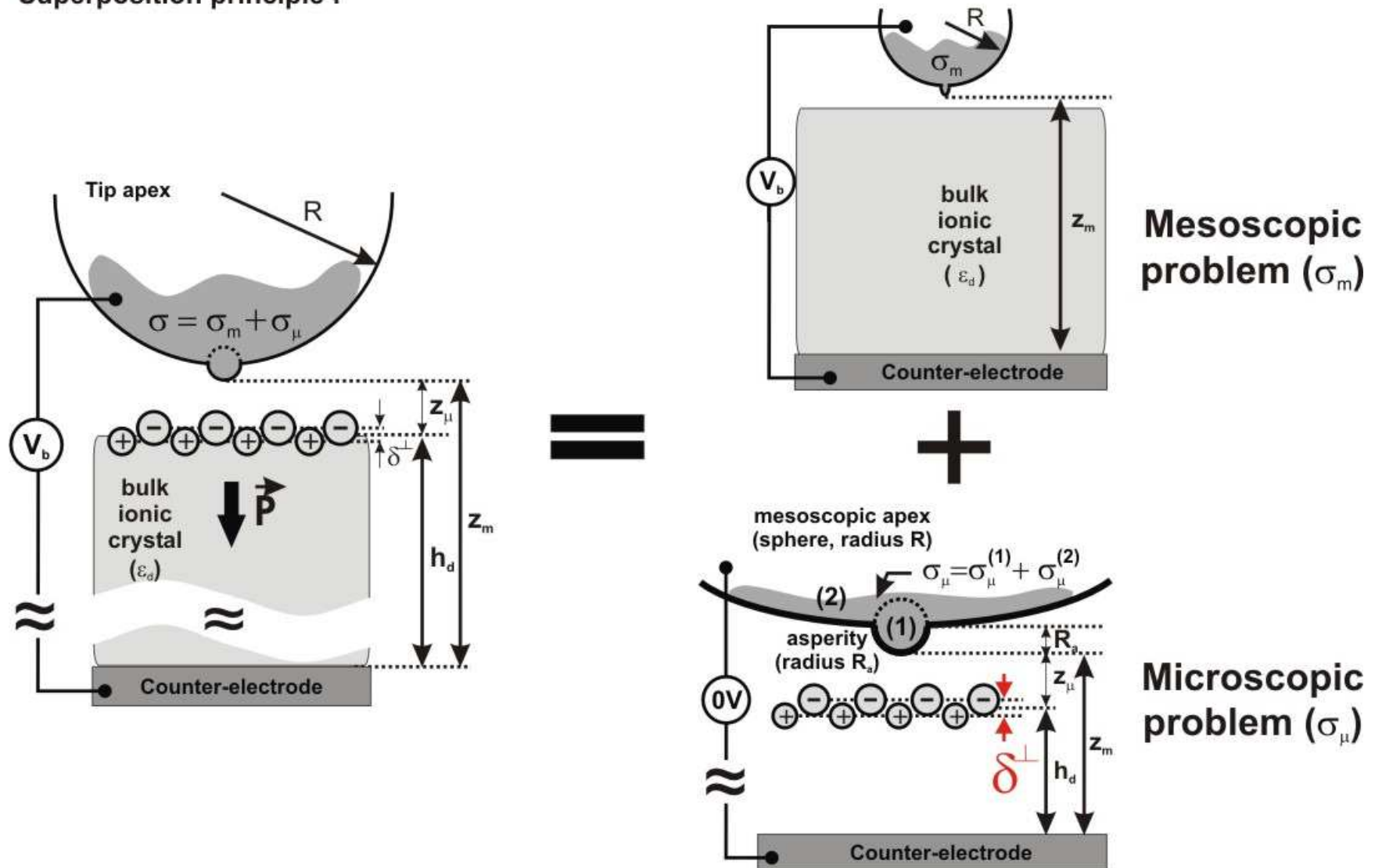

2 - An assembly of charges trapped within the capacitor

Madelung surface potential¹:

$$V_s(x, y, z, \mu) = - \frac{q}{\pi \epsilon_0 a'} \cosh \left[\tilde{\delta}^\perp (V_b) \tilde{\chi}(x, y) e^{-(2\pi/a')z, \mu} \right]$$

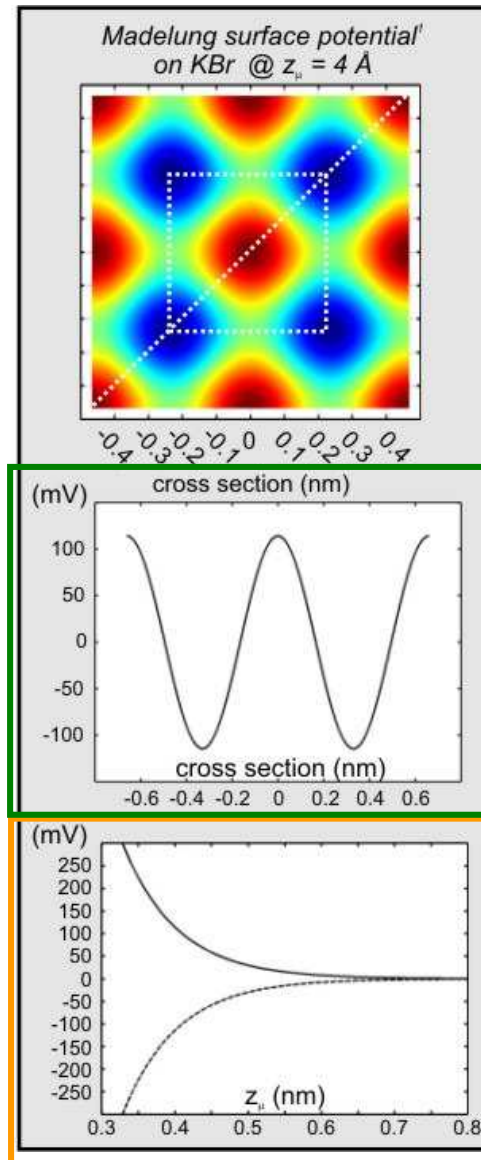

¹ R. Watson *et al.*, Phys. Rev. B **24**, 1791 (1981)

2 - An assembly of charges trapped within the capacitor

$$F_{es} = \int_{\text{tip}} \frac{(\sigma_m + \sigma_\mu)^2}{2\epsilon_0} \hat{n} \cdot \hat{u}_z dS = \cancel{F_m} + F_{m\mu} + F_\mu$$

• F_m : negligible (counter-electrode too far)

- short-range
- Lateral periodicity of the MSP
- Proportional to V_b

- short-range
- V_b^2 dependence (rec)
- No lateral periodicity

2 - An assembly of charges trapped within the capacitor

$$F_{es} = \int_{\text{tip}} \frac{(\sigma_m + \sigma_\mu)^2}{2\epsilon_0} \hat{n} \cdot \hat{u}_z dS = F_m + F_{m\mu} + F_\mu$$

- ☞ F_m : negligible (counter-electrode too far)
- ☞ $F_{m\mu}^{(2)}$: capacitive coupling on the mesoscopic part of the tip decays fast; negligible compared to $F_{m\mu}^{(1)}$; tip enhancement effect
- ☞ $F_\mu^{(1)}$: negligible compared to $F_\mu^{(2)}$ (not obvious, geometry dependent)

$$F_{es} = F_{m\mu}^{(1)} + F_\mu^{(2)}$$

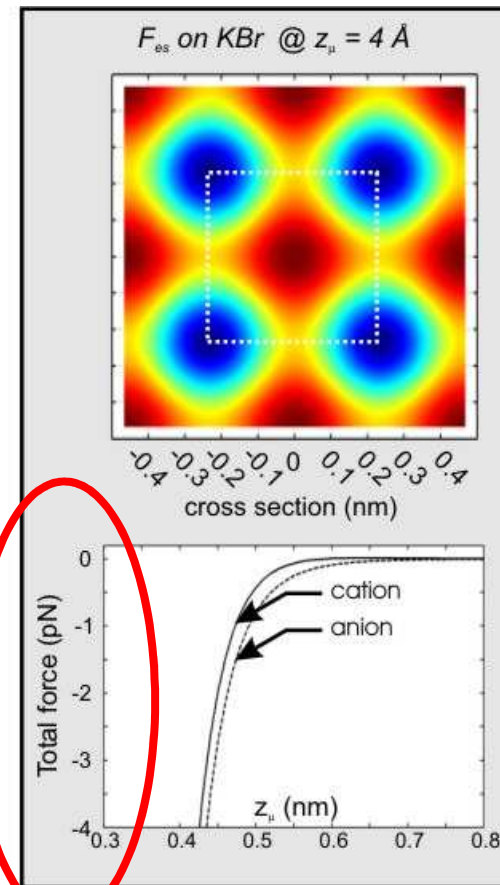

$$F_{es}(V_b) = B \times V_b \exp \left\{ -\frac{2\pi}{a'} z_\mu \right\} \times [\cos(\tilde{x}_0) + \cos(\tilde{y}_0)] + (AV_b^2 + C) \times \exp \left\{ -\frac{4\pi}{a'} z_\mu \right\}$$

with $V_b = V_{dc} + V_{ac} \sin(2\pi f_K t)$

**short-range
electrostatic
force**

Summary

In general, the electrostatic has the form:

$$F^{\text{el}} = AV_{\text{bias}}^2 + BV_{\text{bias}} + C$$

Hence, the f_{mod} -modulated component has the form:

$$F^{\text{el}, f_{\text{mod}}} = [B + 2A(V_{\text{dc}} - V_{\text{CPD}})] V_{\text{ac}} \sin(2\pi f_{\text{mod}} t)$$

Therefore:

$$V_{\text{dc}} = V_{\text{CPD}} - \frac{B}{2A}$$

- The measured « CPD » conceals the physics of the interface (parameters A & B): capacitance, charges, dipoles...
- B and A may be **tip geometry and distance dependent...**

Summary

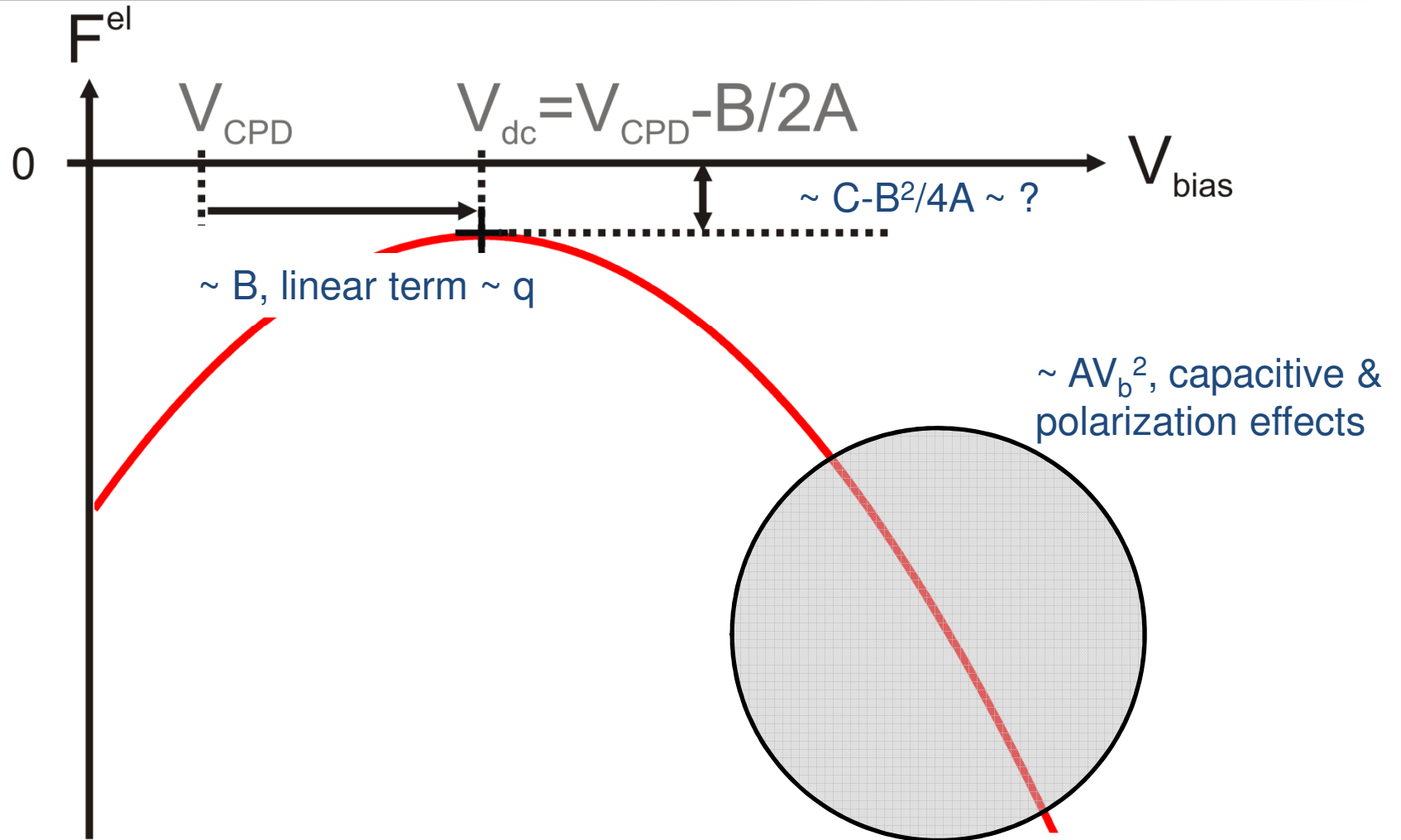

IV. Applications

KPFM on metallic surfaces including adsorbates:

□ Thin insulating films :

KCl on Au(111)¹ (FM-KPFM):

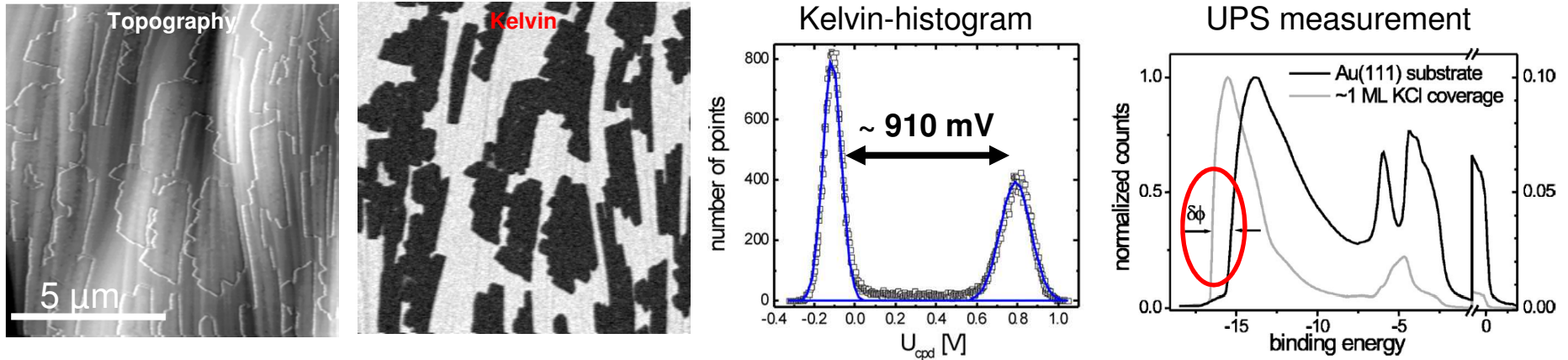

- KCl islands decrease the CPD: interface dipole decreased (c.t. to the sample)
- **Quantitative measurement of the CPD when adsorbates are larger than the tip radius**
 - result confirmed in the literature (see “References” section)

¹U. Zerweck *et al.*, Phys. Rev. B **71**, 125424 (2005);

KPFM on metallic surfaces including adsorbates:

□ Thin insulating films :

Ionic thin films on Au(111)¹ (FM-KPFM):

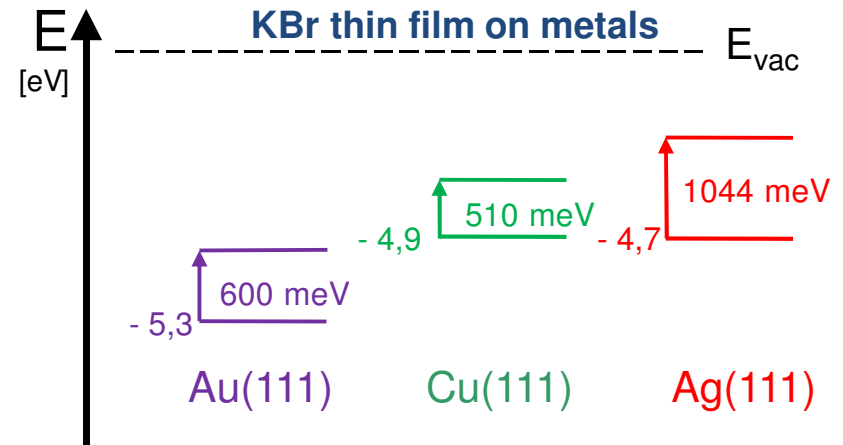
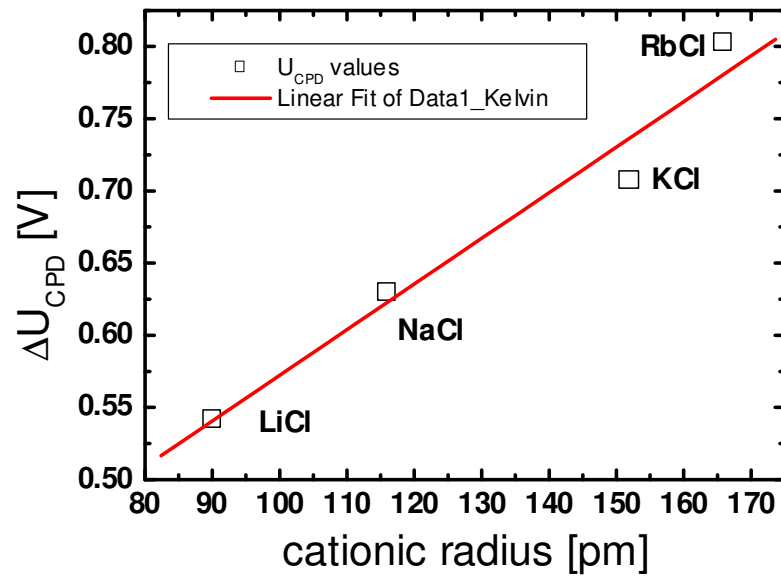

- Interface dipole varies with the nature of the metal
- Adsorption properties must change

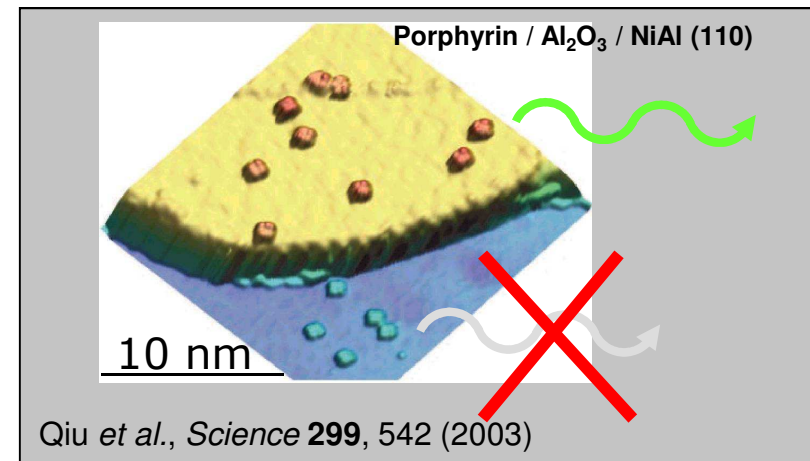

¹Ch. Loppacher *et al.*, *Nanotechnology* **15**, S9 (2004)

KPFM on metallic surfaces including adsorbates:

□ Molecular films :

CuPc on Au(111)¹ (FM-KPFM):

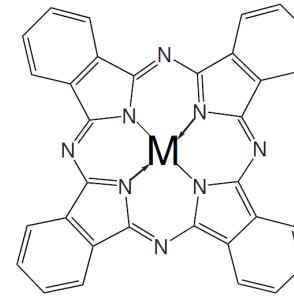
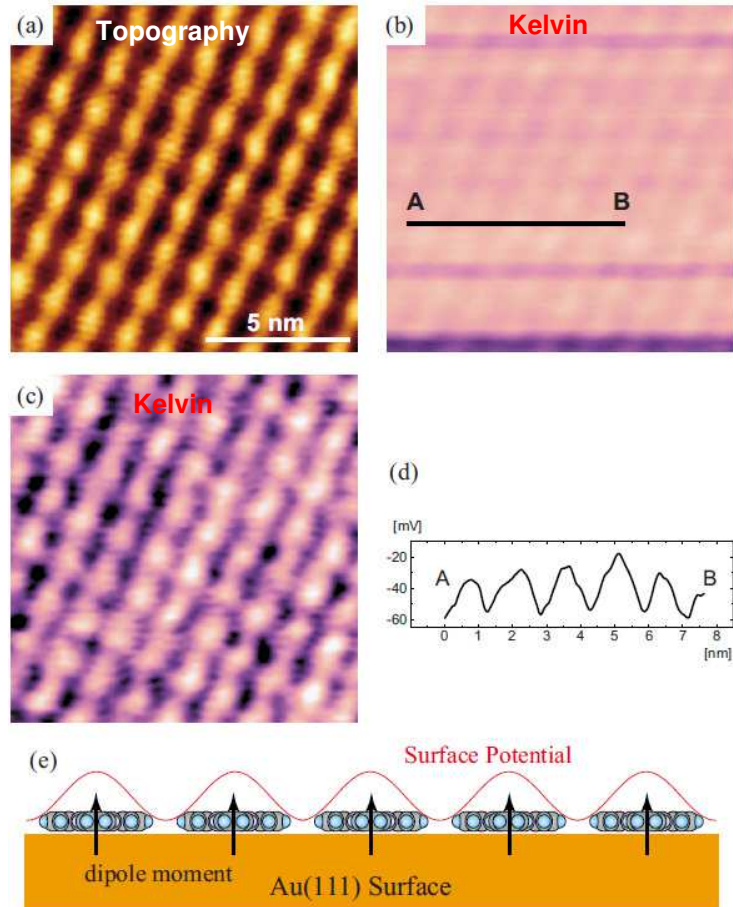

M=Cu, Co

- Molecular resolution in KPFM
- +30mV positive shift, increase of the interface dipole, c.t. to the layer
- Results interpreted in terms of electrostatic MS interaction

¹T. Ichii *et al.*, JAP **107** 024315 (2010);

KPFM on metallic surfaces including adsorbates:

□ Molecular films :

C_{60} on Ag(111)¹ (FM-KPFM):

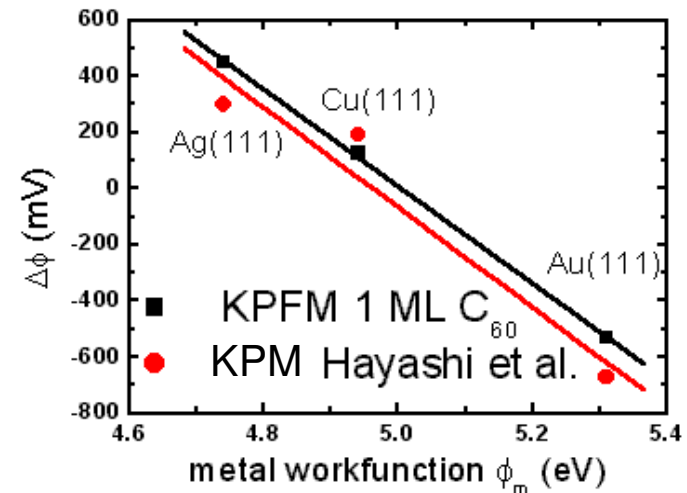
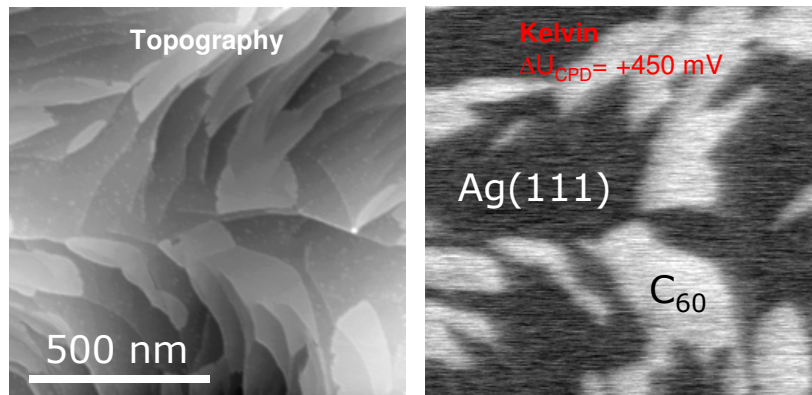

- C_{60} layers increase the CPD: interface dipole increase, c.t. to the molecules
- Behavior which depends on the nature of the metal
- Results compliant with macroscopic KPM

¹U. Zerweck *et al.*, Nanotechnology **18** 084006 (07); Hayashi *et al.*, JAP **92**, 3784 (02)

KPFM on bulk insulators

□ Mixed ionic crystals¹: NaCl(001)+1% KCl (FM-KPFM)

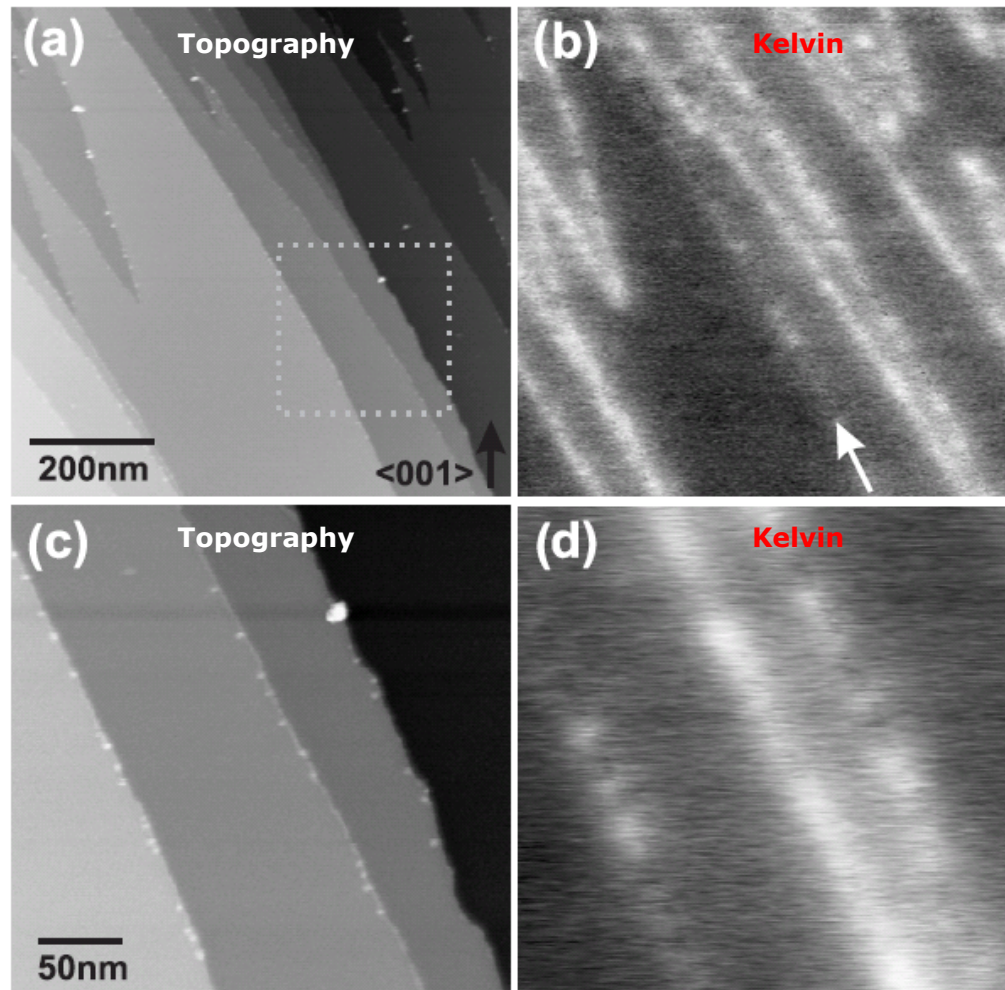

- Significant positive CPD shift at the step edges (+300 mV)
- Local (-) charges are heterogeneously trapped along the step edges : not intrinsic
- Similar behavior on other alkali halides (KCl)

Origin of these charges?

¹C. Barth *et al.*, *Nanotechnology* **17**, S155 (2006)

KPFM on bulk insulators

□ $\text{KCl}(001)$ ¹: (FM-KPFM)

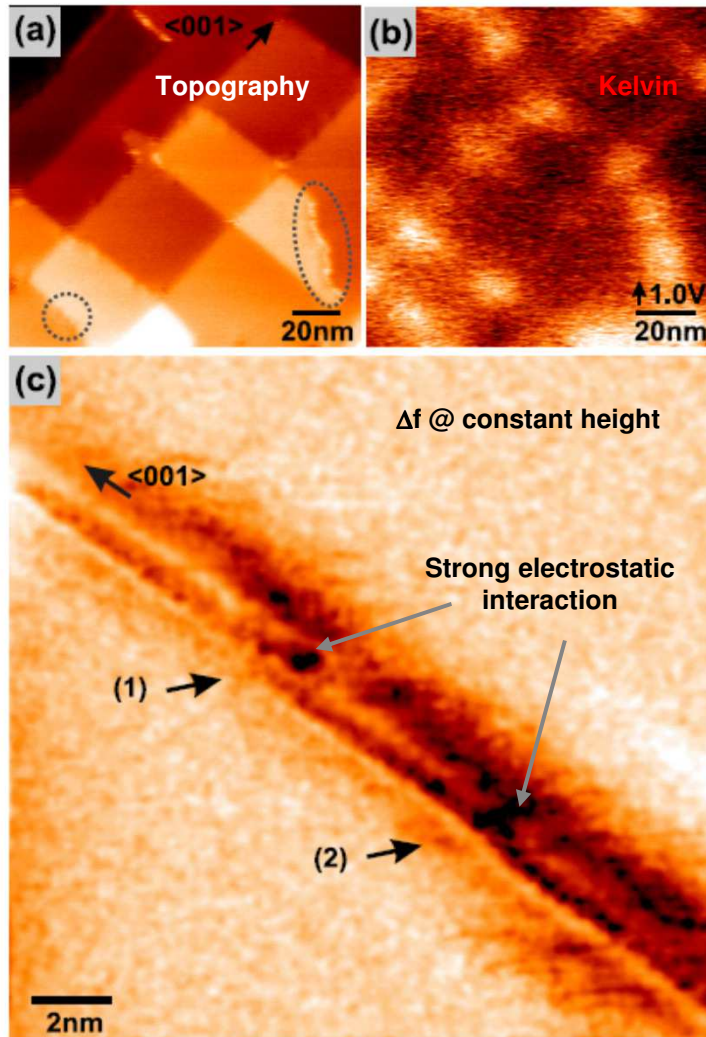

“Double layer surface“ effect²

- Ionic crystals are extrinsic : Ca^{2+} impurities nearby steps below the surface
- Global charge of the crystal is neutral $\rightarrow V^-$ centers (cationic vacancies)
- Net negative charge nearby (below) step edges and kink sites

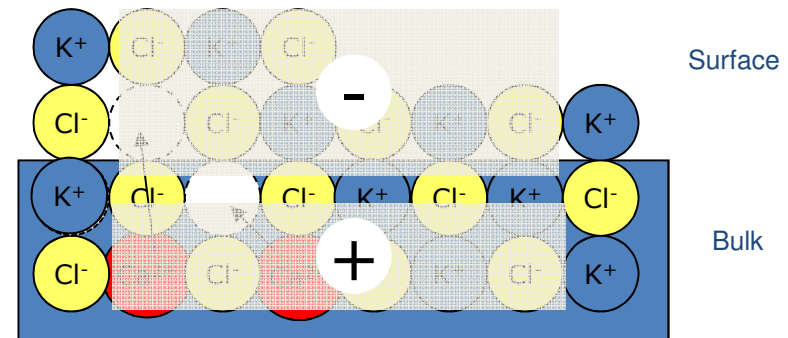

¹C. Barth *et al.*, *Phys. Rev. Lett.* 98, 136804 (2007); ²J. Frenkel, *Kinetic Theory of Liquids*, (Clarendon Press, Oxford, 1946).

KPFM on bulk insulators including molecular films

□ CyanoPorphyrin on KBr(001) +Au¹: (AM-KPFM)

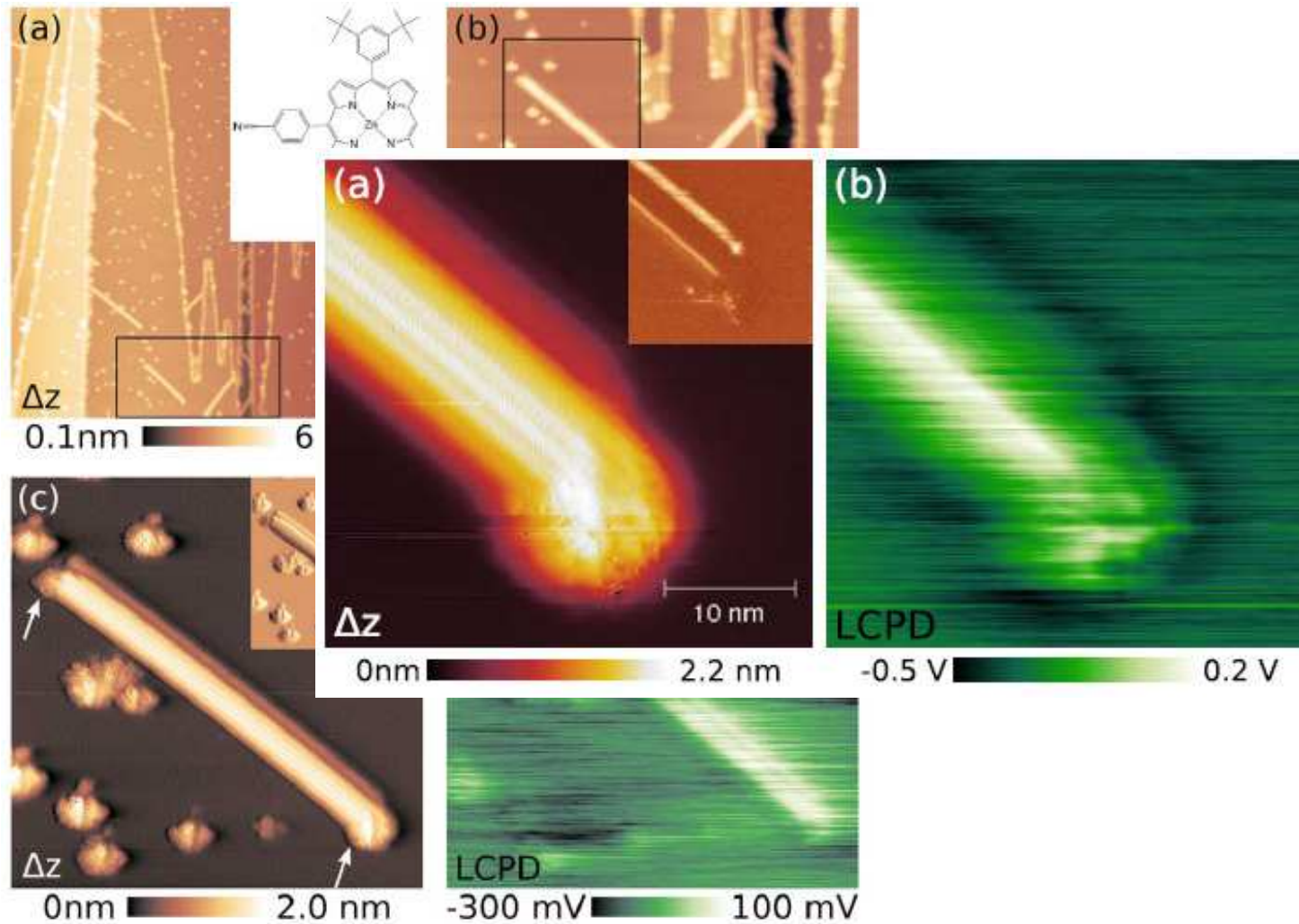

¹T. Glatzel *et al.*, *Nanotechnology* **17**, S155 (2006)

V. High-resolution KPFM

Surface dipole & work function in metals

K. Wandelt, *Appl. Surf. Sci.* 111, 1 (1997)

"The work function φ of an **infinite homogeneous metal** surface is defined as the energy difference between... the Fermi level... and a final state... the so called vacuum level."

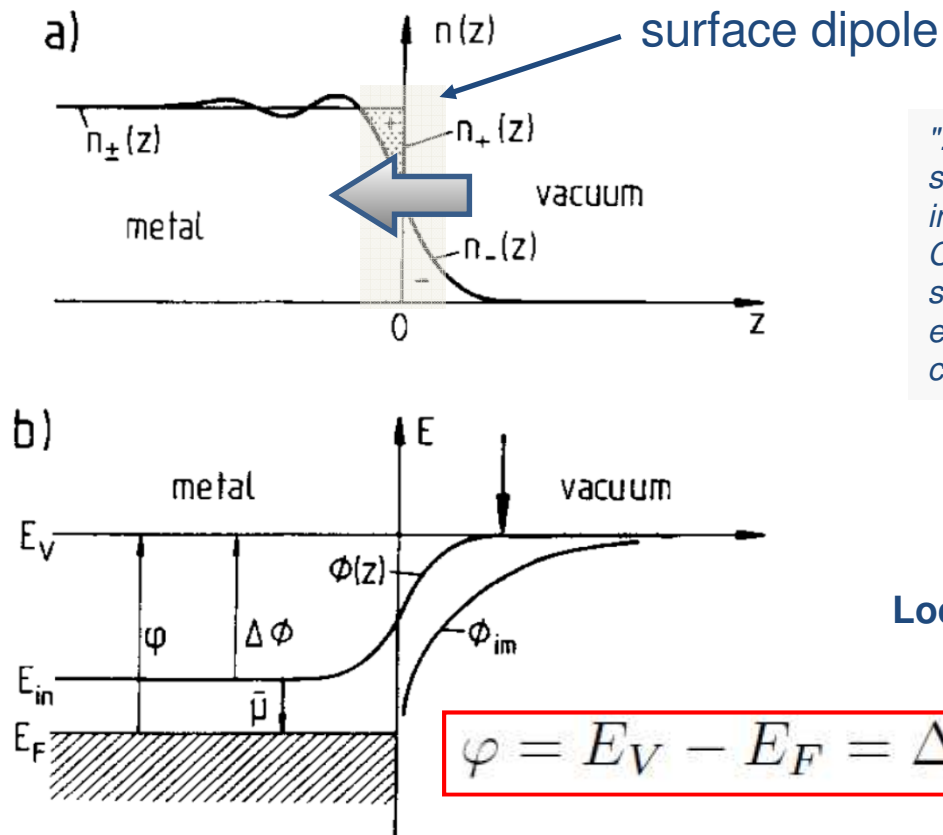

"...**Real (metallic) surfaces** are (a) of limited size, (b) made up by discrete atoms, (c) mostly include chemical and structural defects... Consequently $\Phi(z)$... vary parallel to the surface. A few Å away from the surface, the energy difference $\varphi_{loc} = \Delta\Phi(x,y,z) - \mu$ acquires the character of a **local work function**"

KPFM

**Local Contact Potential Difference (LCPD)
= Short-Range Electrostatic forces**

High-resolution KPFM: semiconductor surfaces

- S. Kitamura *et al.*, Appl. Surf. Sci. **157**, 222 (2000) : Au/Si(111) 7x7

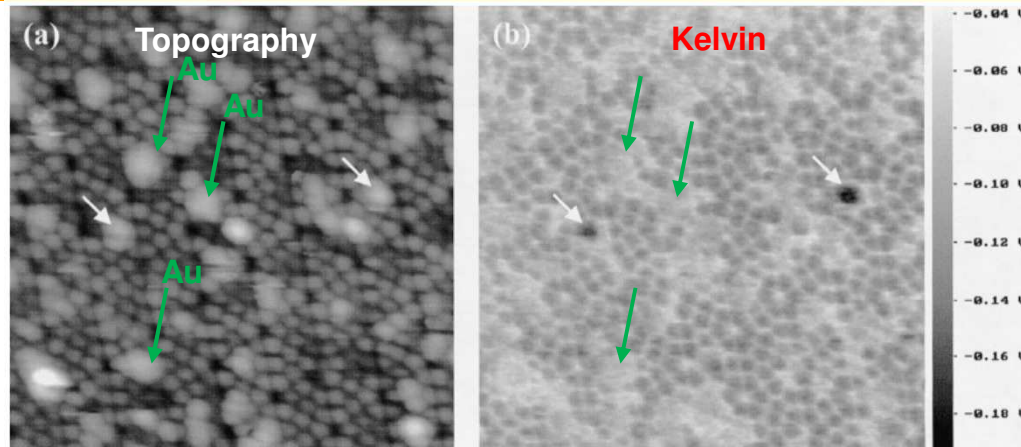

"The potential difference of atomic structures...**does not seem to reflect the work function** as we initially expected. It is therefore considered that the atomic potential difference reflects the local electron density on the surface."

- K. Okamoto *et al.*, Appl. Surf. Sci. **210**, 128 (2003) : Si(111)5√3x5√3-Sb

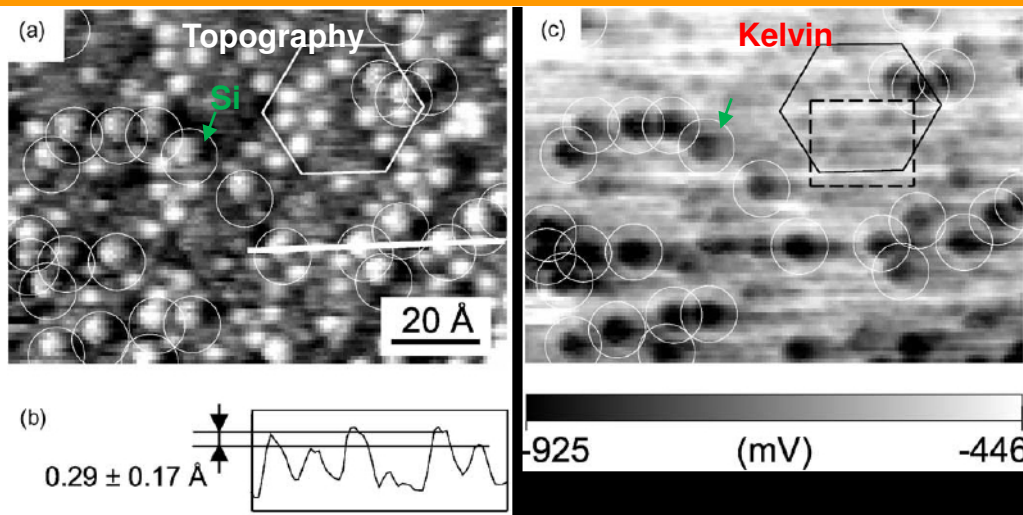

First attempt to identify species of individual atoms by KPFM

Potential of adatoms (surface potential) : $V_{\text{Si}} \sim V_{\text{Sb}} - 0.2\text{V}$
 : "This value disagrees with the theoretical work functions of Si and Sb in bulk state...Our result indicates that KPFM on atomic scale does not measure the energy of the HOMO level."

High-resolution KPFM: bulk insulators

- KBr(001)¹: T.Glatzel (Basel, AM-KPFM)

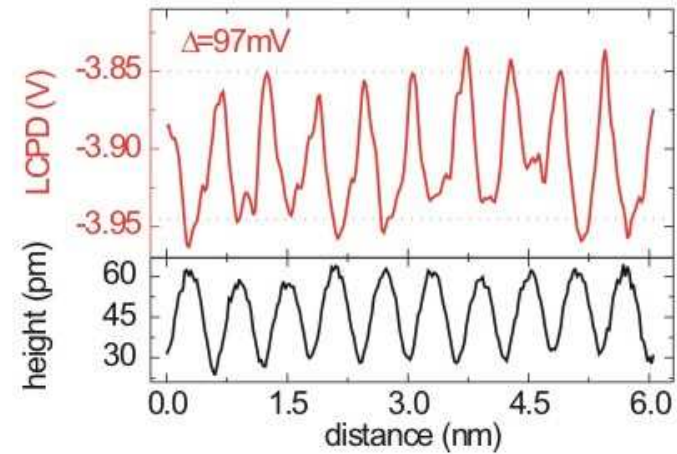
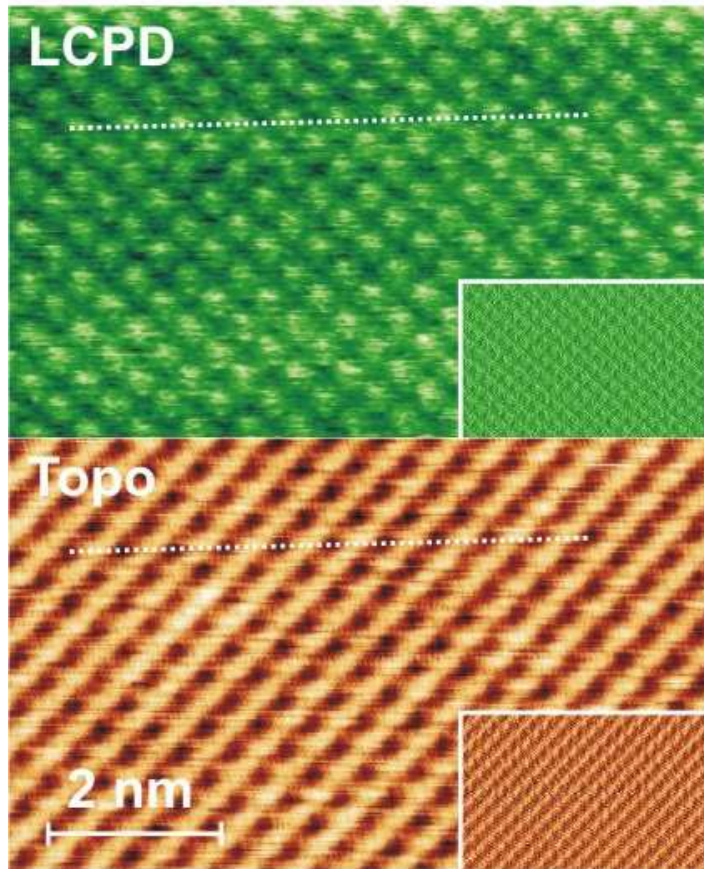

¹F.Bocquet et al., Phys. Rev. B **78**, 035410 (2008);

High-resolution KPFM: charge state of individual atoms

Measuring the Charge State of an Adatom with Noncontact Atomic Force Microscopy

Leo Gross,^{1*} Fabian Mohn,¹ Peter Liljeroth,^{1,2} Jascha Repp,^{1,3} Franz J. Giessibl,³ Gerhard Meyer¹
 12 JUNE 2009 VOL 324 SCIENCE

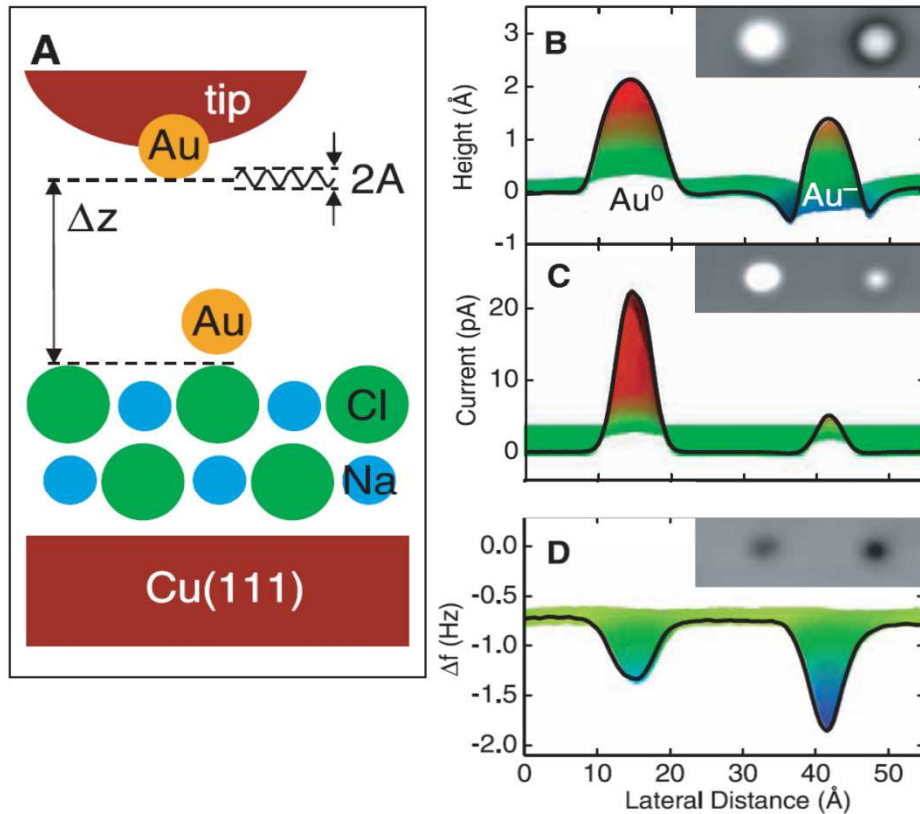

Topographic sensitivity to the charge state on the atomic scale

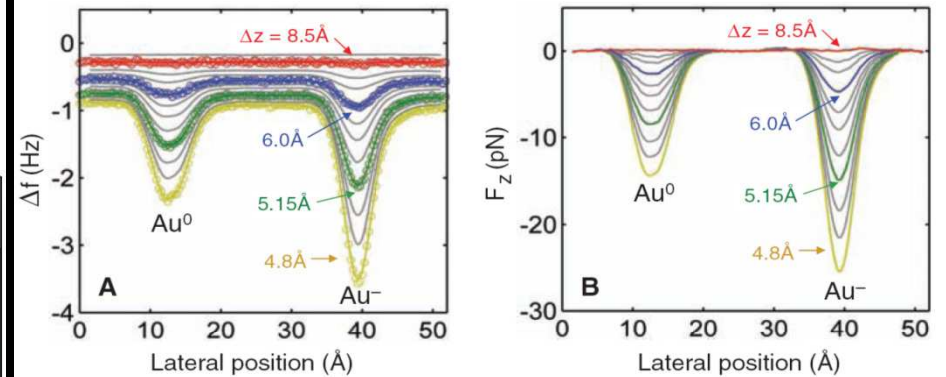

Spectroscopic sensitivity to the charge state on the atomic scale

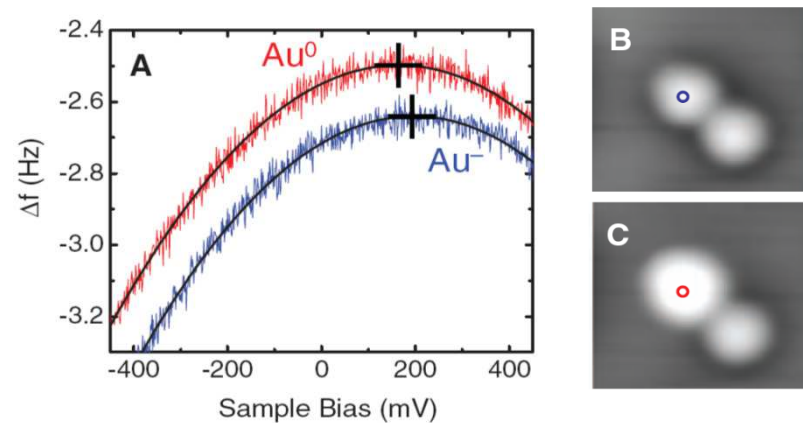

High-resolution KPFM: intramolecular resolution

nature
nanotechnology

LETTERS

PUBLISHED ONLINE: 26 FEBRUARY 2012 | DOI: 10.1038/NNANO.2012.20

Imaging the charge distribution within a single molecule

Fabian Mohn*, Leo Gross, Nikolaj Moll and Gerhard Meyer

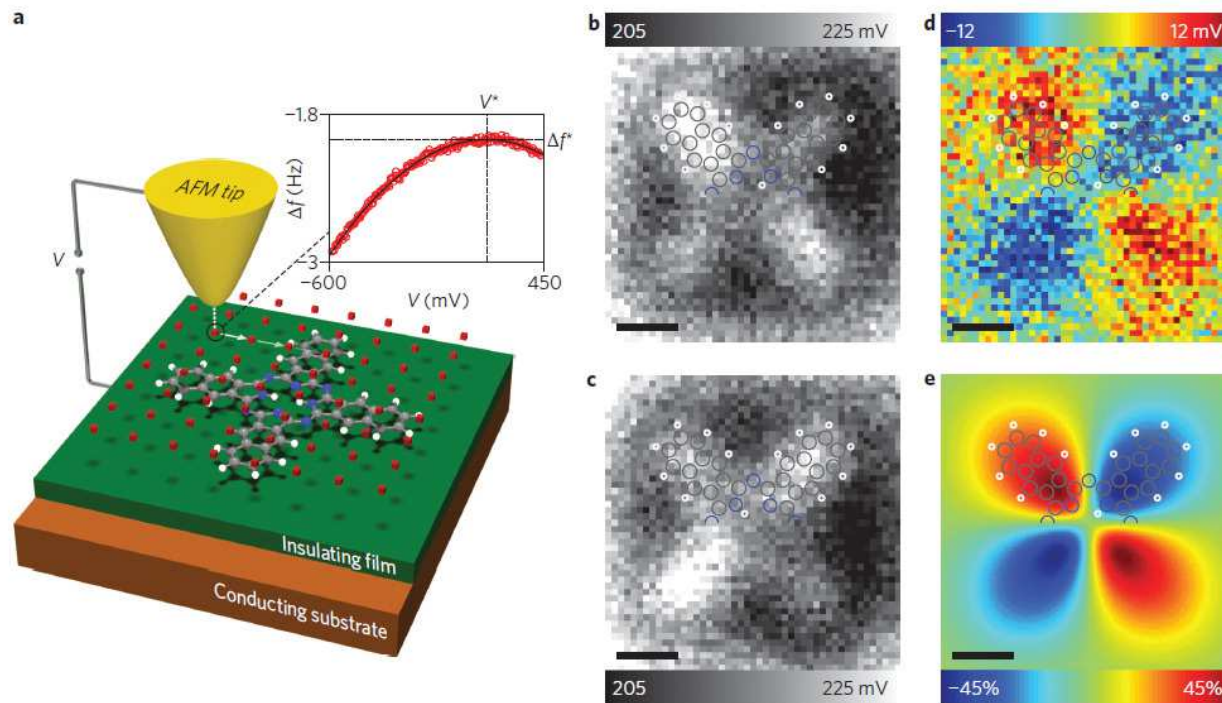

High-resolution KPFM: modelling

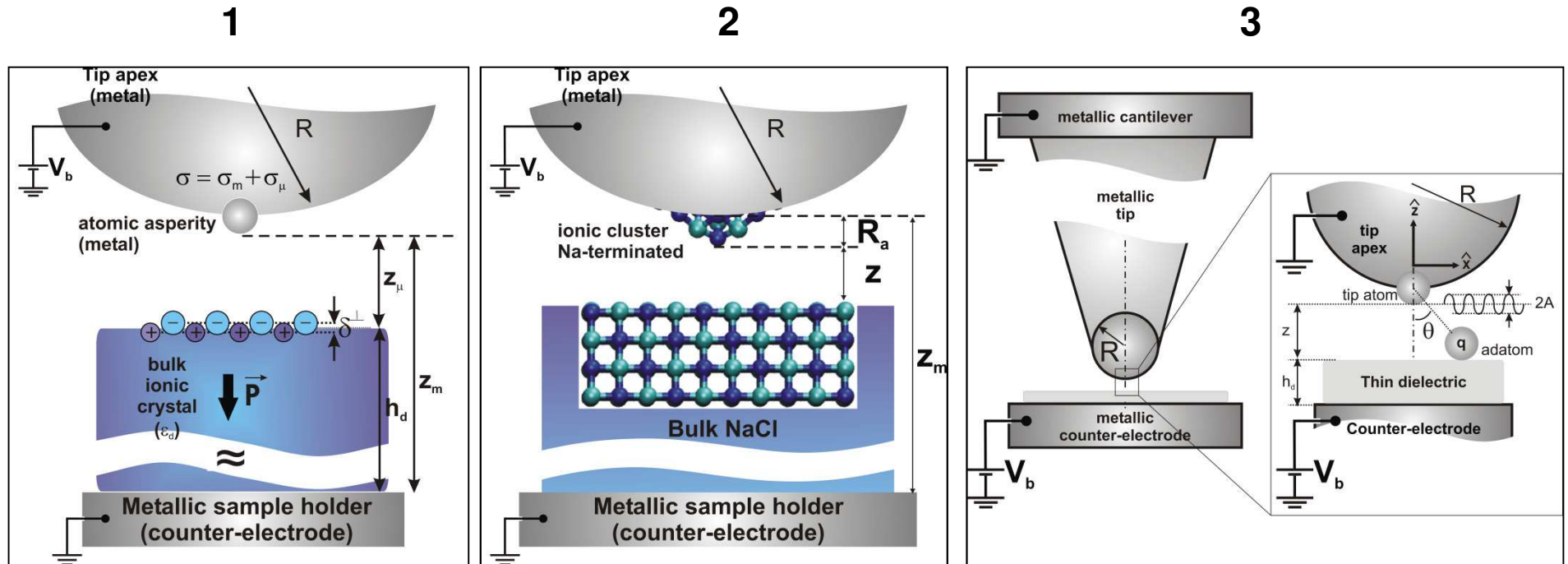

- **Tip termination:** metallic atomic asperity
- **Sample:** Bulk ionic crystal
- **Analytical & Experimental approach**

F.Bocquet et al., Phys. Rev. B **78**, 035410 (2008)
 L.Nony et al., Nanotechnology **20**, 264014 (2009)

- **Tip termination:** ionic cluster (Na⁺-terminated)
- **Sample:** Bulk ionic crystal
- **Fully numerical approach**

L.Nony et al., Phys. Rev. Lett. **103**, 036802 (2009)

- **Tip termination:** single metallic atom
- **Sample:** 2ML NaCl / Cu(111)
- **Fully analytical approach**

F.Bocquet et al., Phys.Rev.B **83**, 035411 (2011)
 Based upon the work by L.Gross et al. Science **324**, 1428 (2009)

SRE forces: influence of the polarization

- Atomistic force field including bias dependence (A. Foster):

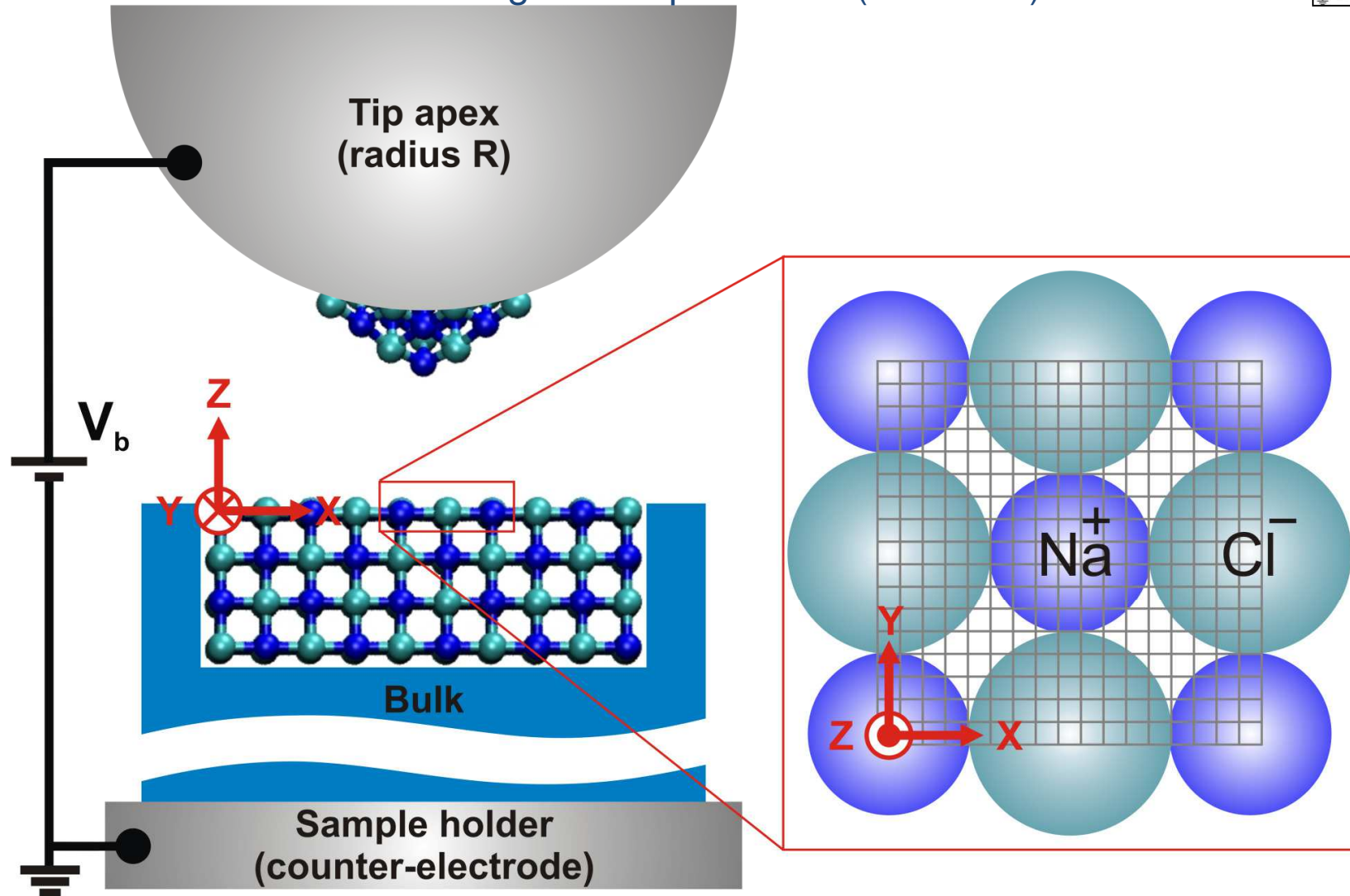
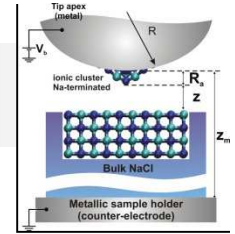

SRE forces: influence of the polarization

Force vs. V_{bias} at $z = 4.5 \text{ \AA}$:

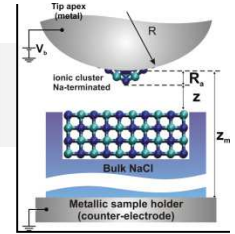
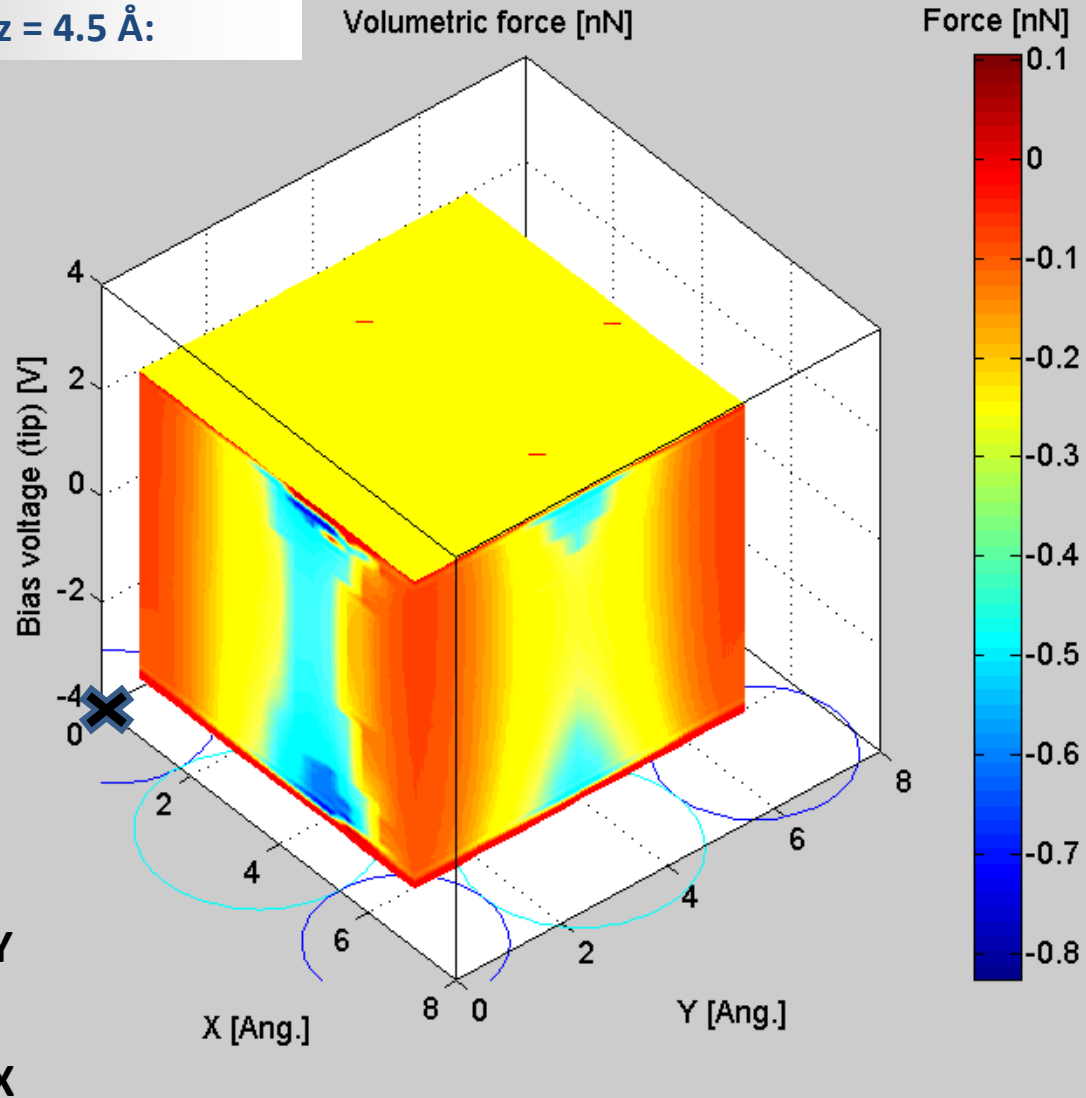

SRE forces: influence of the polarization

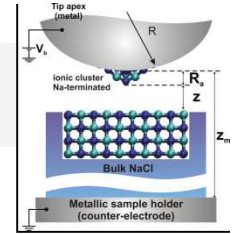

□ Force vs. V_b at $z = 4.5 \text{ \AA}$:

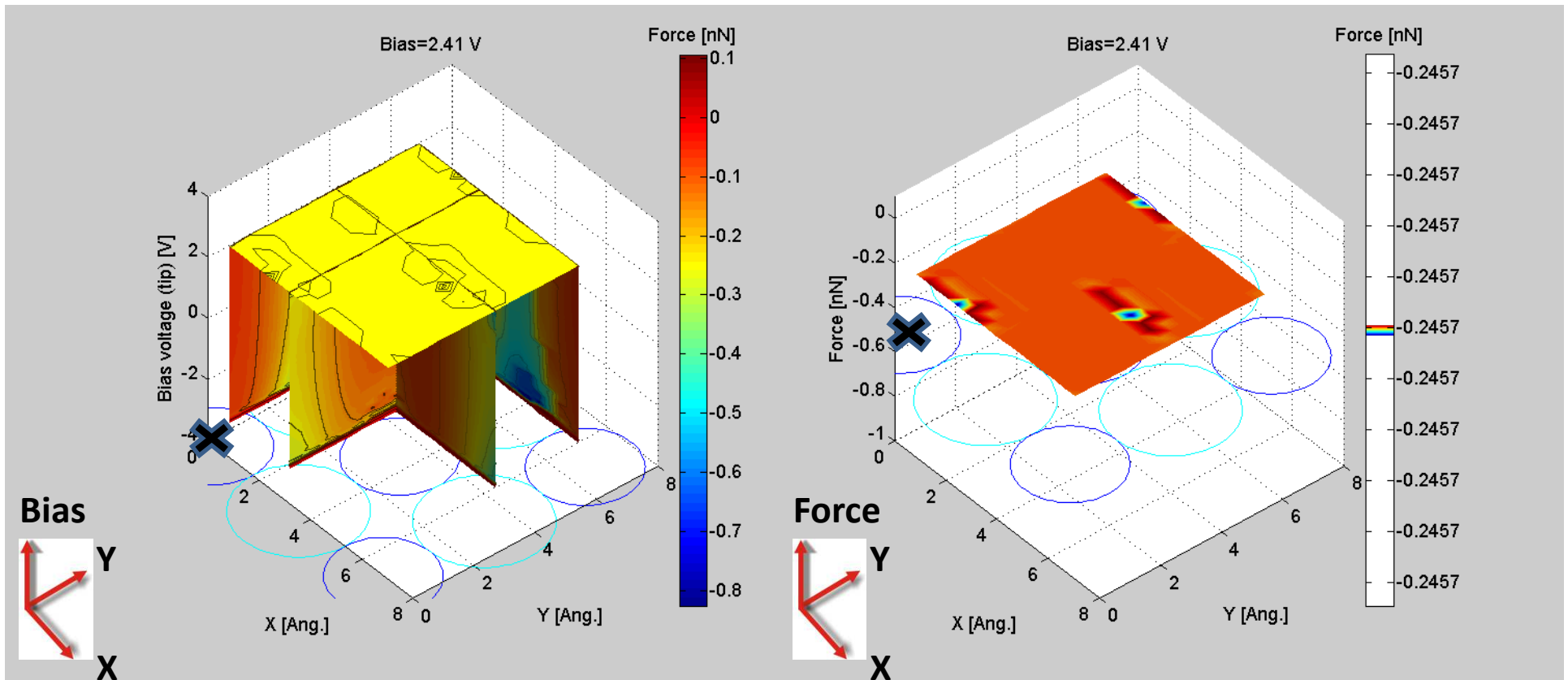

SRE forces: influence of the polarization

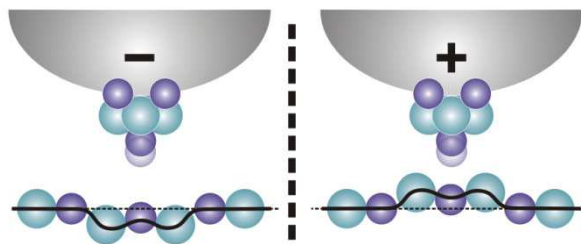
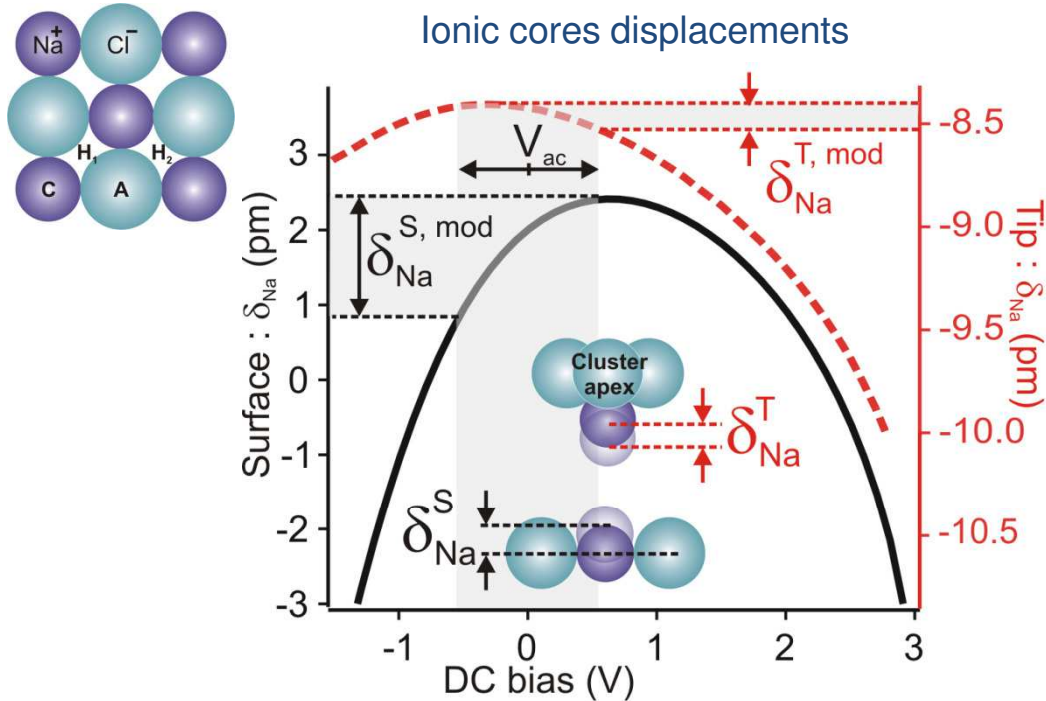
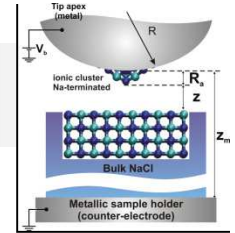

- ✓ Bias modulation → both electronic & ionic polarization (ionic displacements)
- ✓ Self-consistent coupling between SRE & chemical forces

LCPD atomic-scale contrast

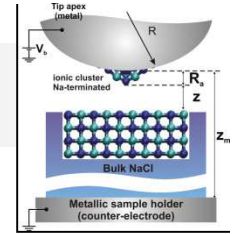

- nc-AFM/KPFM simulator:
 - ✓ Cantilever: $A_0 = 8 \text{ nm p-p}$; $f_0 = 150 \text{ kHz}$; $k_c = 30 \text{ N/m}$; $Q = 30000$
 - ✓ FM-KPFM: $V_{AC} = 0.5 \text{ V}$; $f_{mod} = 1 \text{ kHz}$
 - ✓ Scan speed : 1.5 s/line

Constant $\Delta f = -47.22 \text{ Hz}$ ($z_{start} \sim 0.45 \text{ nm}$)

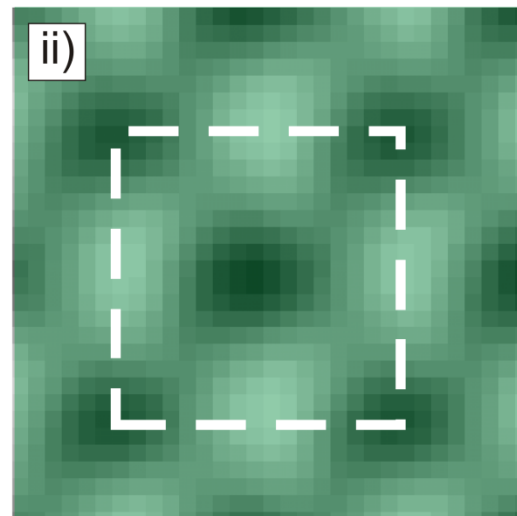
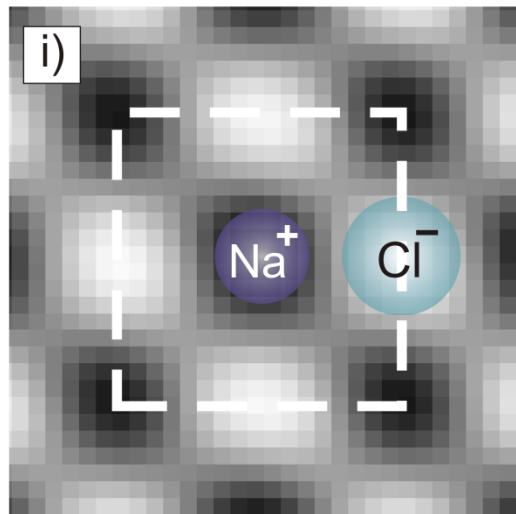

0 38 pm
Topography

-2.24V 0.56 V -1.69V
CPD

- ✓ Simultaneous atomic scale contrast in topography & CPD
- ✓ Contrast magnitude compliant with experimental data (30pm, 0.1V)
- ✓ Cross talk between topography & CPD when performing experiments at constant Δf

Charge state of a single atom

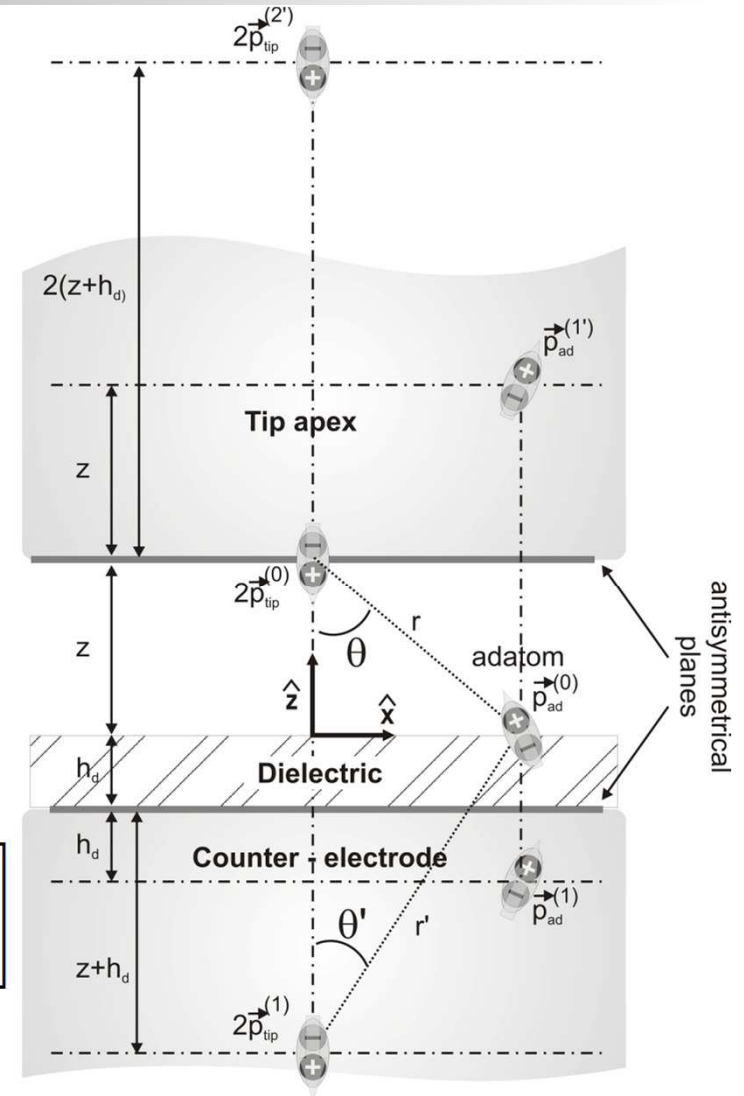
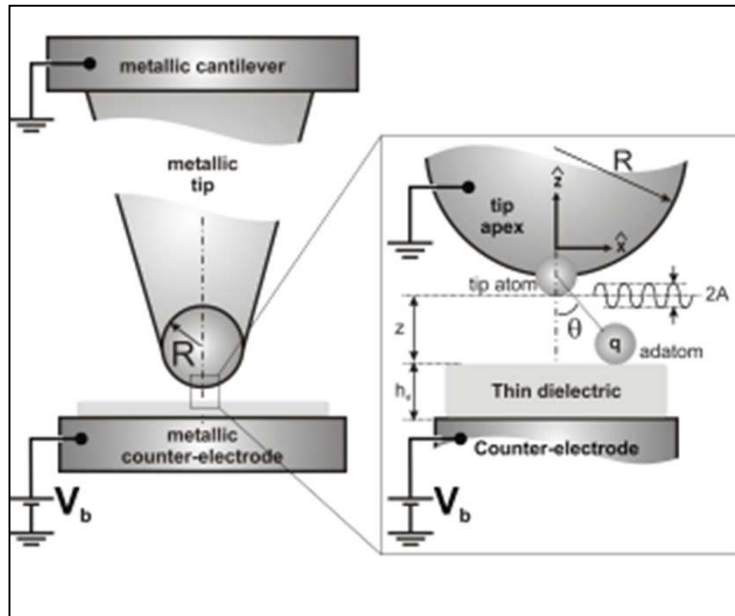

$$F_{SR}^{el} = -\frac{\partial}{\partial z} \left[-\frac{1}{2} \vec{p}_{tip} \cdot \vec{E}_{tip}^{ext} - \frac{1}{2} \vec{p}_{ad} \cdot \vec{E}_{ad}^{ext} \right]$$

Charge state of a single atom

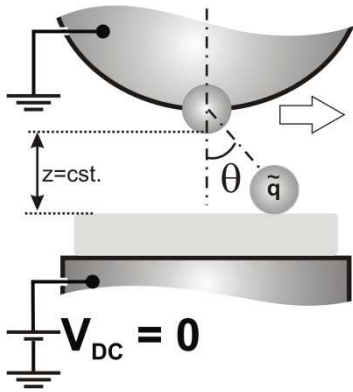
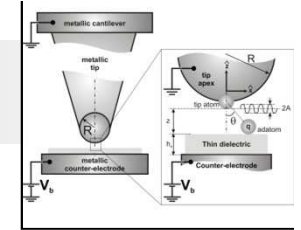

Polarizability for Gold: $\alpha=6.78\text{\AA}^3$

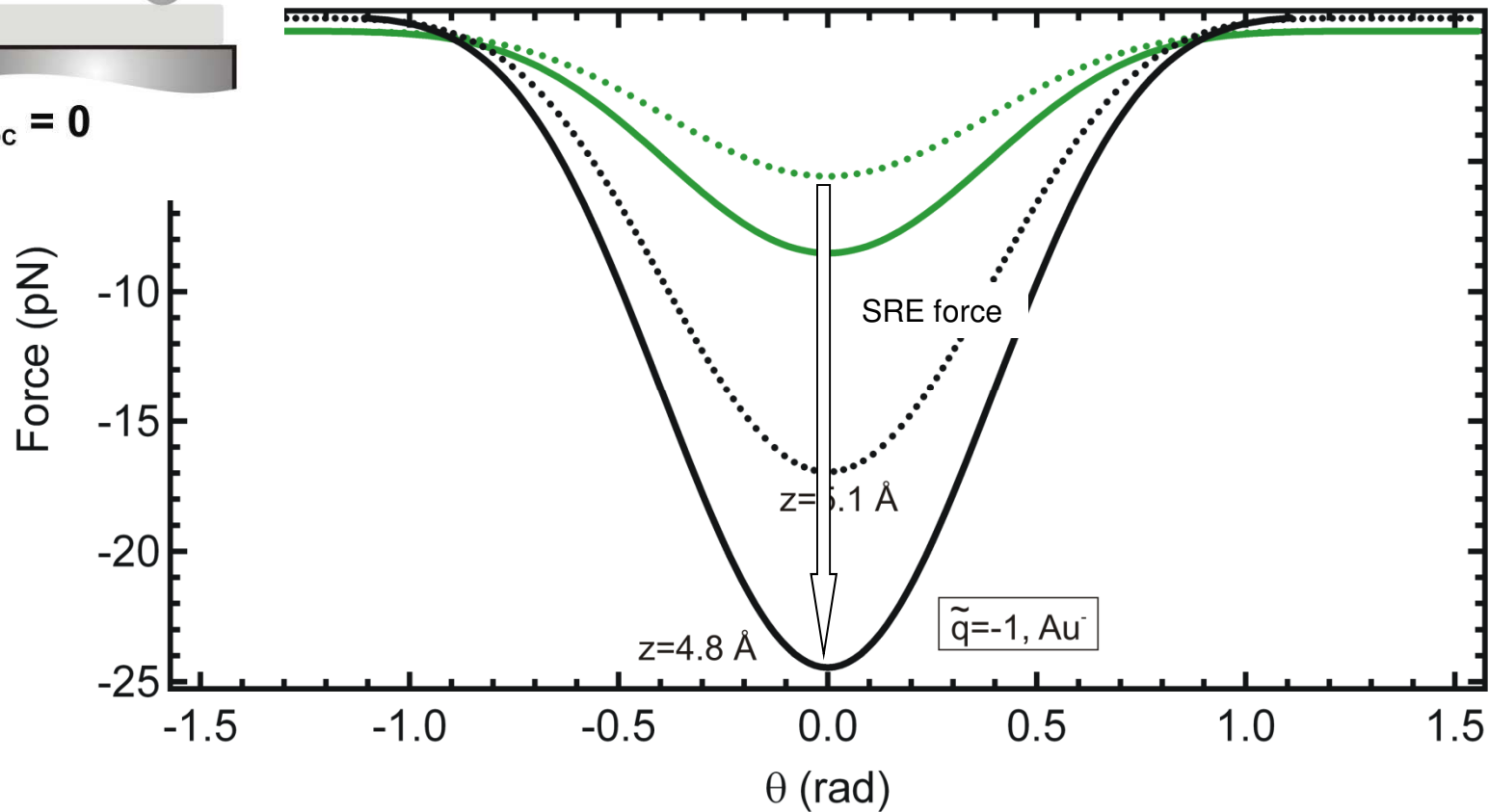

Charge state of a single atom

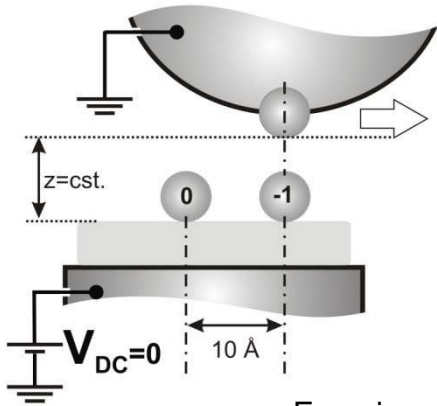
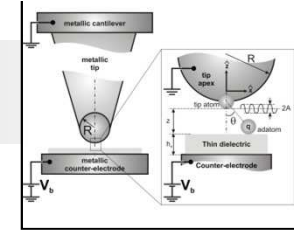

$$\text{Force} \rightarrow \Delta f = -\frac{f_0}{2k} \frac{\partial F}{\partial z}$$

Δf derived from the total force (LR+SR components, $z = 5.1 \text{ \AA}$, $R = 50 \text{ \AA}$)

Experimental data by L.Gross et al.

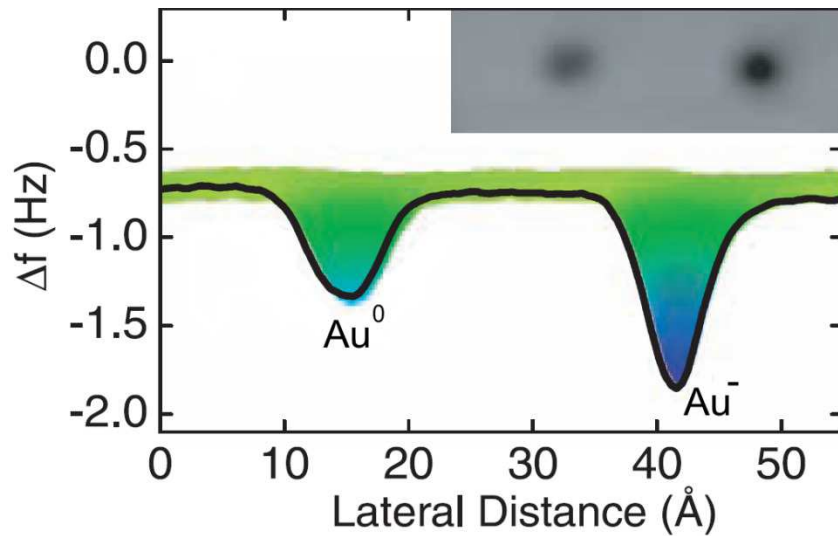

Cross section derived from the model

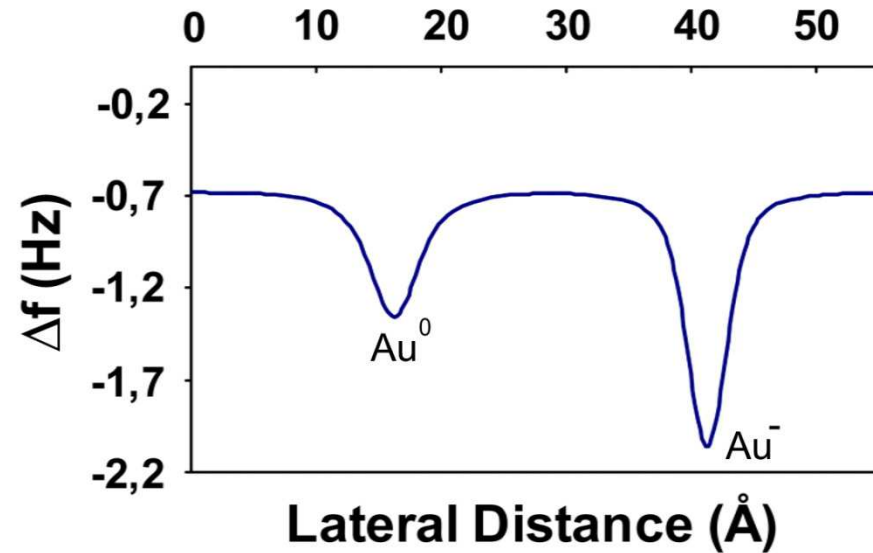

Charge state of a single atom

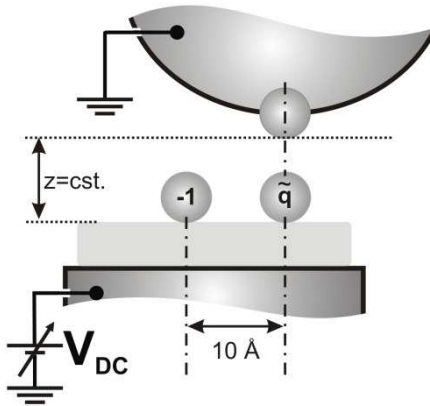
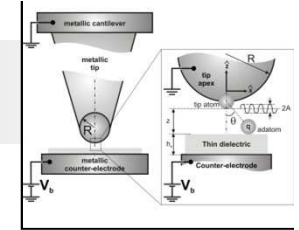

$$\text{Force} \rightarrow \Delta f = -\frac{f_0}{2k} \frac{\partial F}{\partial z}$$

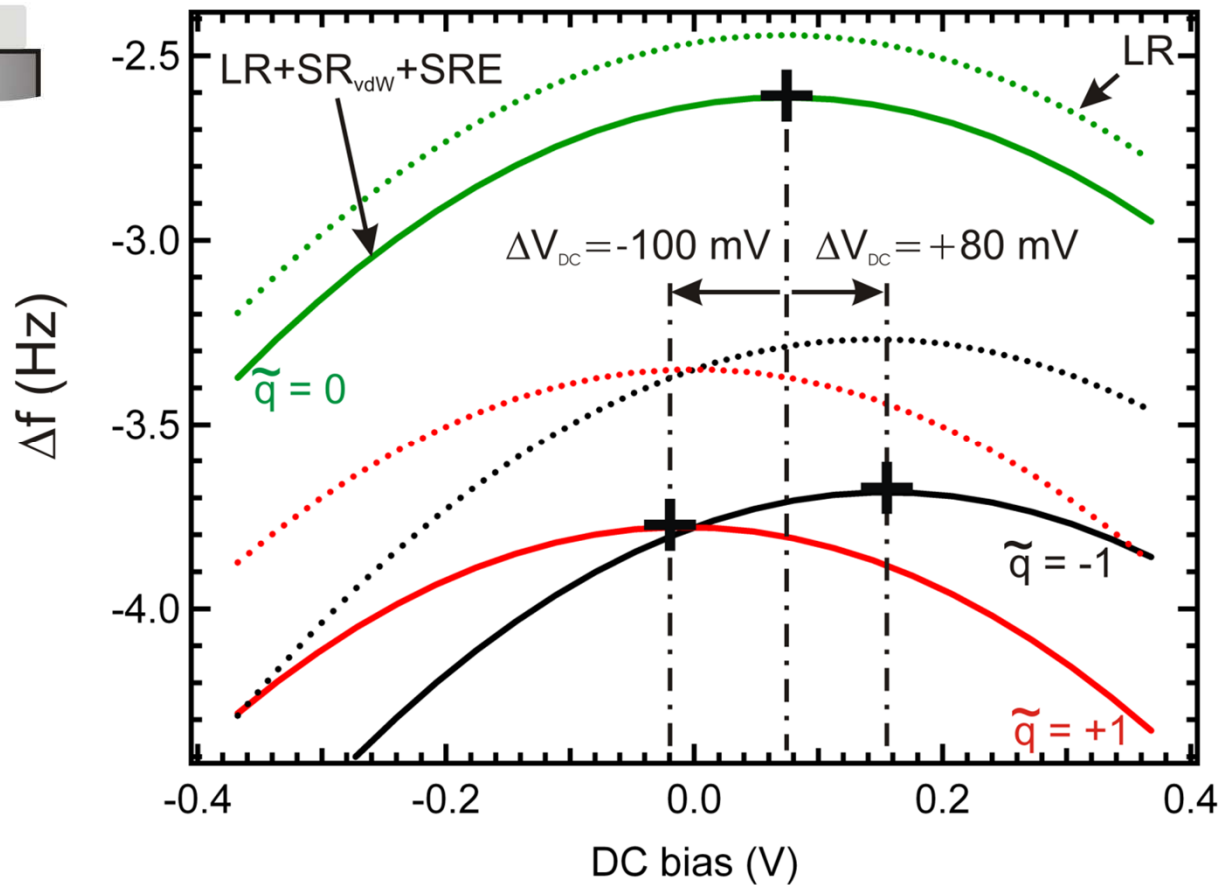

Δf derived from the total force (LR+SR components, $z = 5.8 \text{ \AA}$, $R = 50 \text{ \AA}$)



Conclusion

Take home message

Context: KPFM & nc-AFM in UHV, distance to the surface $\sim < 1$ nm, large amplitudes, metallic samples covered with a thin dielectric or bulk insulators

- ❑ Compensating electrostatic forces is required for high-resolution nc-AFM imaging → necessity for using KPFM
- ❑ Technic adds further complexity to the experimental setup but... 
- ❑ There is no obvious reason for choosing FM- rather than AM-KPFM mode so far...
- ❑ The sign of the charges or the dipole orientation of the species trapped within the capacitance which shift the CPD w.r.t. CPD_{ref} (background) is easy to determine
- ❑ BUT getting quantitative numbers out of the experimental data is difficult (requires complex models) as the CPD is tip and distance dependent 
- ❑ SRE forces yield a spatially-consistent map of the local CPD, but...

Key references used for this talk

- W. Melitz et al., *Kelvin Probe Force Microscopy and its application*, Surf. Sci. Rep. **66**, 1-27 (2011)
- *Kelvin Probe Force Microscopy, Measuring & Compensating Electrostatic forces*, Springer Series in Surface Sciences (Th. Glatzel & S. Sadewasser Ed.)
- B.D. Terris et al., *Contact electrification using force microscopy*, Phys. Rev. Lett. **63**, 2669 (1989)
- R. Stomp et al., *Detection of single-electron charging in an individual InAs quantum dot by noncontact atomic-force microscopy*, Phys. Rev. Lett. **94**, 056802 (2005)
- Y. Azuma et al., Phys. Rev. Lett. **96**, 016108 (2006)
- L. Gross et al. *Measuring the charge state of an adatom with noncontact atomic force microscopy*, Science **324** :1428–1431 (2009)
- F. Mohn et al. *Imaging the charge distribution within a single molecule*, Nature Nanotechnology **7(4)**, 227–231 (2012)
- C. Barth et al., *AFM tip characterization by kelvin probe force microscopy*, New J. Phys. **12**, 093024 (2010)
- H. Jacobs et al. J. Appl. Phys. **84**, 1168 (1998).
- J. Colchero et al. Phys. Rev. B **64**, 245403 (2001).
- T. Glatzel et al. Appl. Surf. Sci. **210**, 84 (2003).
- A. Gil et al. Nanotechnology **14**, 332 (2003).
- K. Sajewicz et al. Jap. J. Appl. Phys. **49**, 025201 (2010).

Acknowledgements

Ch. Loppacher (Pr.), F. Bocquet (MC), L.Nony (MC), F. Para (IE), A. Amrous (PhD)



