



HAL
open science

Magnetic nanoparticles: synthesis, properties and biomedical applications

Olivier Sandre

► **To cite this version:**

Olivier Sandre. Magnetic nanoparticles: synthesis, properties and biomedical applications. Master. Física Aplicada, Universidad de Granada, Spain. 2017, pp.62. cel-02105959

HAL Id: cel-02105959

<https://cel.hal.science/cel-02105959v1>

Submitted on 22 Apr 2019

HAL is a multi-disciplinary open access archive for the deposit and dissemination of scientific research documents, whether they are published or not. The documents may come from teaching and research institutions in France or abroad, or from public or private research centers.

L'archive ouverte pluridisciplinaire **HAL**, est destinée au dépôt et à la diffusion de documents scientifiques de niveau recherche, publiés ou non, émanant des établissements d'enseignement et de recherche français ou étrangers, des laboratoires publics ou privés.



Distributed under a Creative Commons Attribution - NonCommercial - ShareAlike 4.0 International License

olivier.sandre@u-bordeaux.fr

@olive_free



MAGNETIC NANOPARTICLES: SYNTHESIS, PROPERTIES AND BIOMEDICAL APPLICATIONS

Olivier Sandre, senior CNRS researcher at Univ. Bordeaux, France



UGR

Universidad
de Granada



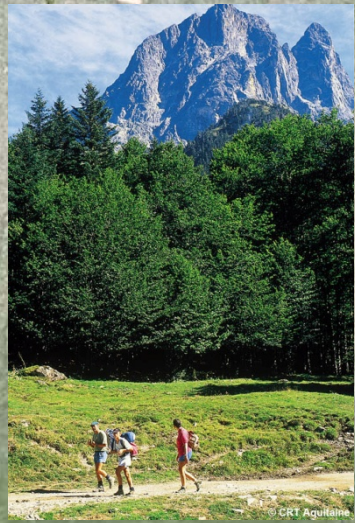

Magnetic nanoparticles (MNPs) Part 1: Synthesis and physical properties

- Part 1A: Chemistry of iron oxides and oxo-hydroxides:

Diversity of methods to prepare colloidal nanoparticles, either in non aqueous solvents: hydrothermal synthesis, polyol synthesis, thermal decomposition... or in water: alkaline co-precipitation of iron salts (also in EG, DEG...)

- Part 1B: Magnetic behavior (ferro- /ferri- /antiferro- /superpara– magnetism...) and optical properties of MNPs (UV-vis absorption, magnetic birefringence)

- Part 1C: MNPs as contrast agents in Magnetic Resonance Imaging
Universal law for relaxometry (T_1/T_2 of water H spins near MNPs)

All properties are highly sensitive on MNP's size and shape (poly)dispersity!

- Part 2A Magnetic Hyperthermia ('Tumor catabolism')

- Part 2B Nanomedicines – Magnetic carrier – Magnetic Guiding ('Tumor homing')

- Part 2C Drug Delivery Systems (DDS) based on Magnetic Core@Polymer Shells, Magnetic Polymer Shells, Magnetic Micelles, or Vesicles ('Polymersomes')

The Iron Oxides (Rochelle M. Cornell, Udo Schwertmann)



From solution of Fe^{2+} et Fe^{3+} salts towards solid phase

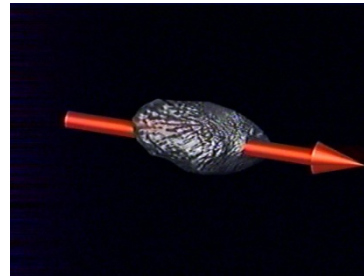
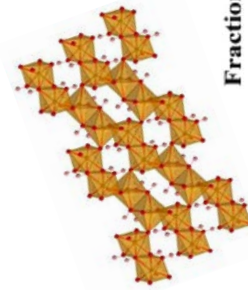
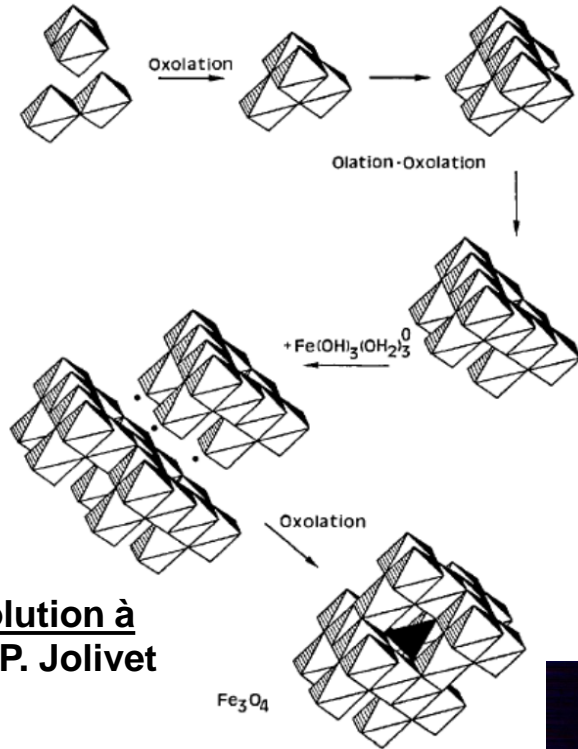

- ⊕ O^{2-}
- Fe^{3+} tetrahedral site
- Fe^{2+}/Fe^{3+} octahedral site

Spinnelle structure

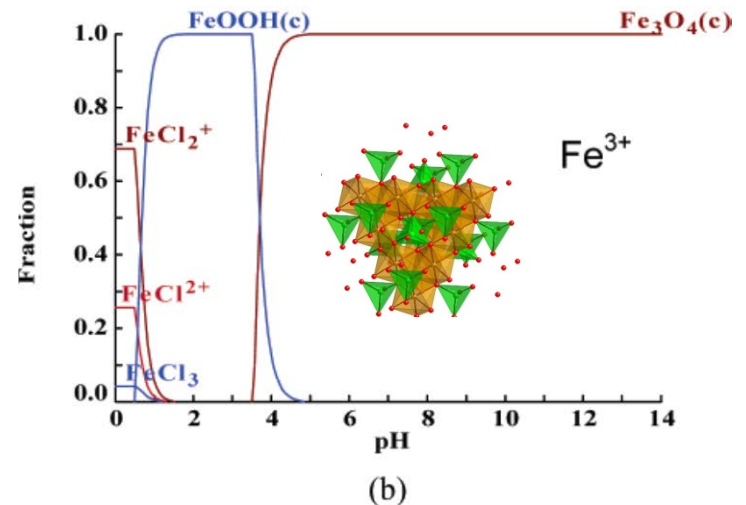
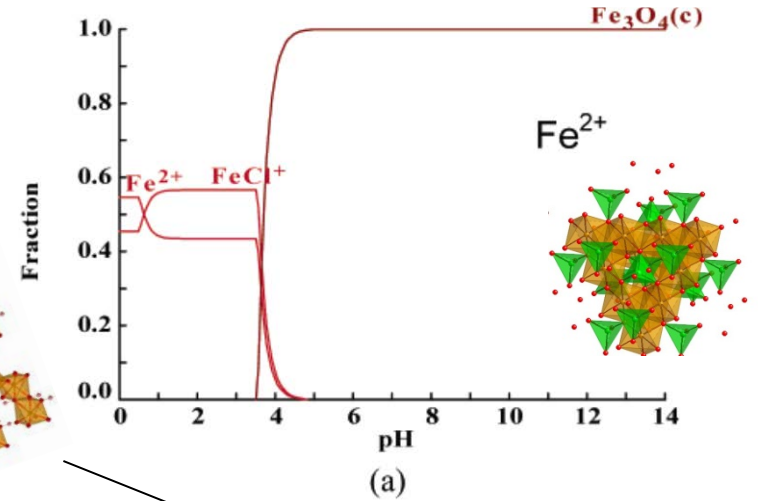

D.K. Kim et al.,
Chem. Mater. 2003, 15, 1617-1627

Very narrow pH stability of $\text{Fe}^{3+}(\text{H}_2\text{O})_6$ soluble ion

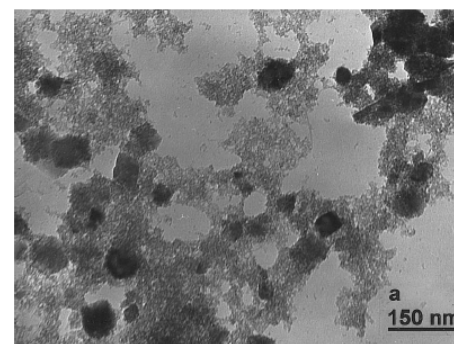
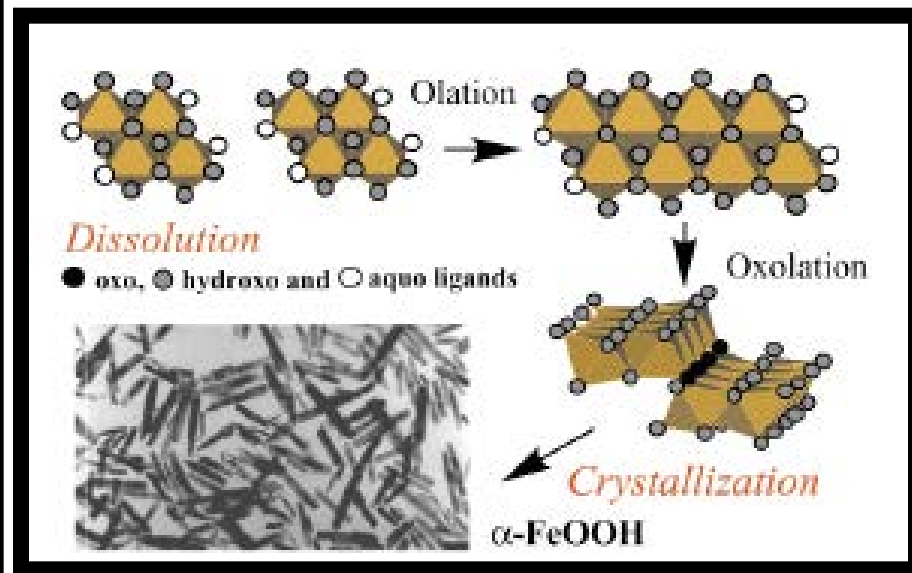
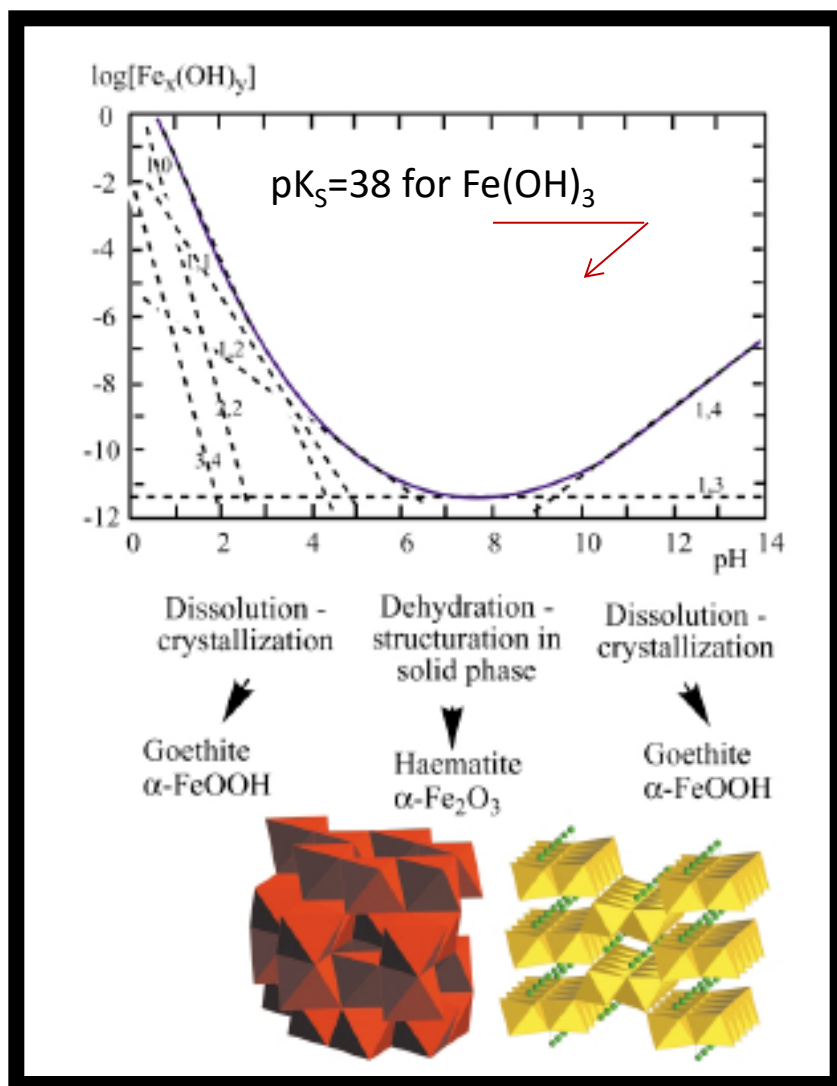

Jean-Pierre Jolivet,

Chem. Commun., 2004, 481-487

Antiferromagnetic clays made of iron^{III} oxo-hydroxides

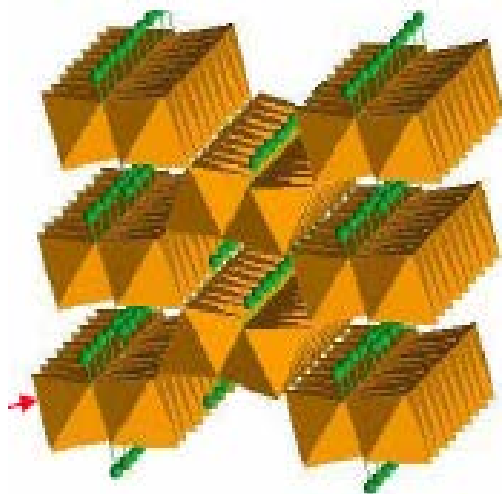
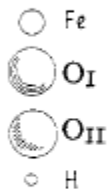
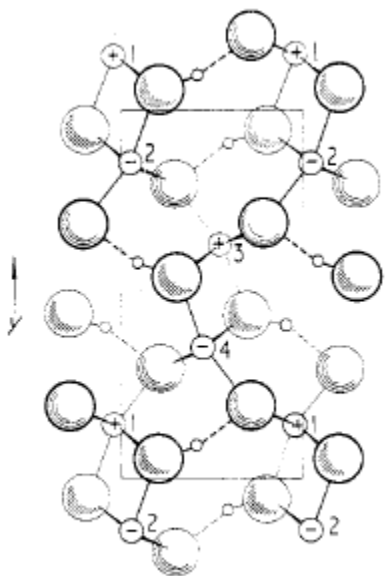

Orthorhombic structure of $\gamma\text{-FeOOH}$
(Fe³⁺ in octahedral sites)

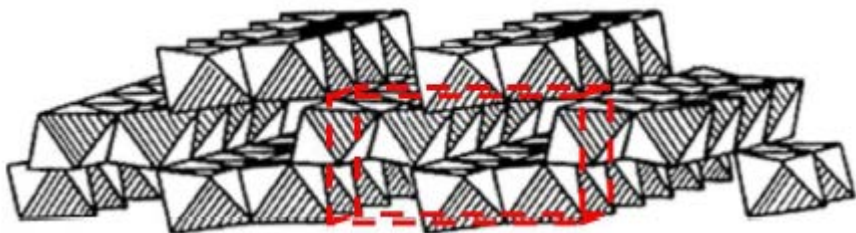

Goethite is **antiferromagnetic**

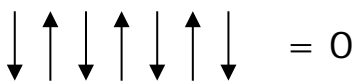

Resulting
magnetization

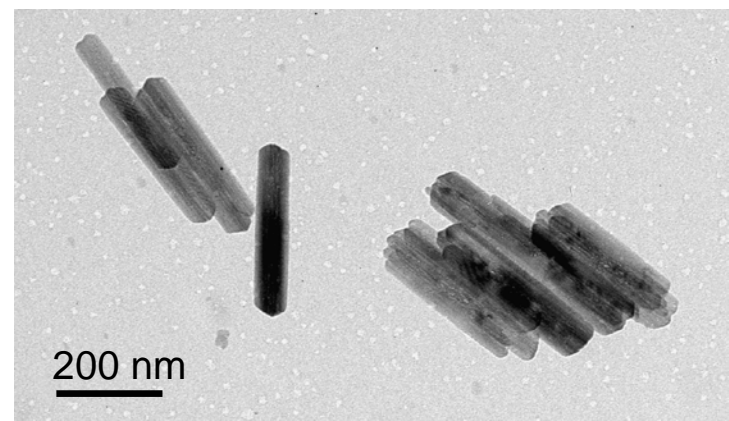

Goethite nanolaths $\gamma\text{-FeOOH}$
(rod-like)

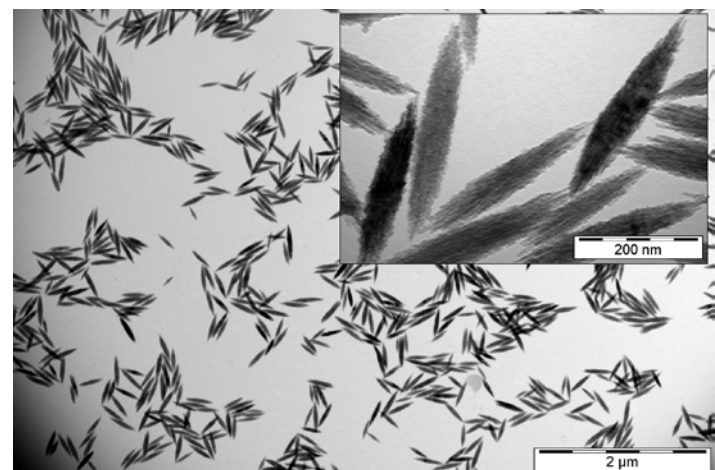

Accicular Haematite $\alpha\text{-Fe}_2\text{O}_3$
(spindle-like)

Synthesis of antiferromagnetic goethite nanorods

1/ ferrihydrite alkaline precipitation

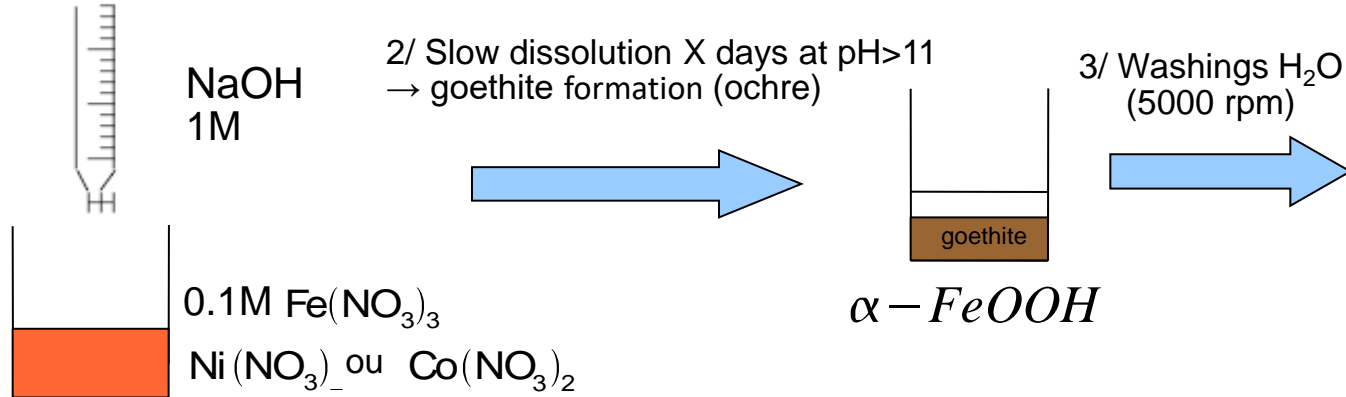

Dispersion in HNO_3 at pH=3

- PhD thesis J. Hernandez (UPMC 1998):
10 days ageing at $T=25\text{C}$ & pH13

- S. Krehula et al. (Mat. Lett. 2002): hydrophobic base (TMAOH)
Ageing during 1 – 21 days + “forced hydrolysis” ($T=60 - 160\text{C}$)

- D. Thies-Weesie et al. (Chem. Mater. 2007)
Size-sorting by centrifugation steps

- Thermal decomposition Fe^{III} -oleate
Taekyung Yu et al. (JACS 2007)

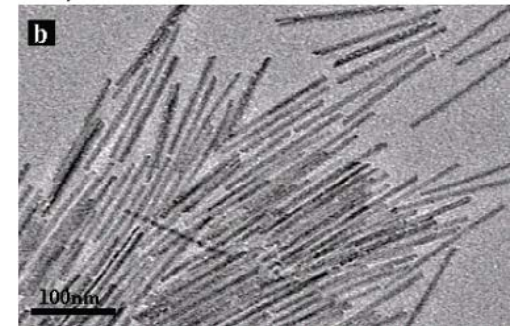
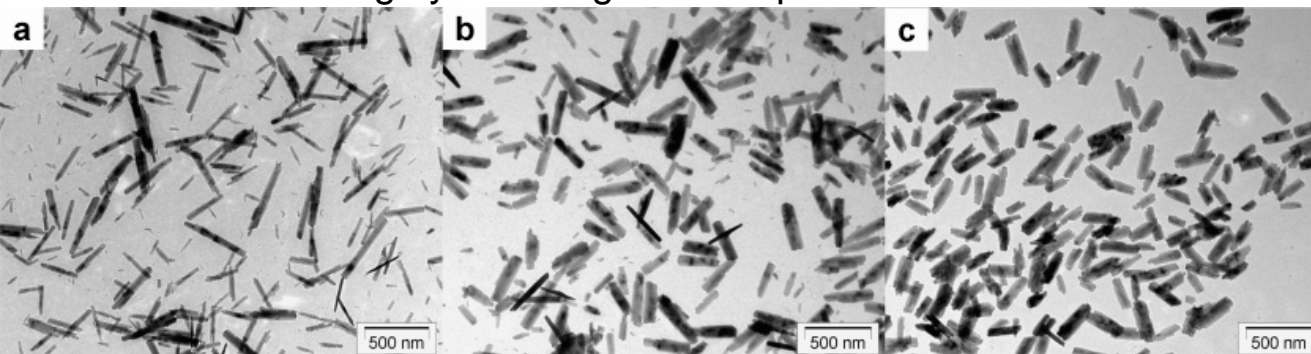
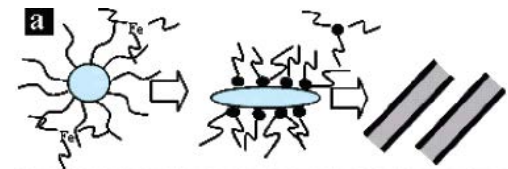

Doping of goethite nanorods with M^{n+} cations

- U. Schwertmann & R.M. Cornell, Iron Oxides in the Laboratory (1991)
- B. Sing et al., Clay Minerals 2002 → Cr^{3+} , Mn^{3+} , Ni^{2+}
- M. Mohapatra et al., Hydrometallurgy 2002 → Cu^{2+} , Ni^{2+} , Co^{2+} , Mat. Chem. Phys. 2005 → Ce^{4+}

Ageing conditions: 24h in oven at 70° C – pH=11-12

Sample	pH _{ageing}	Ni/Fe	Φ v/v	D _{hyd} nm
T	11.1	0	0.21%	205
1Ni	11	0.6%	0.19%	198
5Ni	11.9	2.4%	0.17%	142
10Ni	12	2.8%	0.10%	168

Sample	pH _{ageing}	Co/Fe	Φ v/v	D _{hyd} nm
T	11.1	0	0.21%	205
1Co	12	1.0%	0.25%	284
5Co	12.2	2.6%	0.15%	169
10Co	12.2	9.6%	0.02%	238

XRPD: no trace of $Ni(OH)_2$ → nickel on surface

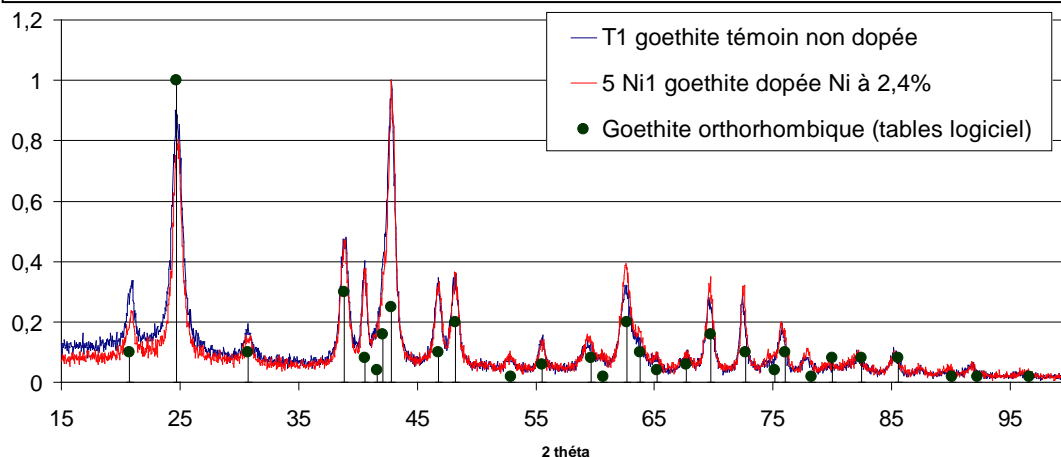

α -FeOOH: orthorhombic mesh $a=9.95\text{\AA}$ $b=3.01\text{\AA}$ $c=4.62\text{\AA}$

1 μ m

1 μ m

Goethite nanorods doped with Co^{2+}

Goethite doped at 1%Co

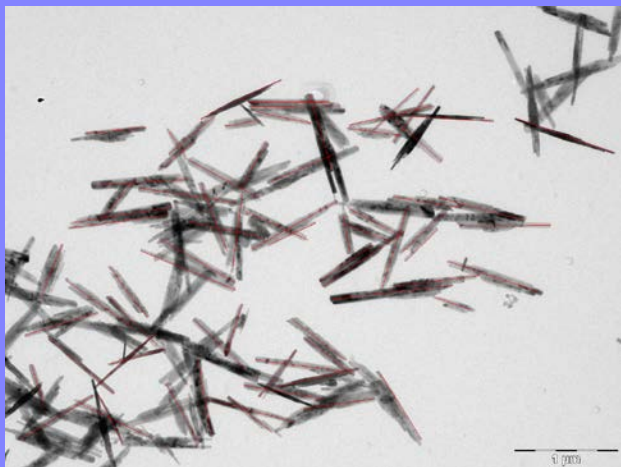

Hydrodynamic diameter = 284 nm
Mean length by TEM = 715 nm

Goethite doped at 10%Co

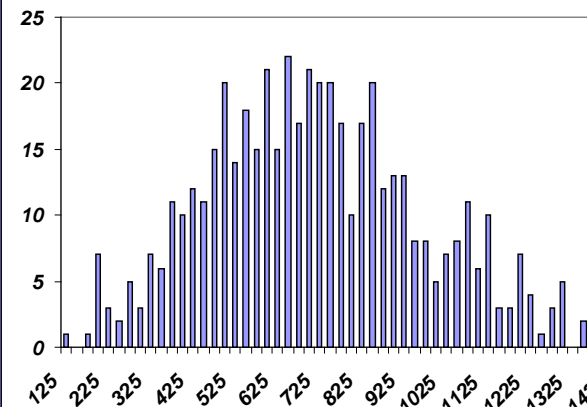

Large size associated with interesting magnetic properties (1Co1 sample)

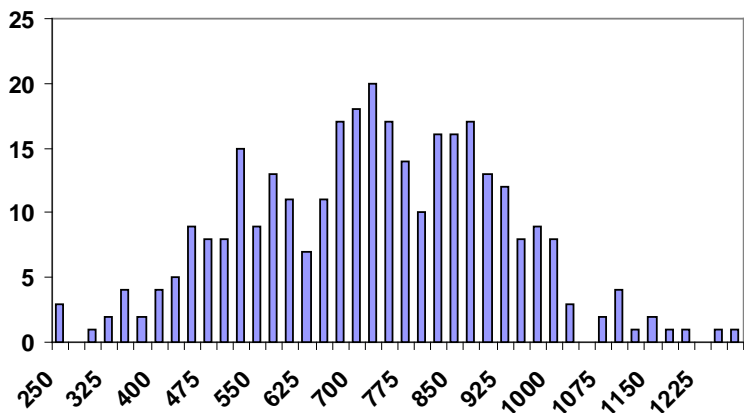

Non monotonous effect of Co doping on rods' size:

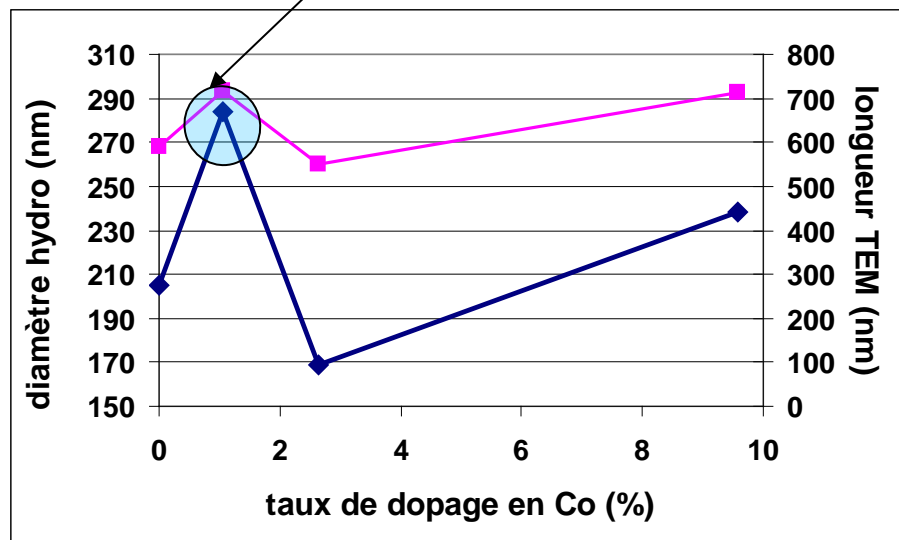

Antiferromagnetic nanorods of even smaller sizes

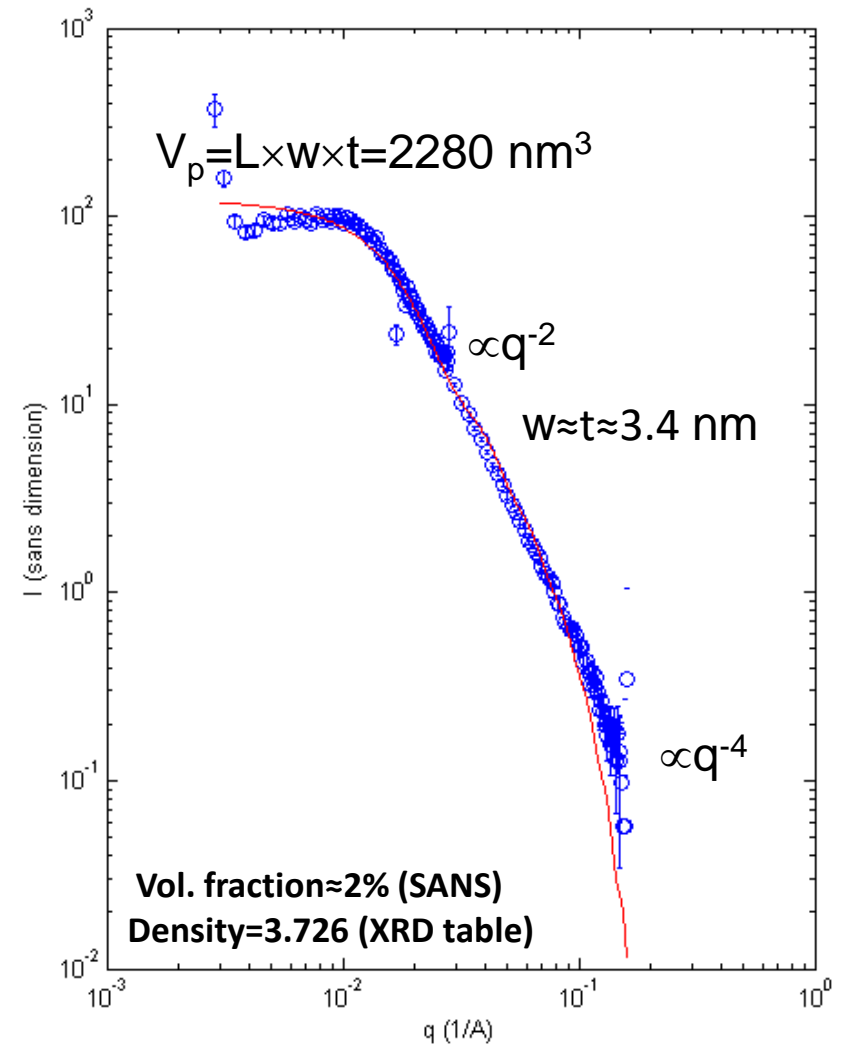
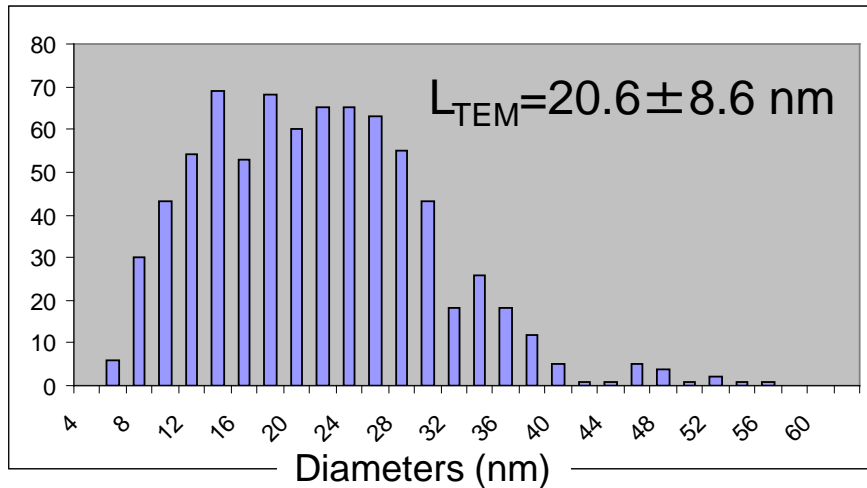
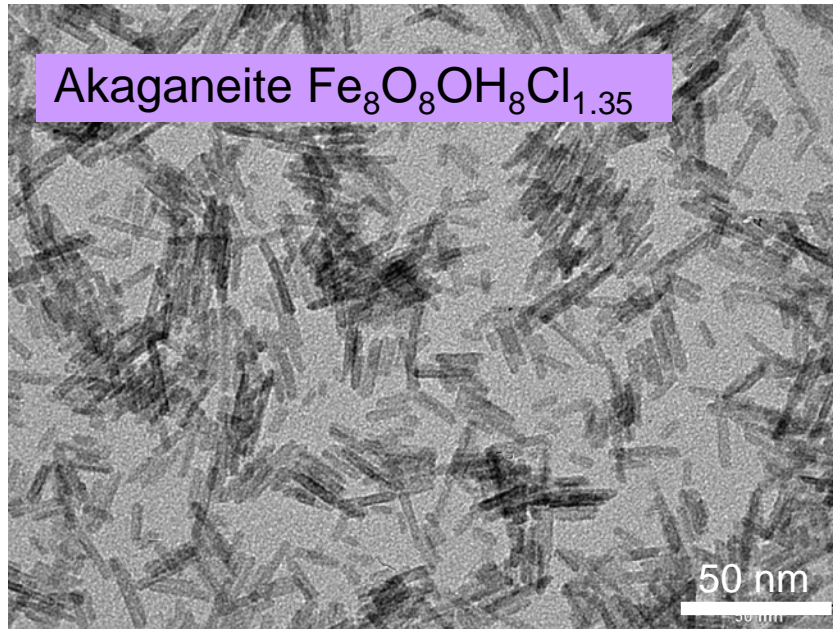

SANS on PAXY LLB-Saclay (oct. 2008)

Magneto-orientational behavior of a suspension of anti-ferromagnetic nanoparticles (NAF)

J. Phys.: Condens. Matter **20** (2008) 204120 Yu L Raikher, V. I. Stepanov (Perm, Russia) :

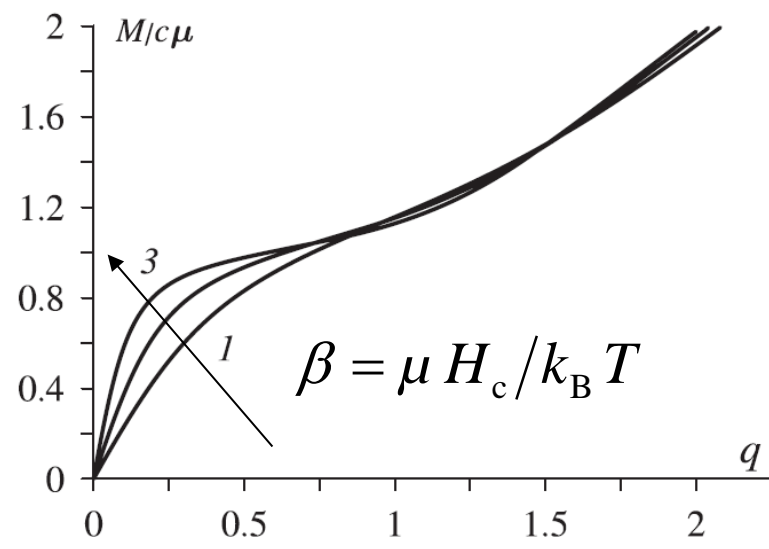

$$U = -\mu (\vec{e} \cdot \vec{H}) + \frac{1}{2} \chi_A V (\vec{e} \cdot \vec{H})^2$$

Figure 1. Reduced static magnetization of a NAF colloid

$$H_c = \mu / \chi_A V$$

$$\chi_A = \chi_{||} - \chi_{\perp}$$

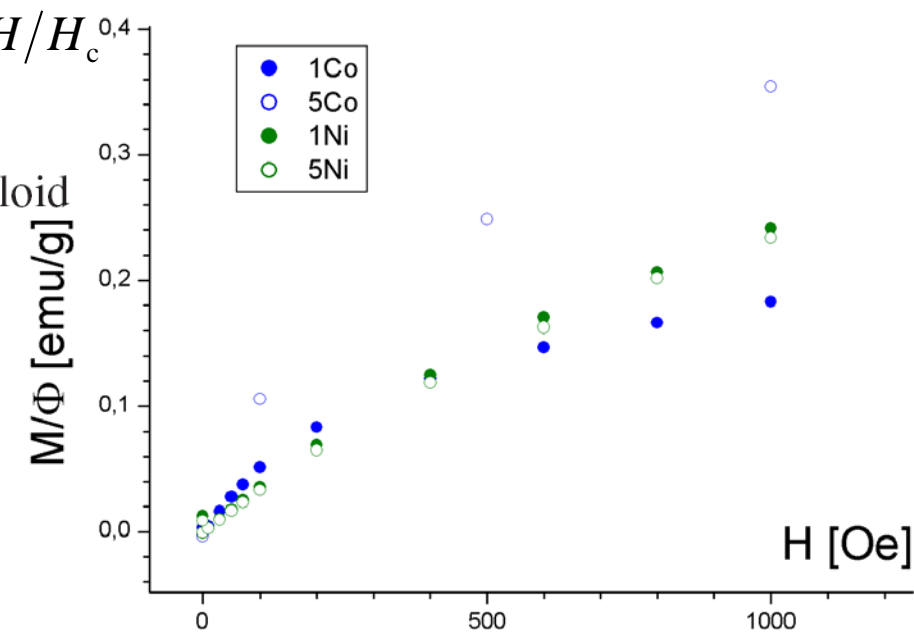

Magnetic behavior of antiferromagnetic nanorods

SQUID magnetometry at ambient temperature*

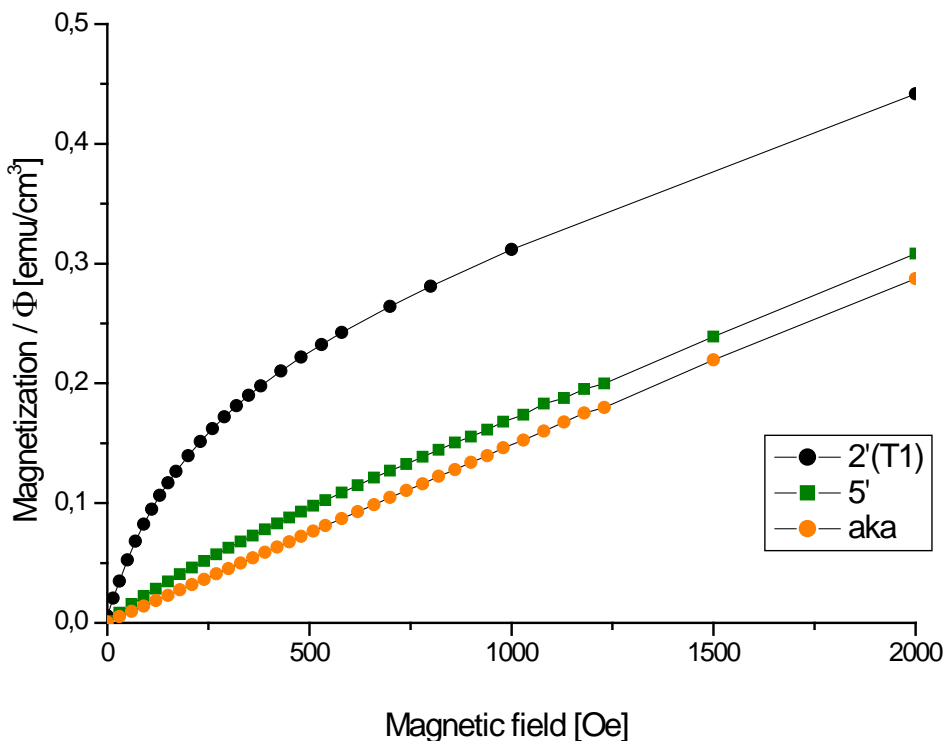

*measurement at INSP lab. (UPMC)

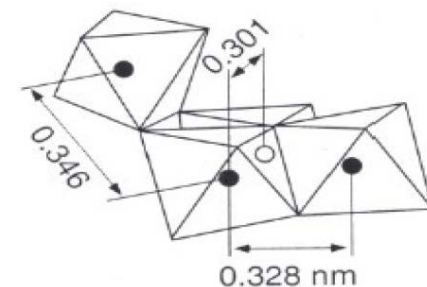

$$\mu_{\text{Fe+III}} = 5 \mu_B$$

$$\mu \approx 10000 \mu_B \approx (N_{\text{Fe}})_{\text{surf}}^{1/2} \mu_{\text{Fe}}$$

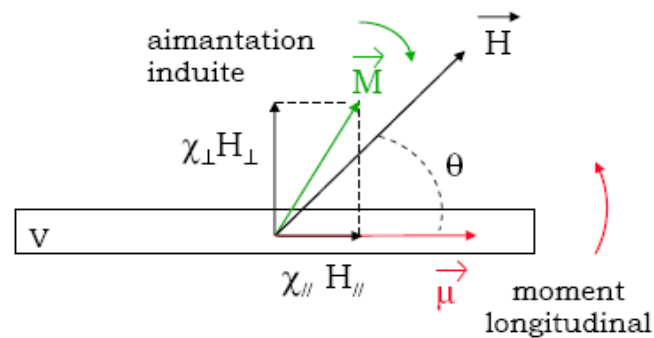

B. Lemaire, P. Davidson (LPS Orsay)

Magnetite: Crystalline Structure

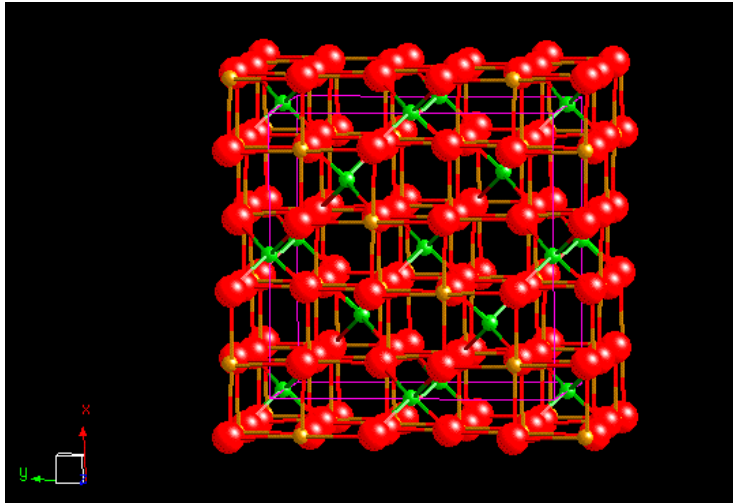

Magnetite is **ferrimagnetic**

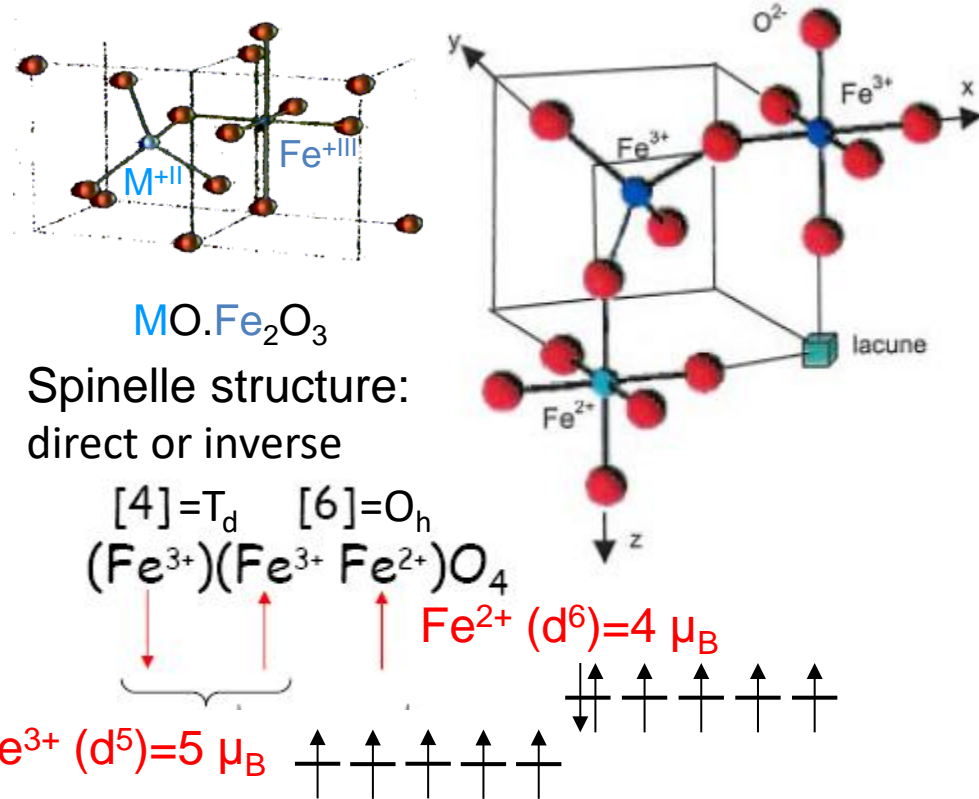
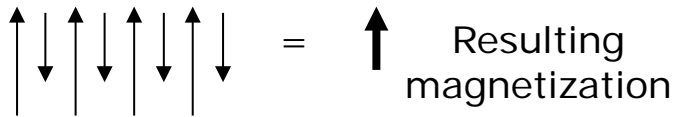

Exercise: 1/calculate specific volume ($cm^3 \cdot mol^{-1}$) and mesh size a

Data: one unit cell is cubic and contains 8 Fe_3O_4 molecules

Mass density $\rho = 5.18 \times 10^3 \text{ kg} \cdot m^{-3}$, Molar mass $M = 231.535 \text{ g} \cdot mol^{-1}$

1 Bohr magneton $\mu_B = 9.274 \times 10^{-24} \text{ A} \cdot m^2$

2/calculate the specific magnetization M_S of bulk Fe_3O_4 in $A \cdot m^{-1}$

Answers:

$v = 45 \text{ cm}^3 \cdot mol^{-1}$

$a = 8.396 \text{ \AA}$

$M_S = 5 \times 10^5 \text{ A} \cdot m^{-1}$

Magnetic domains and Bloch boundaries (walls)

Macroscopic magnets (bulk materials) are multi-domains

Size of mono-domain: ~ 30-50 nm for iron oxides

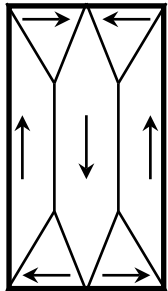

Rosensweig 1965, Néel 1955, Kittel 1946, Elmore 1938

Curie-Weiss
domains



One ~ 10 nm nanoparticle is a magnetic single domain

Bloch walls

Exercise:

- 1: calculate magnetic moment (in nb of μ_B /MNP) for diameters: $d=4 / 8 / 16$ nm
- 2: calculate total nb of Fe ions per MNP for all d 's
- 3: calculate nb of Fe ions on surface per MNP for all d 's

Data:

- 1 Bohr magneton $\mu_B=9.274 \times 10^{-24}$ A·m²
- For nano-crystalline Fe_3O_4 , $M_S = 4 \times 10^5$ A·m⁻¹

Answer:

- 1: 1500 / 11000 / 90000 2: 1400 / 10700 / 87000
- 3: 290 (20%) / 1100 (10%) / 4500 (5%)

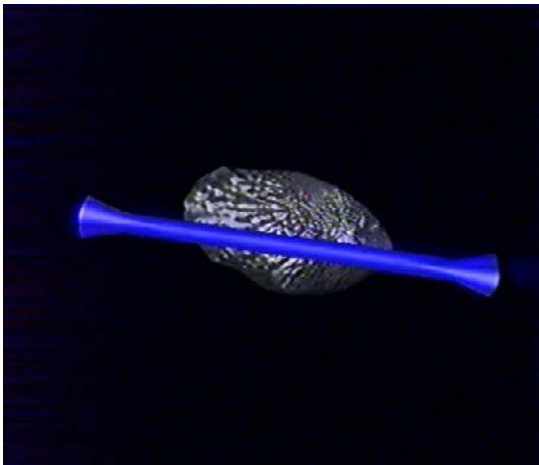

Shape anisotropy contribution to birefringence

"Rock-like" particles: S1C fraction, coated with PAA_{2k}

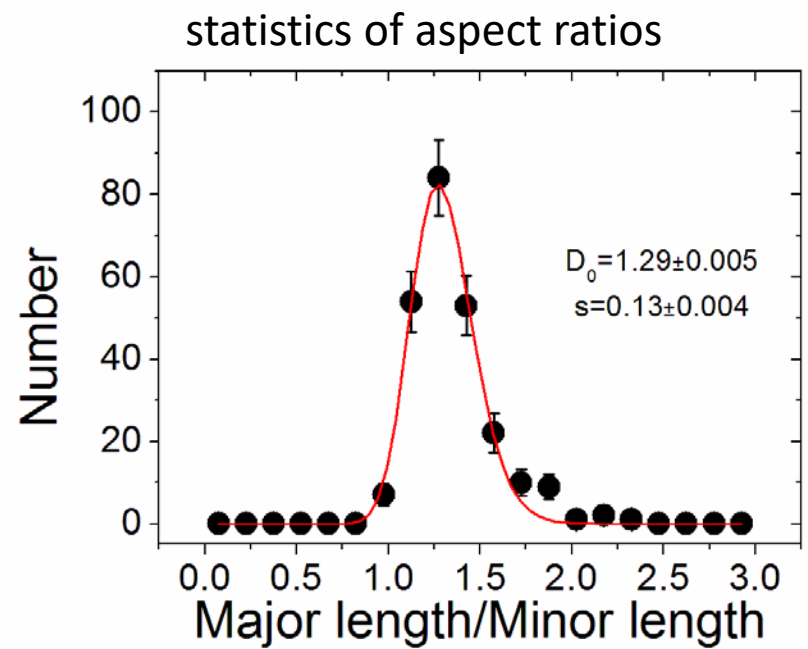
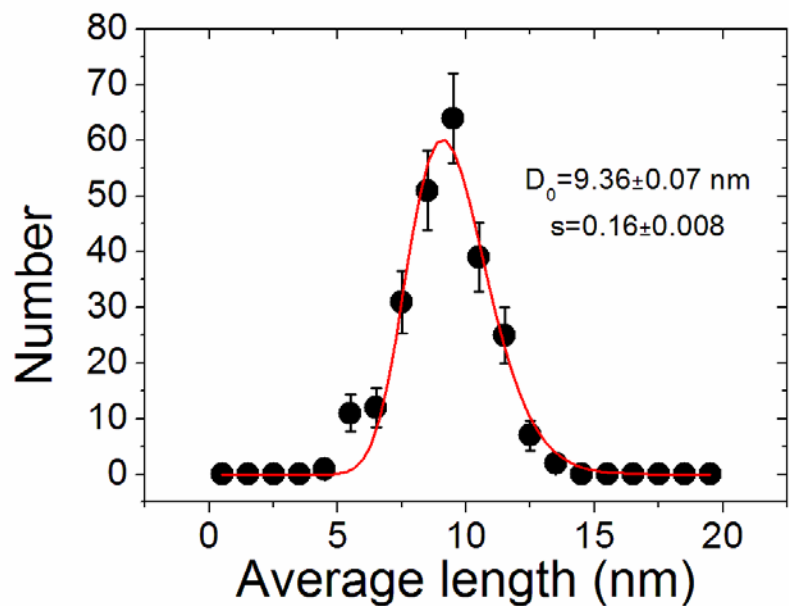

50 nm

Birefringence measurement under H field

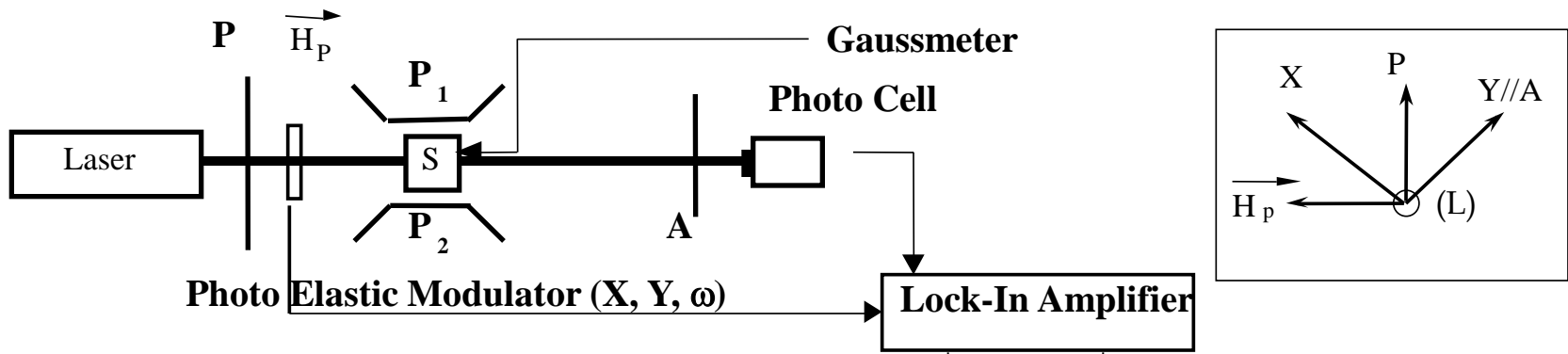

E. Hasmonay et al. EPJB 1998

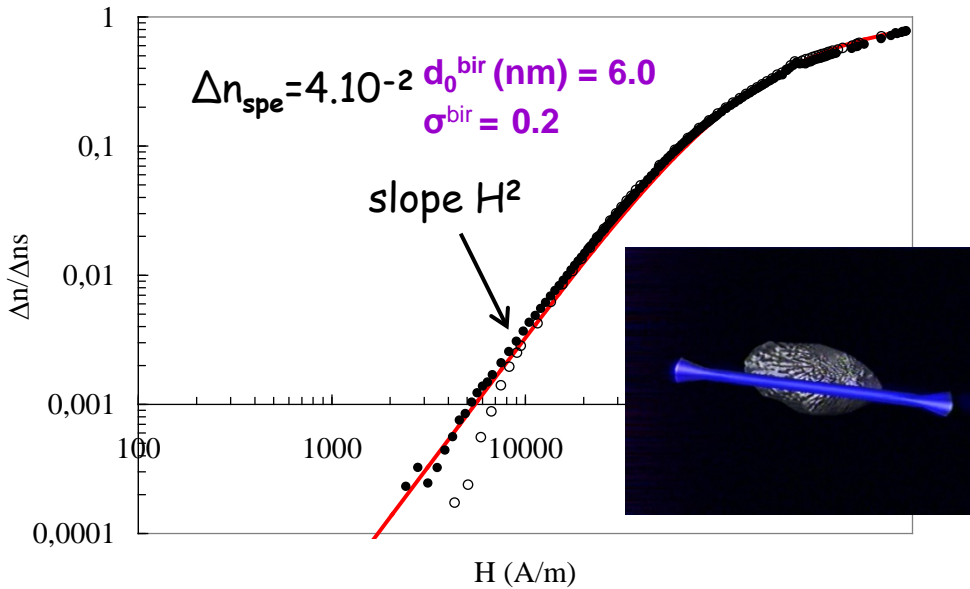

$I_1(\omega) \propto |\sin(\varphi)|$ $I_2(2\omega) \propto (t_{\parallel} - t_{\perp})$ dichroism

$\varphi = 2\pi \Delta n e / \lambda$ $\Delta n = (n_{\parallel} - n_{\perp})$ birefringence

Plateau: $\Delta n_{sat} = \Delta n_{spe} \Phi$

Ferrofluid sample (maghemite $\gamma\text{-Fe}_2\text{O}_3$)

Starting materials : "True" ferrofluid

Ferrofluid = colloidal suspension of magnetic nanoparticles
 which remains stable whatever the intensity of applied magnetic field

- no attraction of nanoparticles under B field gradient nor chaining by dipolar interaction
- but progressive orientation of dipoles according to Langevin's laws:

Magnetization

$m_s = 3,1 \cdot 10^5 \text{ A/m (SI)}$ $m_s / 4\pi = 300 \text{ G (CGS)}$

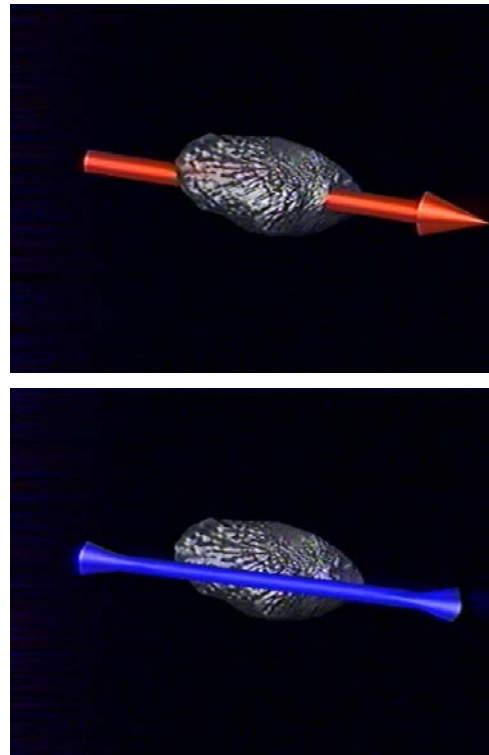
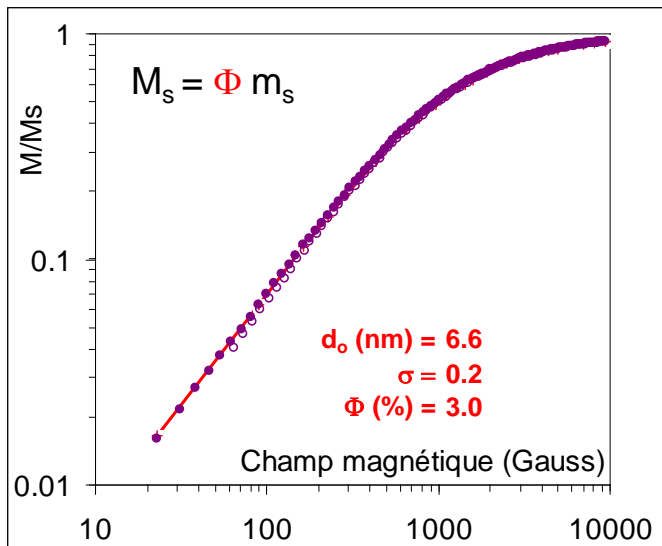

Birefringence

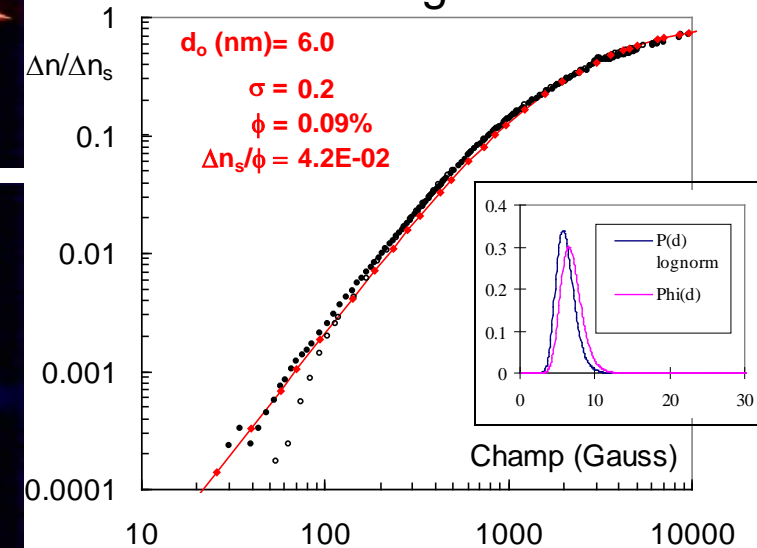

Improved properties of the larger magnetic NPs

Hypethermia:
Robert Müller,
Jena, Germany

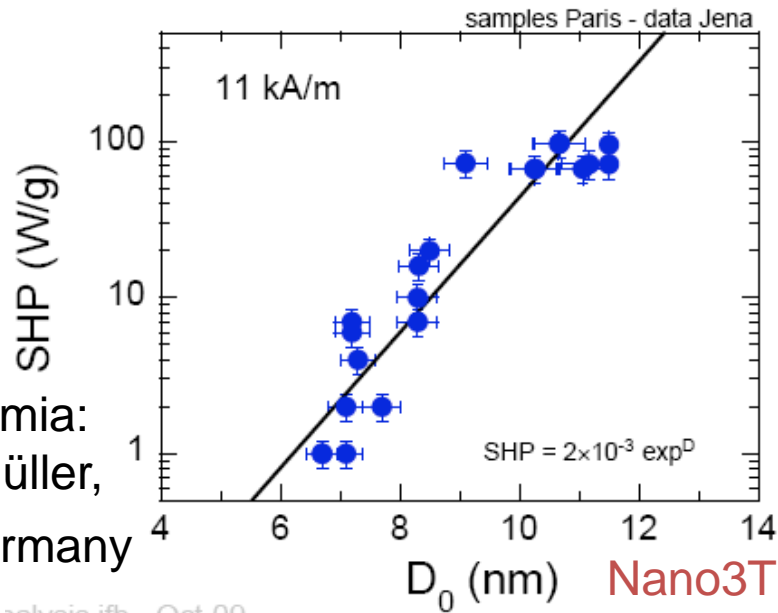

Nano3T 7th PCRD network

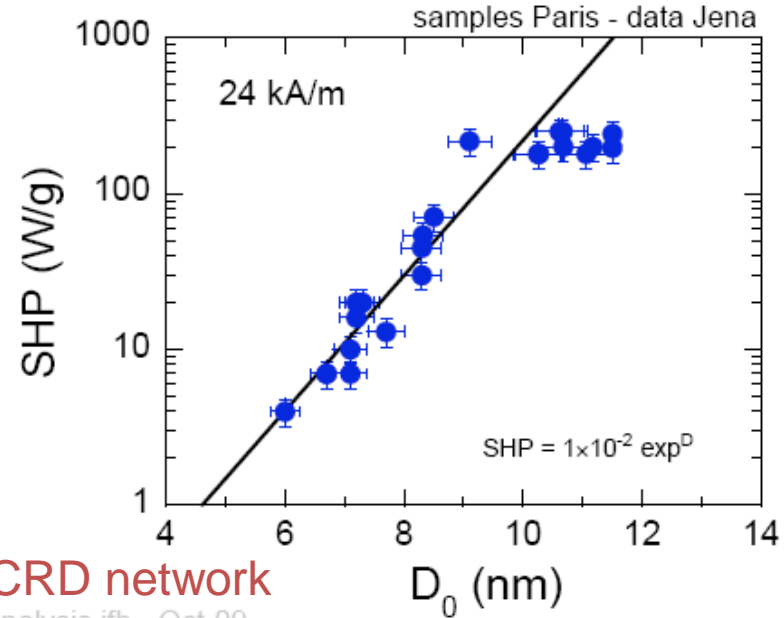

Relaxivities:
Yves Gossuin,
Mons, Belgium

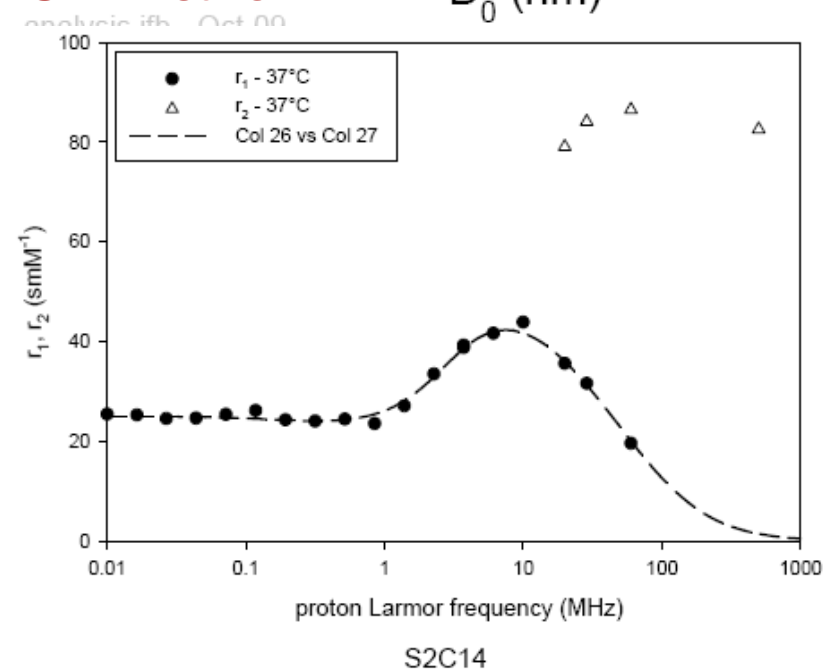
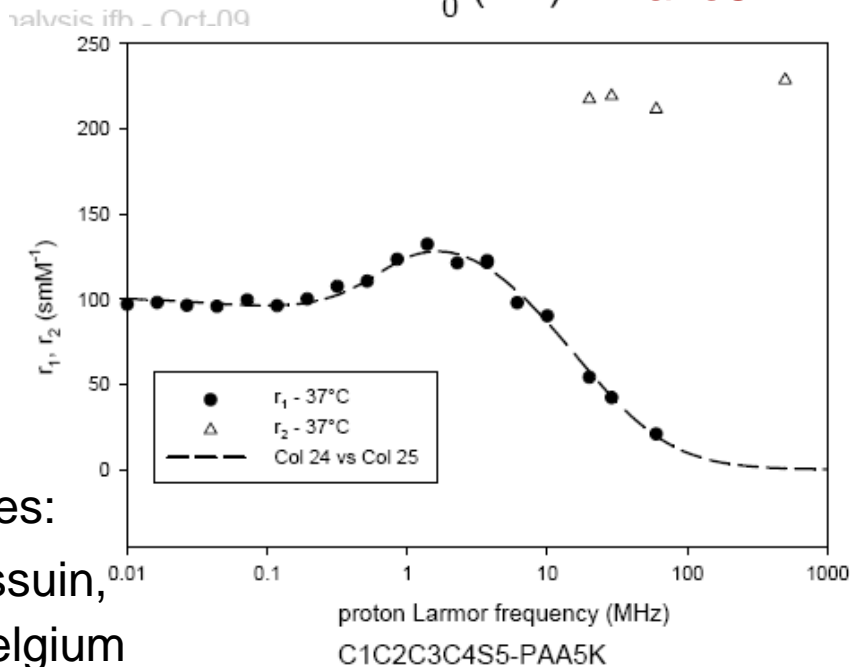

Astalan, A.; Ahrentorp, F.; Jonasson, C.; Blomgren, J.; Yan, M.; Courtois, J.; Berret, J.-F.; Fresnais, J.; Sandre, O.; Müller, R.; Dutz, S.; Johansson, C., AIP Conf. Proc. Series 2010

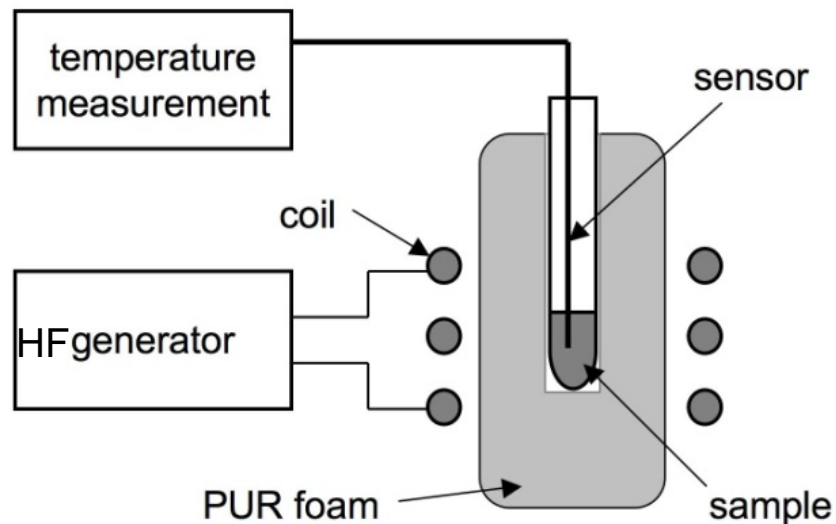
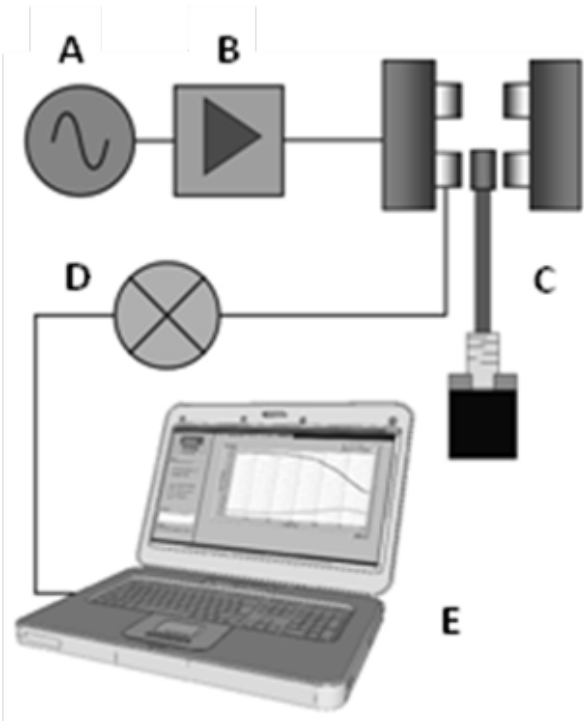

Hyperthermia set-up built by
R. Müller, Jena (Germany)

High frequency AC susceptometer built at
the IMEGO company (Sweden)

AC signal source (A), current amplifier (B),
coil system and mechanics (C), lock-in
amplifier (D) and user interface software (E)

$$SHP = \pi \mu_0 \chi'' f_{RF} H_0^2 V_S$$

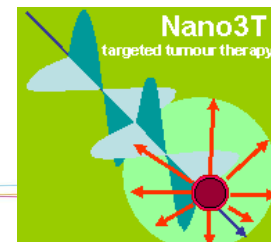

G. Glöckl, R. Hergt, J. Phys.: Condens. Matter 18 (2006) S2935–S2949: resonance effect

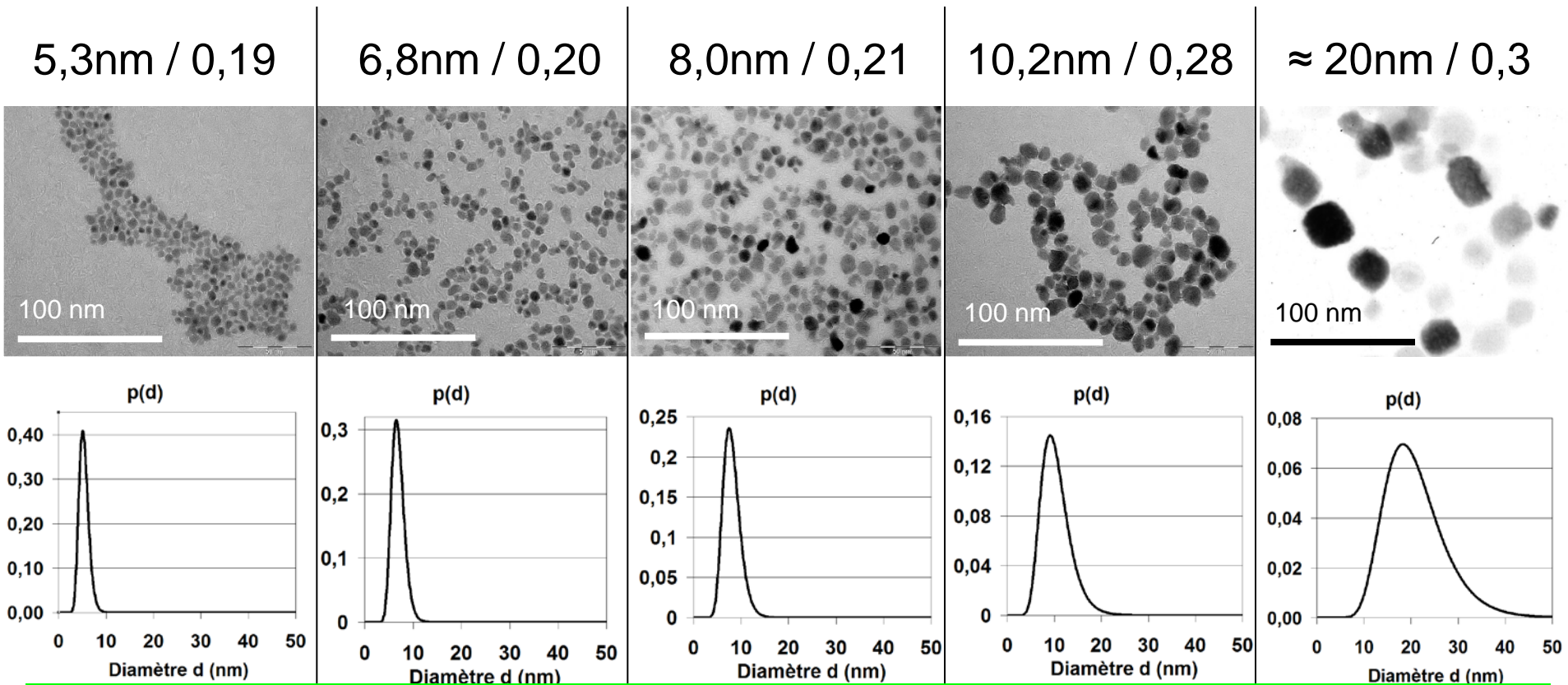

SHP (at $f = 700$ kHz, $H_0 = 24.8$ kAm⁻¹) =

4 W/g

14 W/g

37 W/g

275 W/g

1650 W/g

J-P. Fortin, C. Wilhelm, J. Servais, C. Ménager, J-C. Bacri, F. Gazeau, J. Am. Chem. Soc. 129 2628 (2007)

M. Lévy, C. Wilhelm, J-M. Siaugue, O. Horner, J-C. Bacri, F. Gazeau, J. Phys. Cond. Mat. 20 204133 (2008)

Calibration sample: monodisperse Fe_3O_4 nano-spheres

Astalan, A.; Ahrentorp, F.; Jonasson, C.; Blomgren, J.; Yan, M.; Courtois, J.; Berret, J.-F.; Fresnais, J.; Sandre, O.; Müller, R.; Dutz, S.; Johansson, C., AIP Conf. Proc. Series 2010

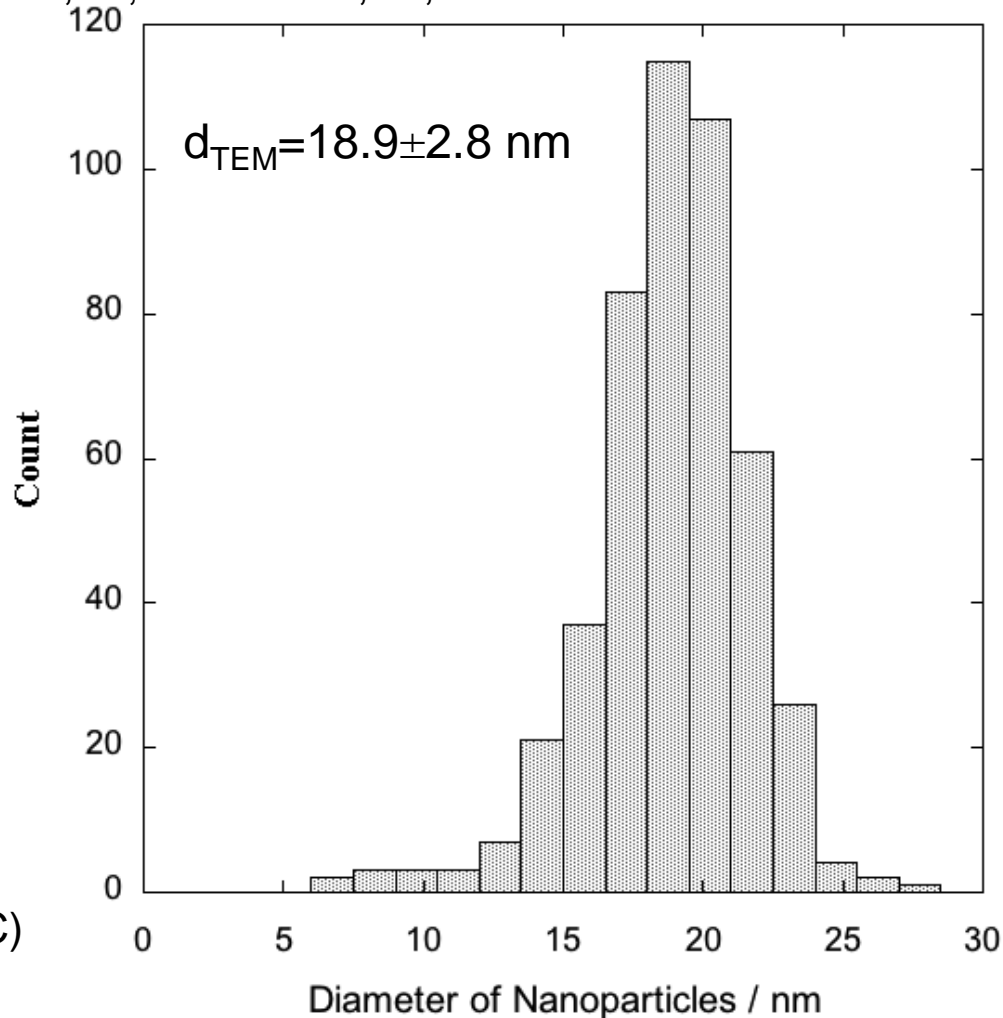
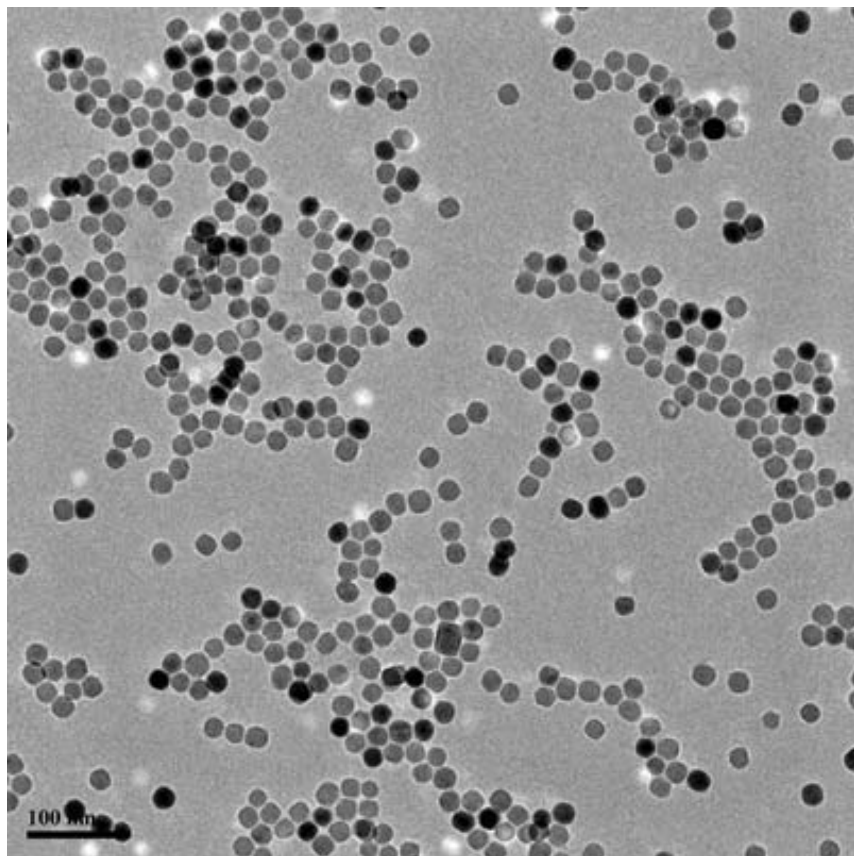

Fe-oleate decomposition in n-hexane (4h 70°C)
Q. Bin, O. T. Mefford (Clemson Univ, USA)
according to Park et al, Angew. Ch. 2005)

Role of MNP shape on the magnetic anisotropy K_a

Astalan, A.; Ahrentorp, F.; Jonasson, C.; Blomgren, J.; Yan, M.; Courtois, J.; Berret, J.-F.; Fresnais, J.; Sandre, O.; Müller, R.; Dutz, S.; Johansson, C., AIP Conf. Proc. Series 2010

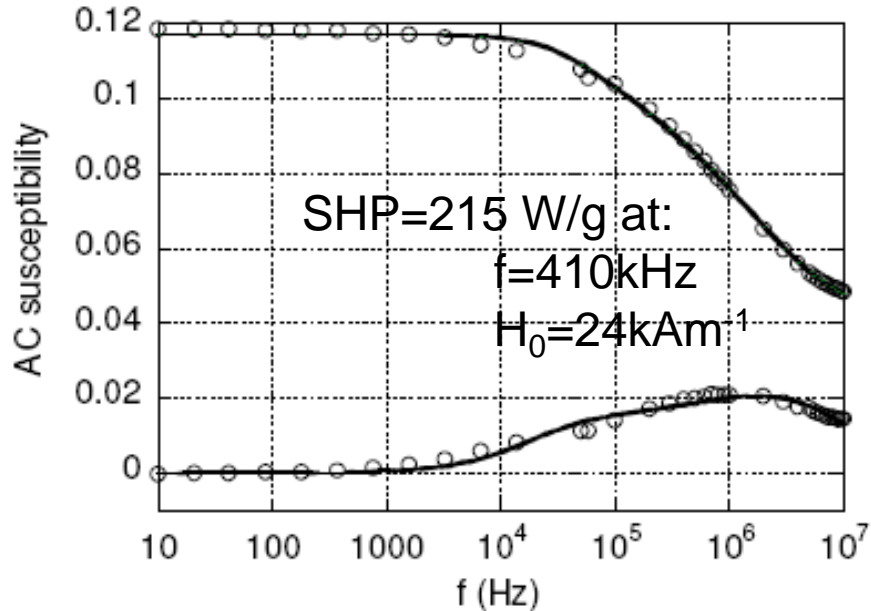

rock-like particles $\text{\O}16\text{nm}$:
large χ'' , Néel's band $\sim 2\text{MHz}$

$$\chi(\omega) = C \int \frac{r_c^6}{(1 + j\omega\tau_{\text{eff}}(r_H))} f(r_H) dr_H + \chi_{\text{high}}$$

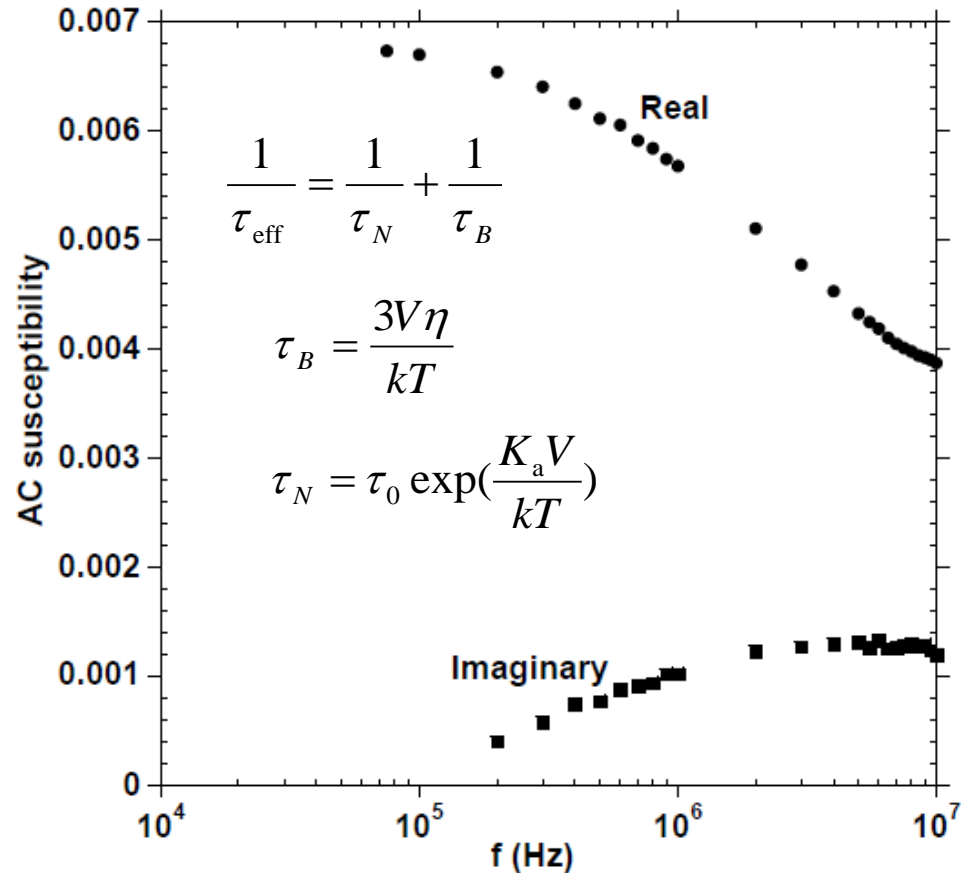

spheres $\text{\O}19\text{nm}$: weak χ'' , Néel's band $\sim 5\text{MHz}$

Improved properties of the larger magnetic NPs

Hypethermia:
Robert Müller,
Jena, Germany

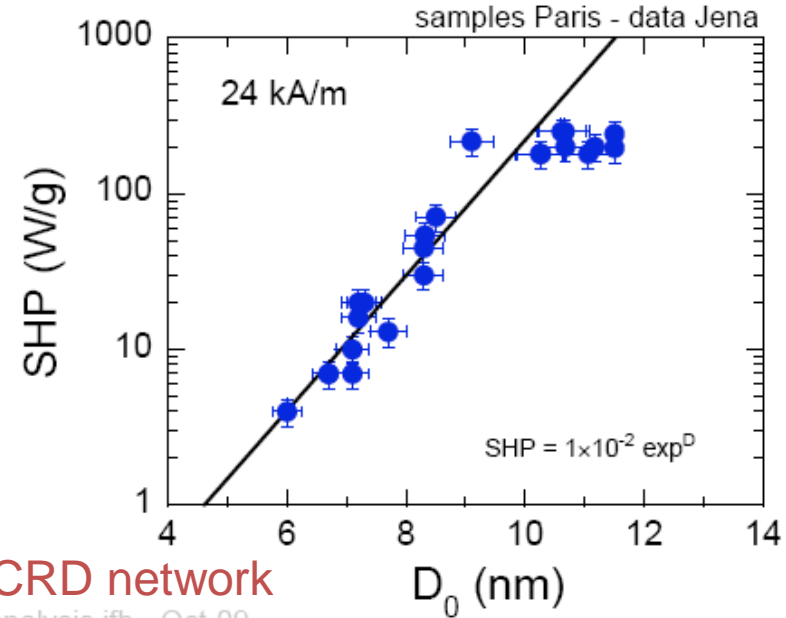
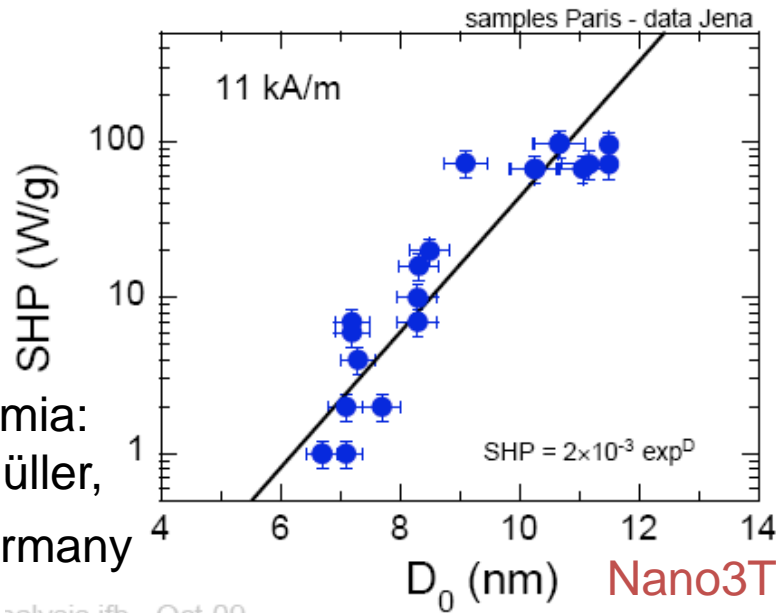

Nano3T 7th PCRD network

Relaxivities:
Yves Gossuin,
Mons, Belgium

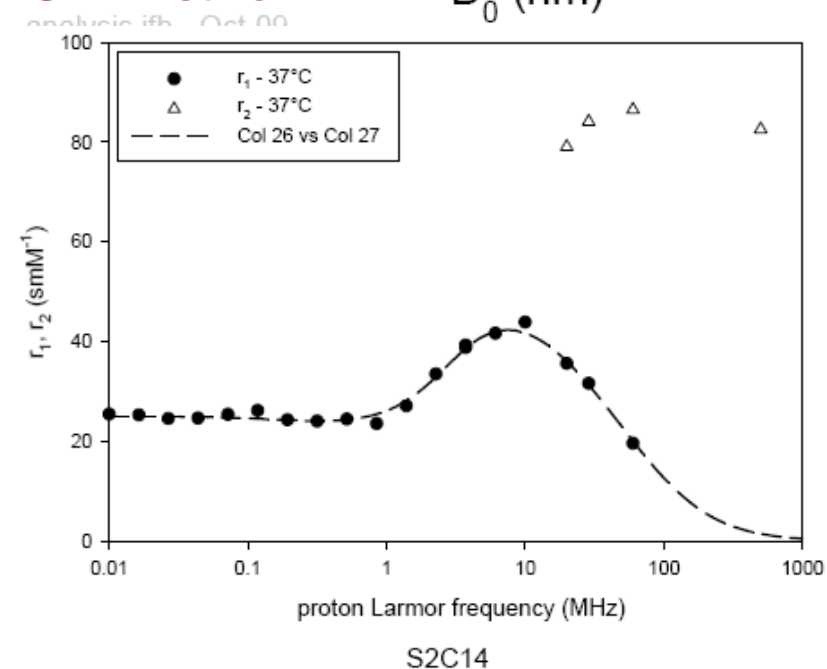
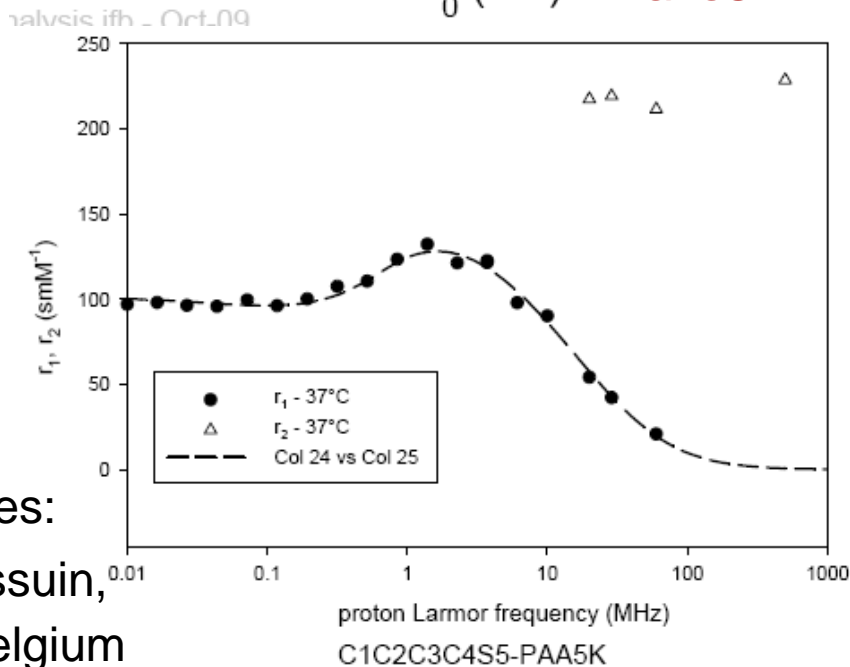

Ionic Ferrofluids: the coprecipitation synthesis

- Massart's process:
Alkaline coprecipitation of FeCl_2 & FeCl_3
→ magnetite Fe_3O_4 nanoparticles

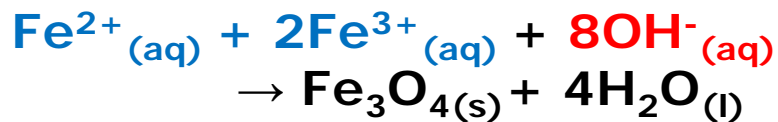

R. Massart *IEEE Trans. Magn.* **17** 1247 (1981)

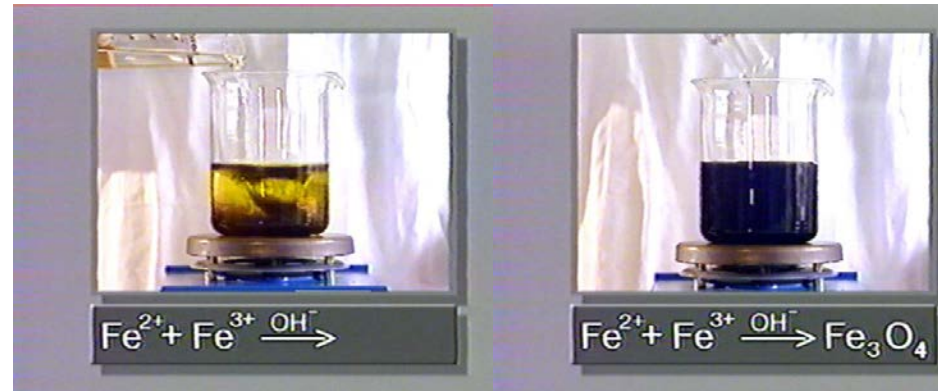

- Oxidation by $\text{Fe}(\text{NO}_3)_3$
→ maghemite $\gamma\text{-Fe}_2\text{O}_3$ nanoparticles
in acidic medium (HNO_3): stabilized by
electrostatic surface charges ($\text{PZC} \approx 7$)

A. Abou-Hassan, O. Sandre, and V. Cabuil, *Chapter 9: Microfluidics for the synthesis of iron oxide nanoparticles, in Microfluidic Devices in Nanotechnology: Applications*, C.S.S.R. Kumar, Editor. **2010**, John Wiley & Sons, Inc: Hoboken, NJ, USA. p. 323-360

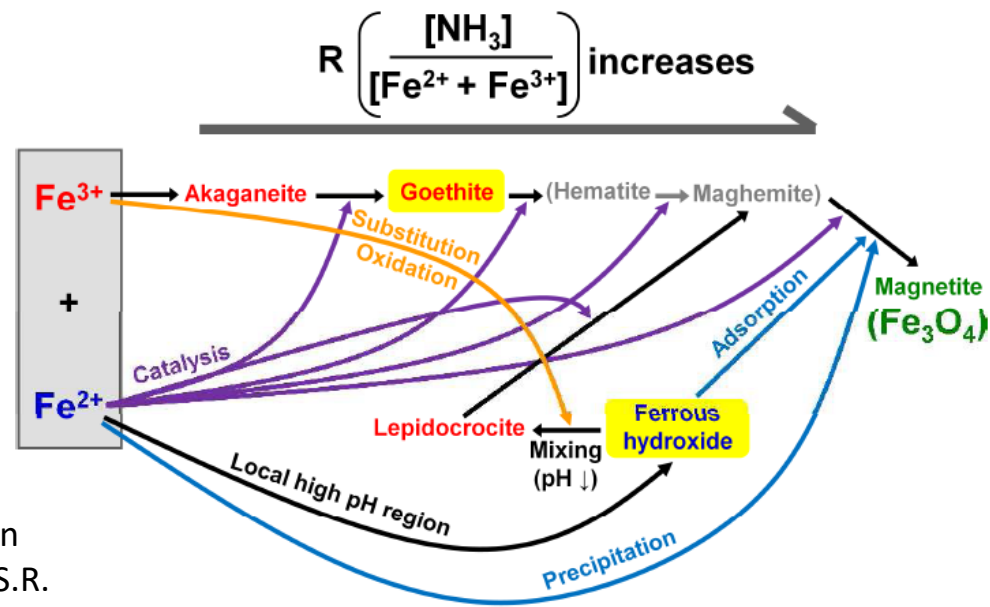

T. Ahm et al. *J. Phys. Chem.* (2012) pre-print

Microfluidics as a tool to get an insight of the kinetics of the coprecipitation reaction

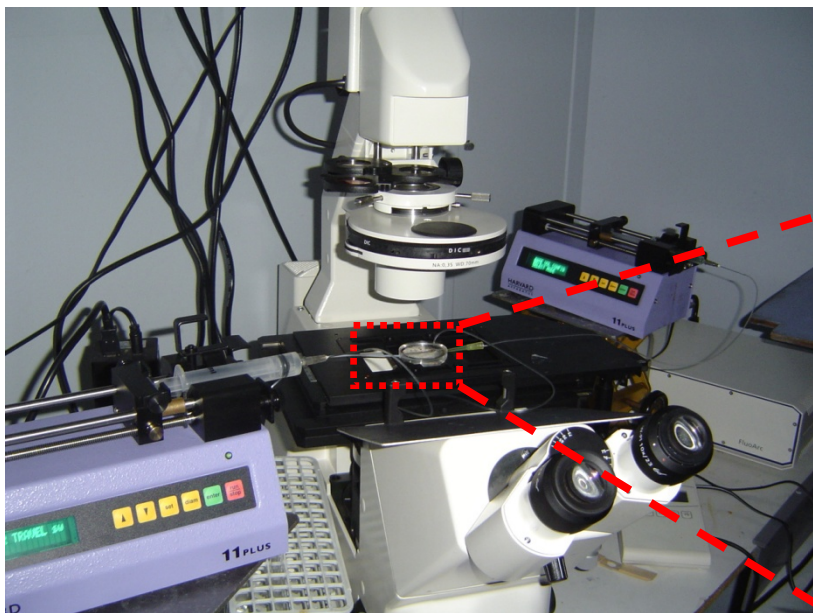
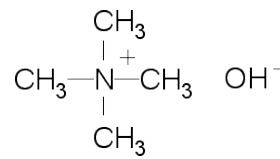

Answer to clogging issue: 3D geometry and non flocculating counterion of base TMA⁺

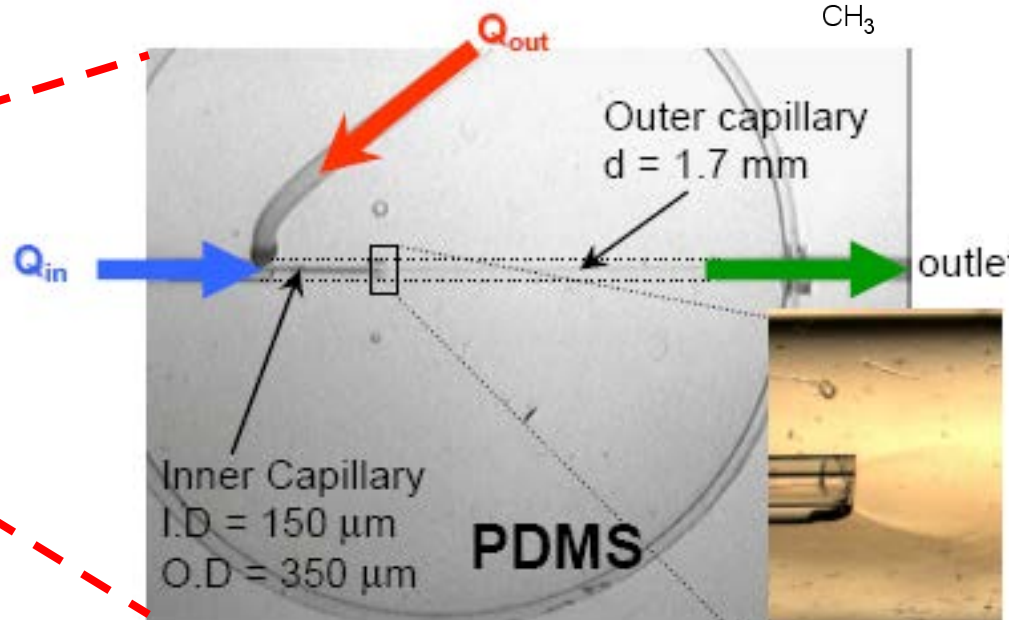

PhD thesis Ali Abou Hassan (2 oct 2009)

A. Abou Hassan, O. Sandre, V. Cabuil, P. Tabeling, *Chem. Commun.* 2008, 1783

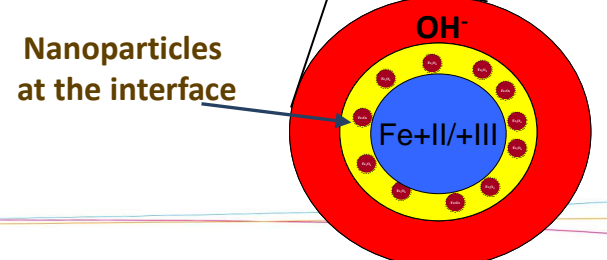
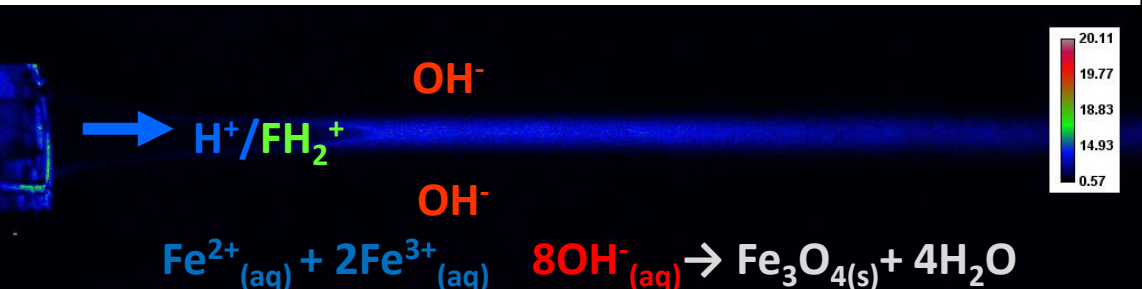

Microfluidics as a tool to get an insight of the mechanism of goethite formation

Two micro-reactors in-line

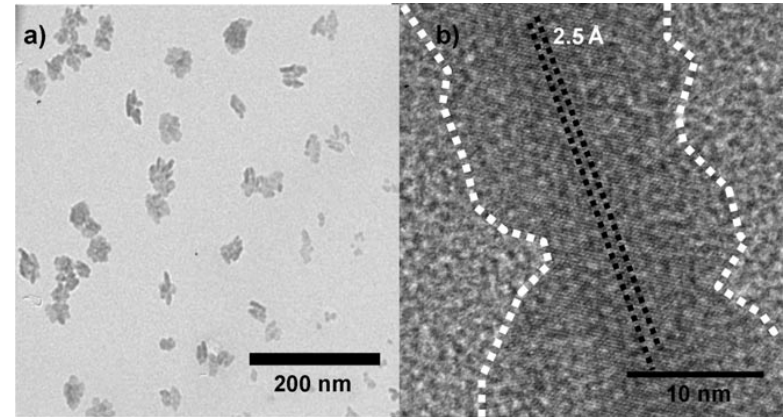
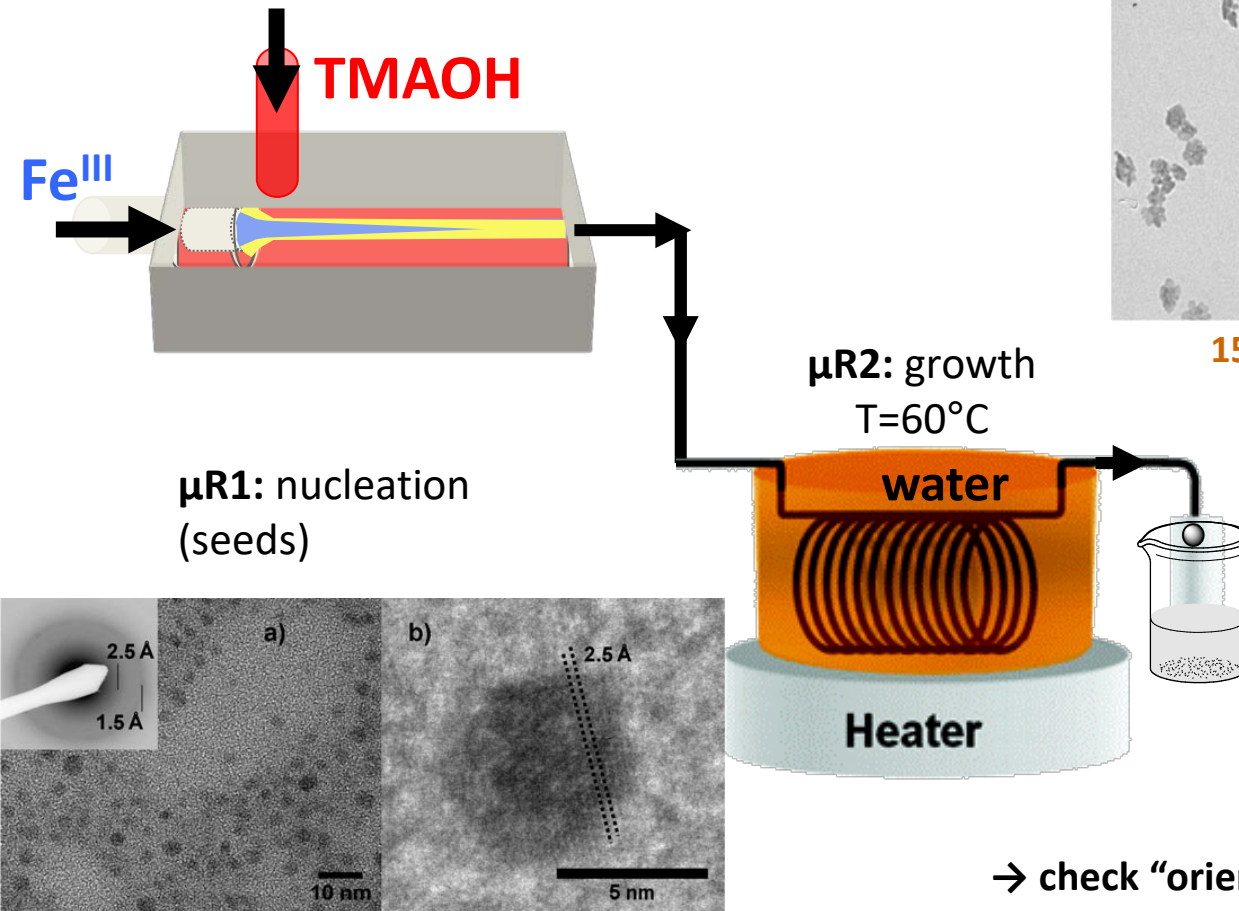

15 min / 60°C: Goethite nanorods
L=30±17 nm and w=7±4 nm

Final state as in macro synthesis

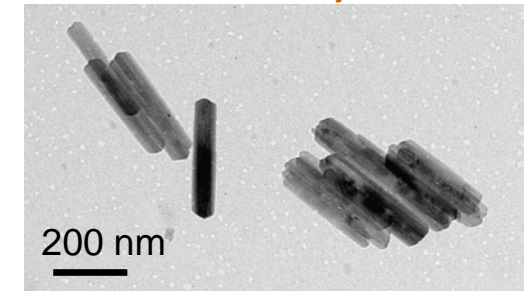

→ check “oriented aggregation” mechanism

J. F. Banfield et al. *Science* 2000, 289, 751

“2-lines ferrihydrite” nanodots $\varnothing = 4 \pm 1$ nm

A. Abou-Hassan, O. Sandre, S. Neveu, V. Cabuil, *Angew. Ch.* **48** 1-5 (2009)

Microfluidics as a tool to get an insight of the mechanism of goethite formation

▪ FEM lab simulations

$$\frac{\partial C_i}{\partial t} + \text{div}(C_i \mathbf{u} + \mathbf{j}_i) = \sigma_i$$

$$\mathbf{j}_i = -D_i \text{grad} C_i + \frac{D_i}{k_B T} C_i Z_i e \mathbf{E} \quad (\text{Nernst-Planck})$$

▪ Confocal Laser Scanning Microscopy: Fluorescein as pH reporter dye

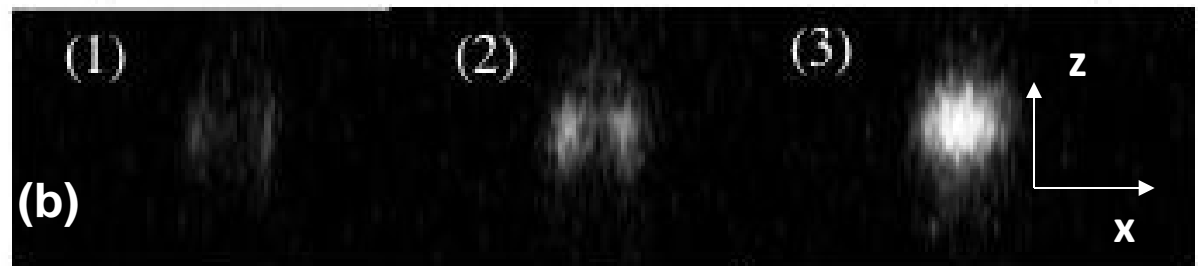
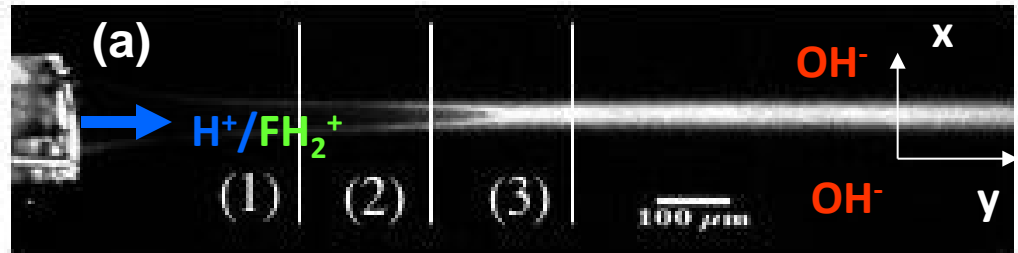
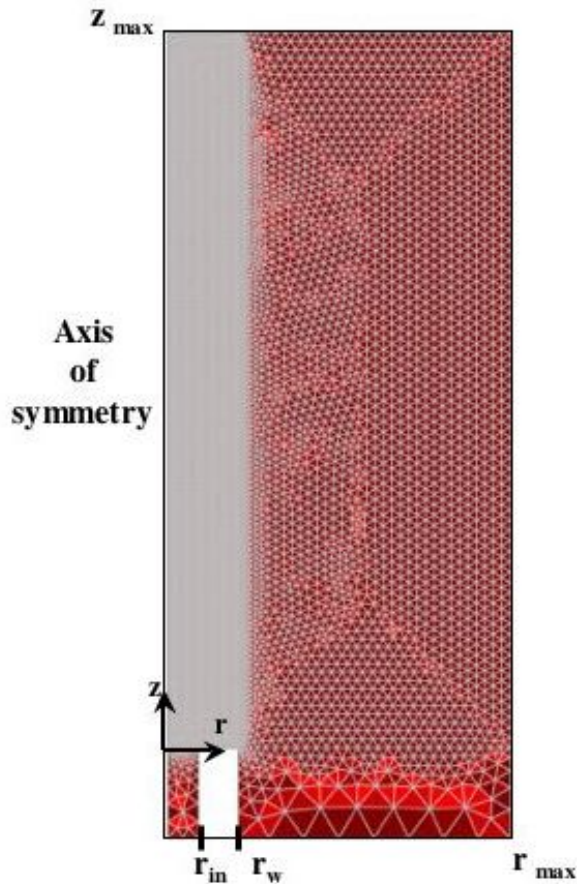

$$\text{pH} = f(\alpha) \text{ with } \alpha = Q_{\text{OH}^-} / Q_{\text{H}^+}$$

A. Abou-Hassan, J-F. Duf r che, O. Sandre, G. M riguet, O. Bernard, V. Cabuil, *J. Chem. Phys. C* 2009

Microfluidics as a tool to get an insight of the mechanism of goethite formation

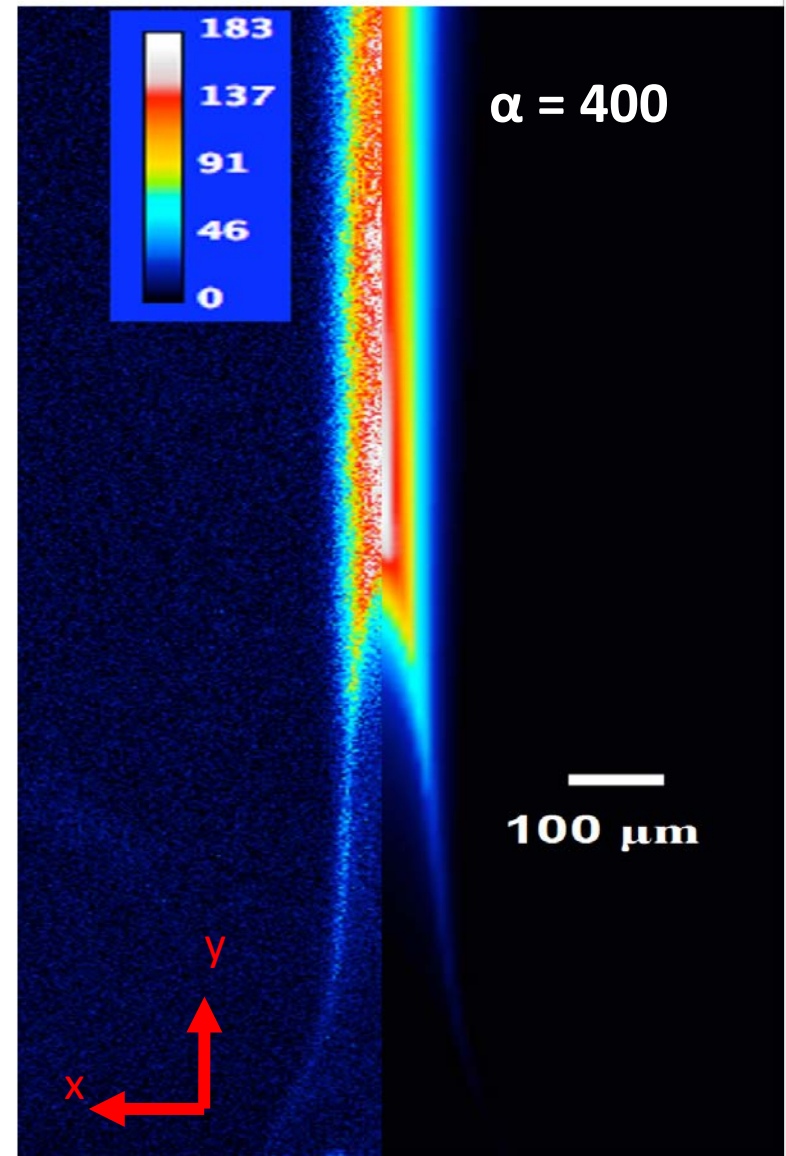
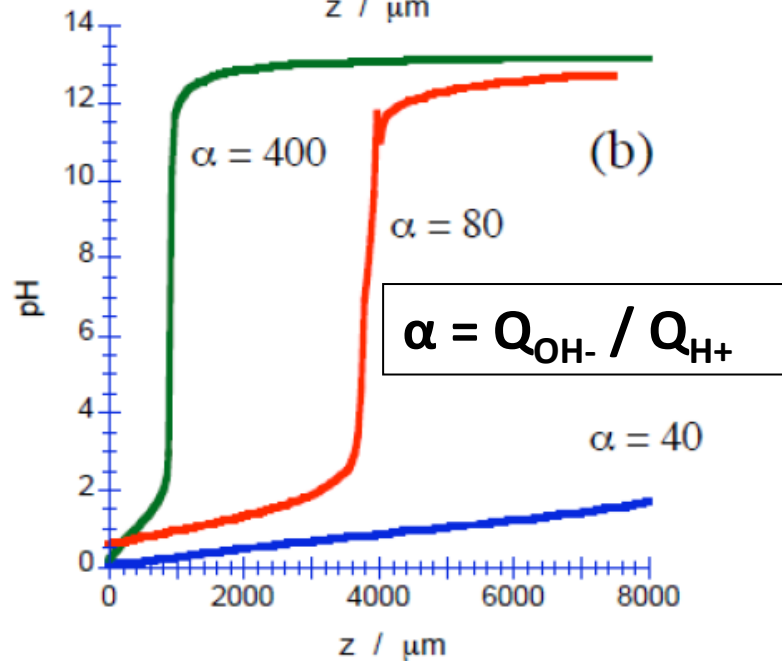
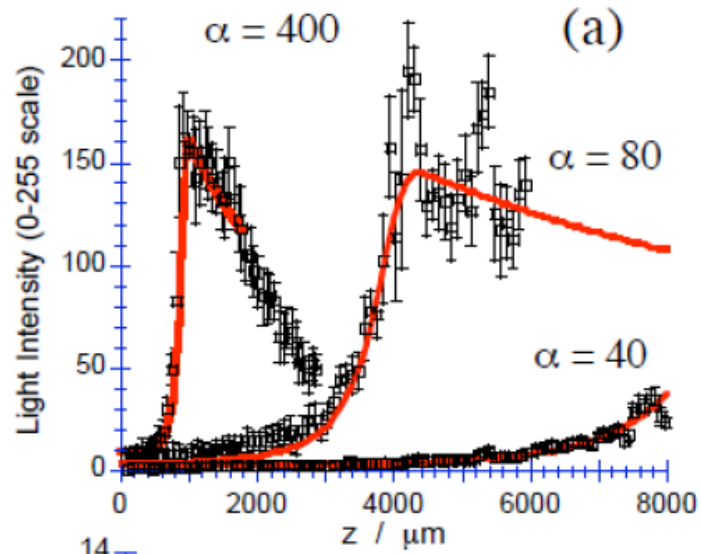

Detection of first seeds using SAXS in microfluidics

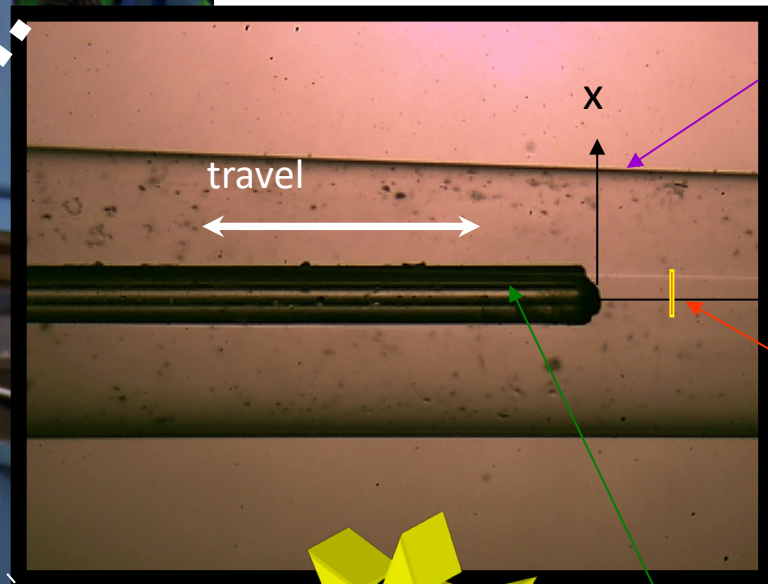
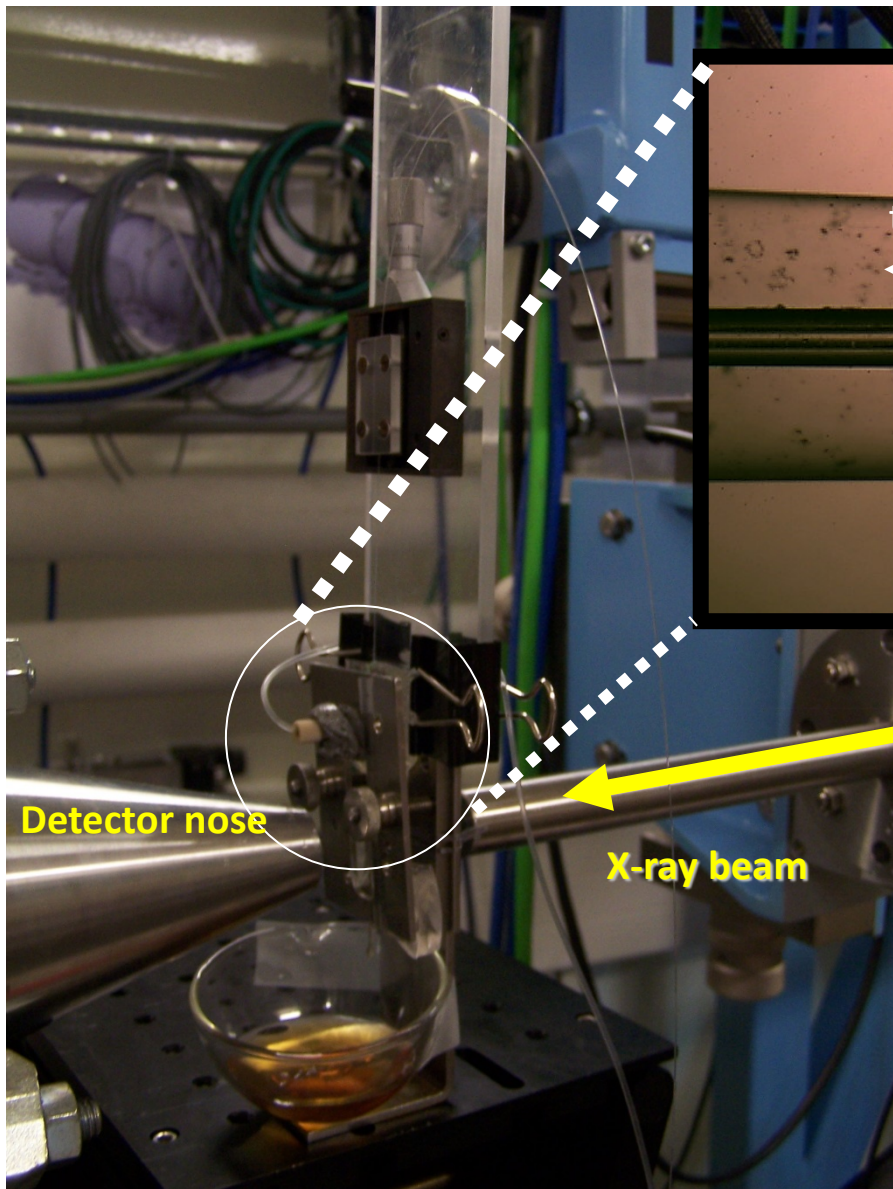

Lindemann
glass capillary
 $\varnothing = 1,6 \text{ mm}$
(wall thickness
 $= 10 \mu\text{m}$)

beam $300 \times 100 \mu\text{m}$
cross-section at fixed
position

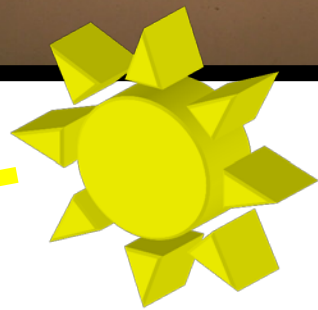

Internal capillary
 $\varnothing_{\text{int}} = 100 \mu\text{m}$
 $\varnothing_{\text{ext}} = 350 \mu\text{m}$

SAXS measurements on SWING line at
SOLEIL synchrotron (July 2009)



Abou Hassan, O. Sandre,
V. Dupuis, Olivier Spalla

Preliminary SAXS results: intensity curves along z

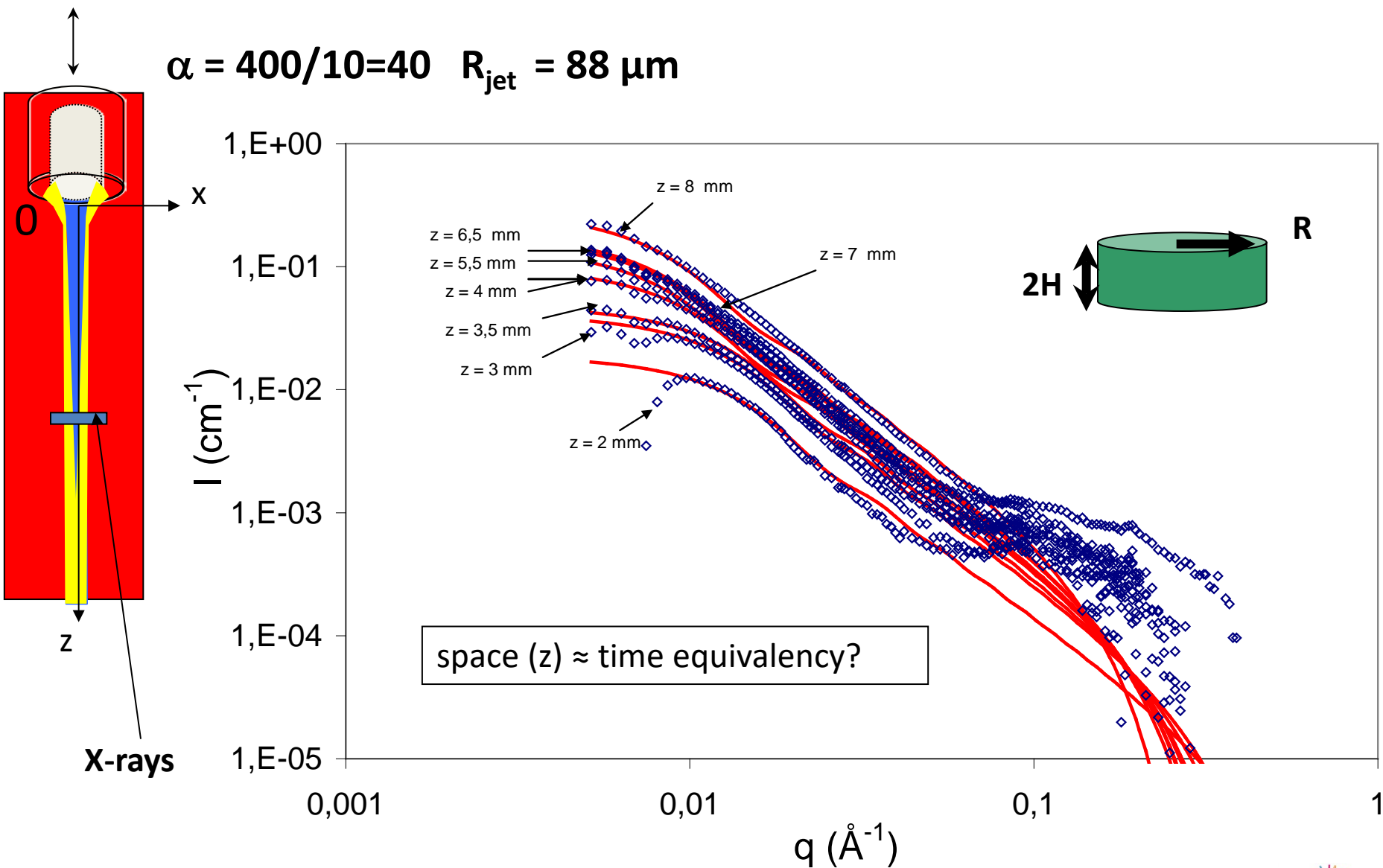

Preliminary SAXS results: fits as disk form factor

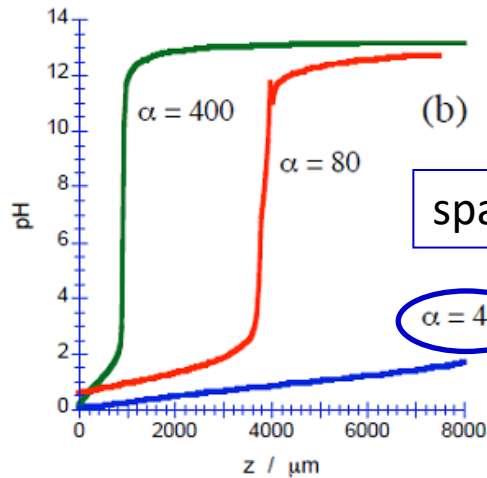

space (z) \approx pH equivalency

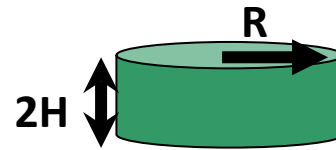

Anisotropy R/H

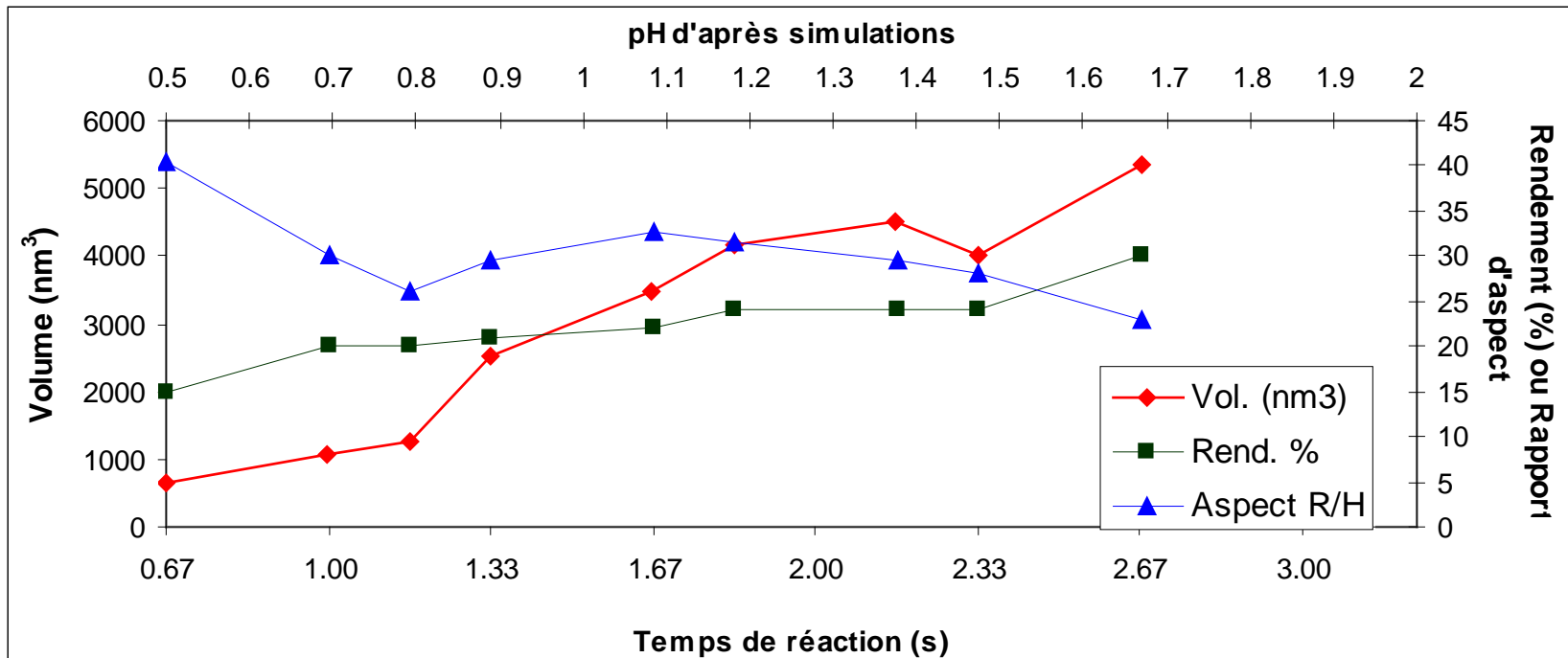

Preliminary SAXS results: fits as disk form factor

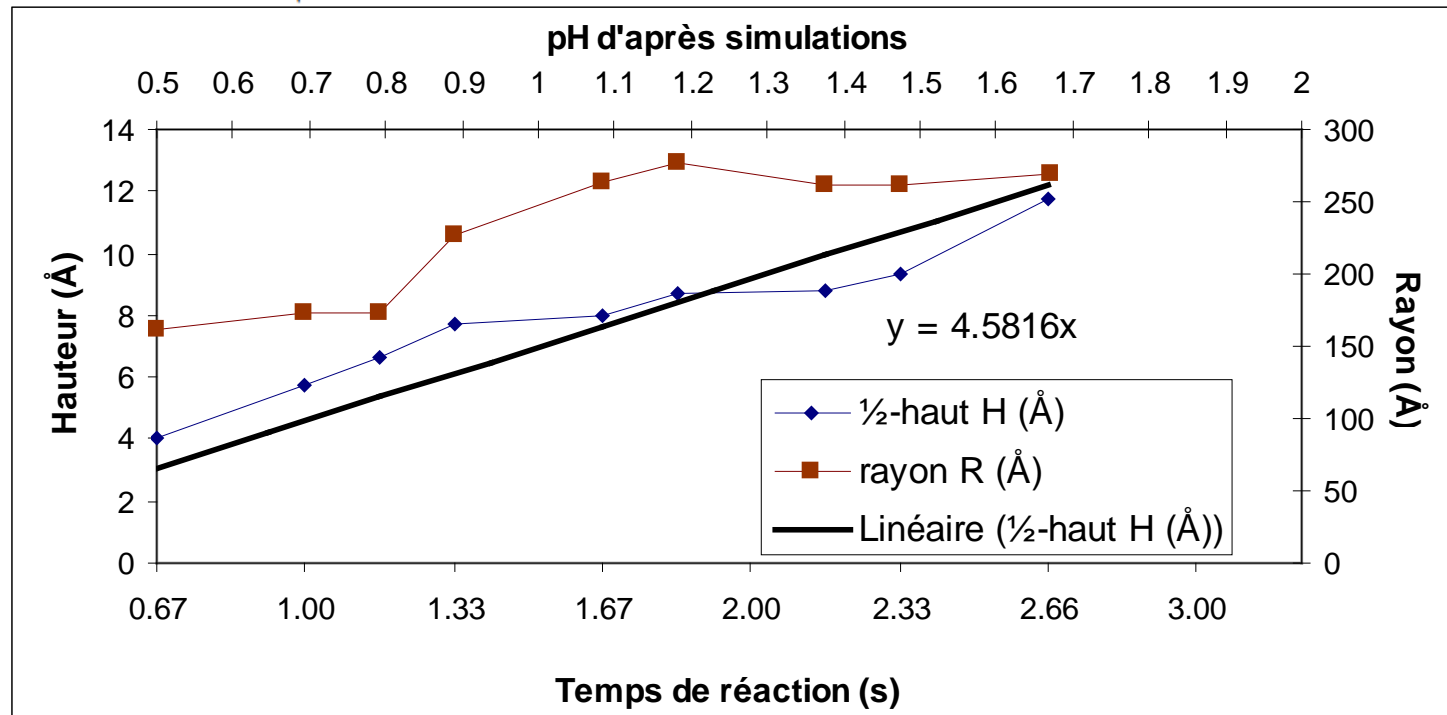
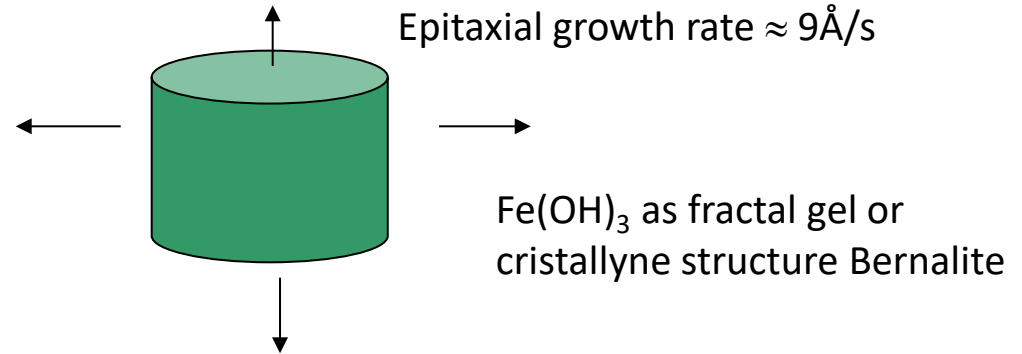
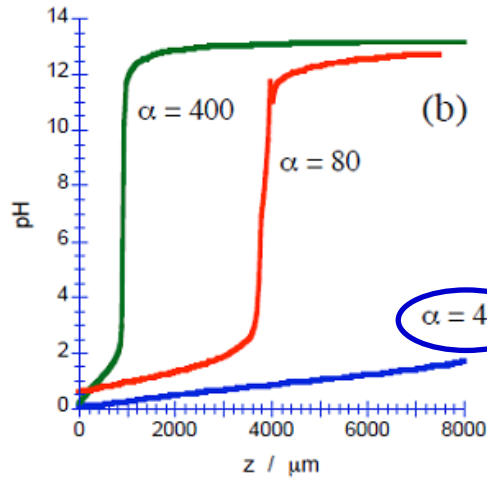

Coatings of iron oxide and oxo-hydroxide NPs for their dispersion in various media

Different coatings to insure colloidal stability :

- surfactants (oleic acid, phosphoric di-ester, ...) for organic solvents (alkanes, chlorinated,...)

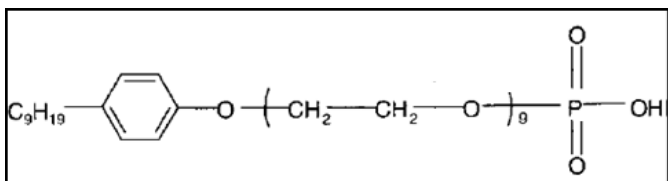

- sodium citrate in aqueous neutral medium (pH=7.2) or sodium polyacrylate (2000 or 5000 g/mol)

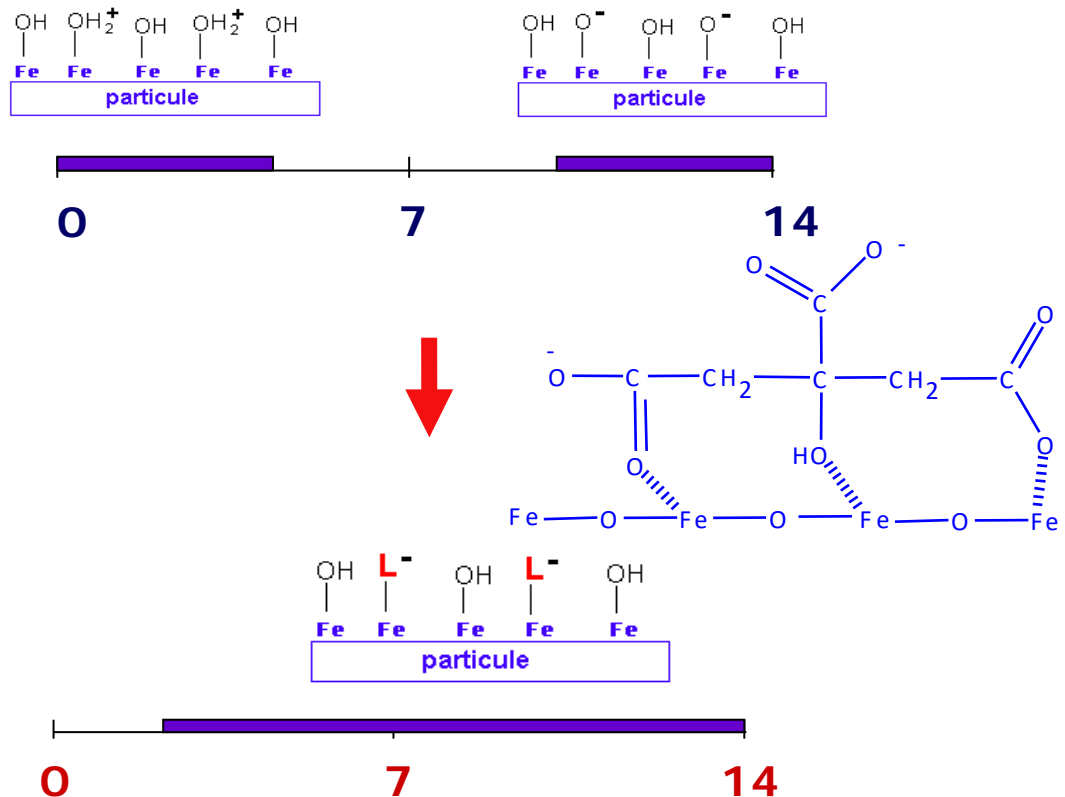
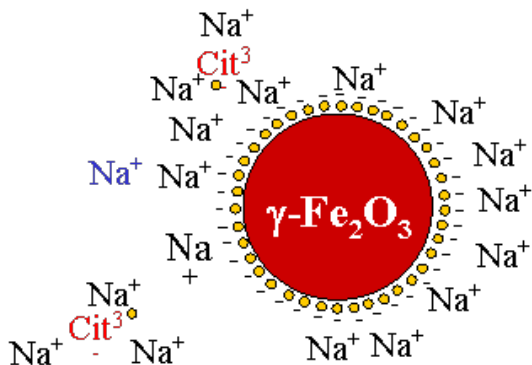

20 mol%/Fe addition precipitation-redispersion

J. A. Galicia, O. Sandre, F. Cousin, D. Guemghar, C. Ménager, V. Cabuil, *J. Phys.-Cond. Mat.* **2003**, 15 S1379.

Ionic Ferrofluids: demixtion & size sorting

Size Polydispersity: $P(d, \text{nm})$

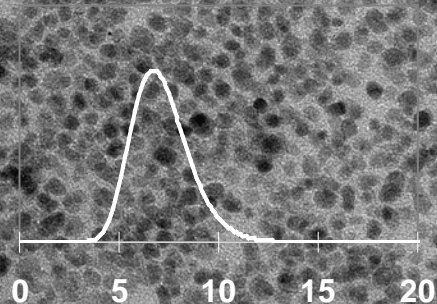

Fractionated separations

50 nm

R. Massart, E. Dubois, V. Cabuil, E. Hasmonay, J. Magn. Mater. 149 1 (1995)

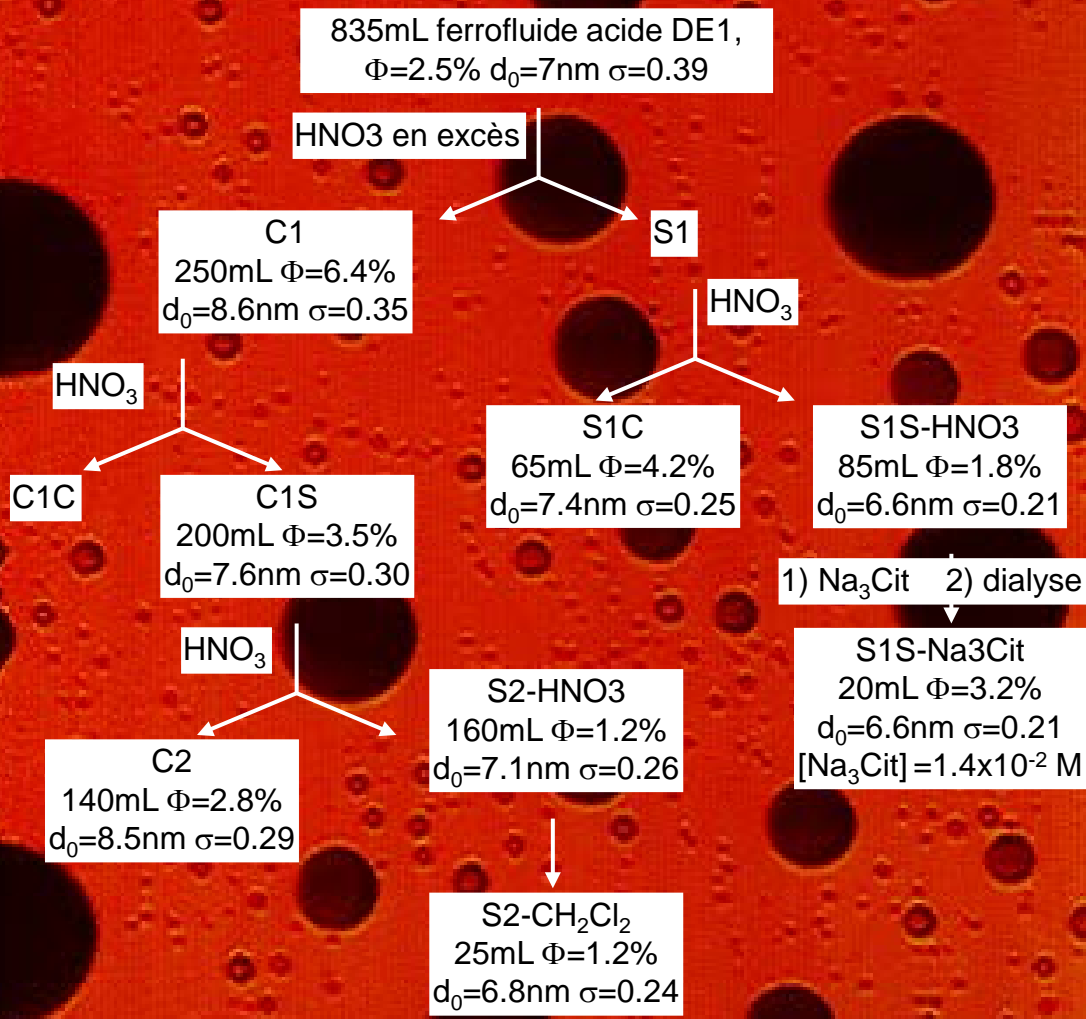
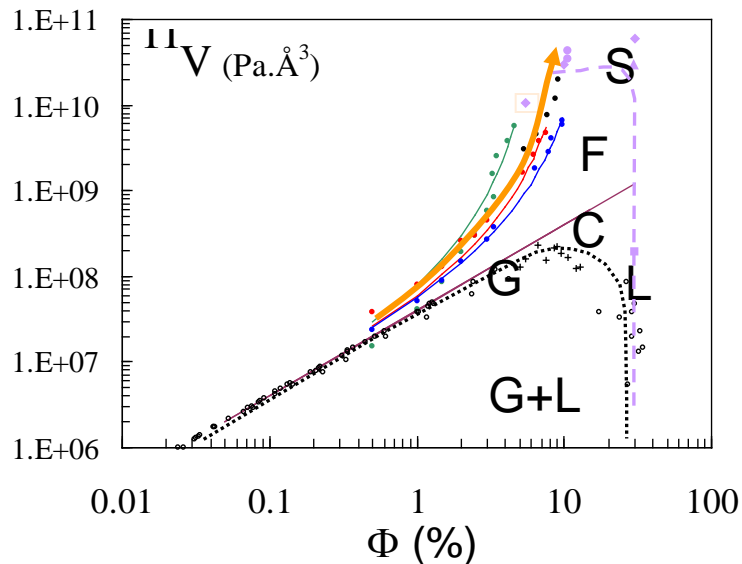

Size-sorted "ionic ferrofluid" as elementary bricks

USPIO fraction	Given name in this work	D_H of bare MNPs in HNO_3 nm / PDI	Average diameters by TEM	Average diameters by VSM	Saturation magnetization emu/g A/m	r_2 (4.7T) $s^{-1}mM^{-1}Fe_e$	SLP at $f=800$ kHz, $H_0=11$ kA/m W/g
S1S2S3	6-7 nm	11 / 0.12	$d_n=4.9$ nm, $d_w=6.9$ nm ($N=600$)	$d_n=6.5$ nm, $d_w=7.5$ nm	55 ± 1 2.8×10^5	70	2 ± 1

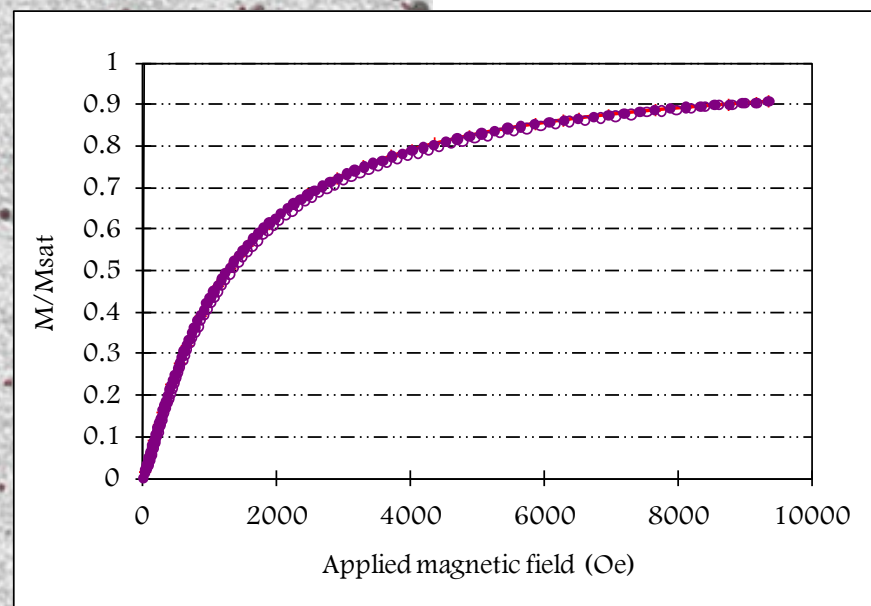
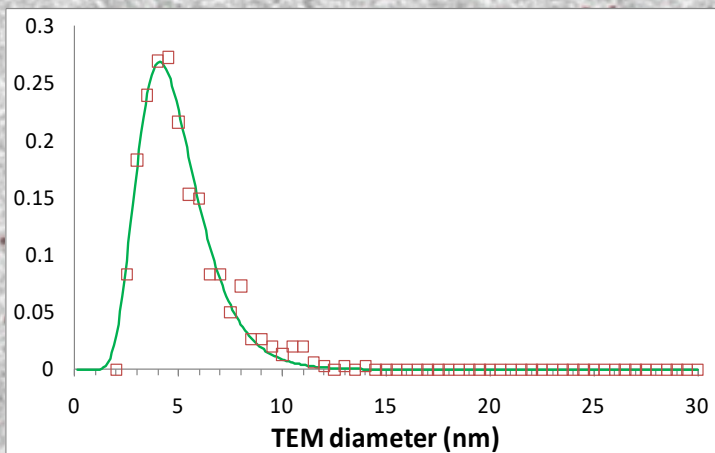

Size-sorted "ionic ferrofluid" as elementary bricks

USPIO fraction	Given name in this work	D_H of bare MNPs in HNO_3 nm / PDI	Average diameters by TEM	Average diameters by VSM	Saturation magnetization emu/g A/m	r_2 (4.7T) $s^{-1}mM^{-1}Fe_e$	SLP at $f=800$ kHz, $H_0=11$ kA/m W/g
S1S2S3	6-7 nm	11 / 0.12	$d_n=4.9$ nm, $d_w=6.9$ nm ($N=600$)	$d_n=6.5$ nm, $d_w=7.5$ nm	55 ± 1 2.8×10^5	70	2 ± 1
S1C2	8-10 nm	23 / 0.16	$d_n=8.5$ nm, $d_w=11.6$ nm ($N=3800$)	$d_n=8.2$ nm, $d_w=10.0$ nm	60 3.0×10^5	104	9 ± 1

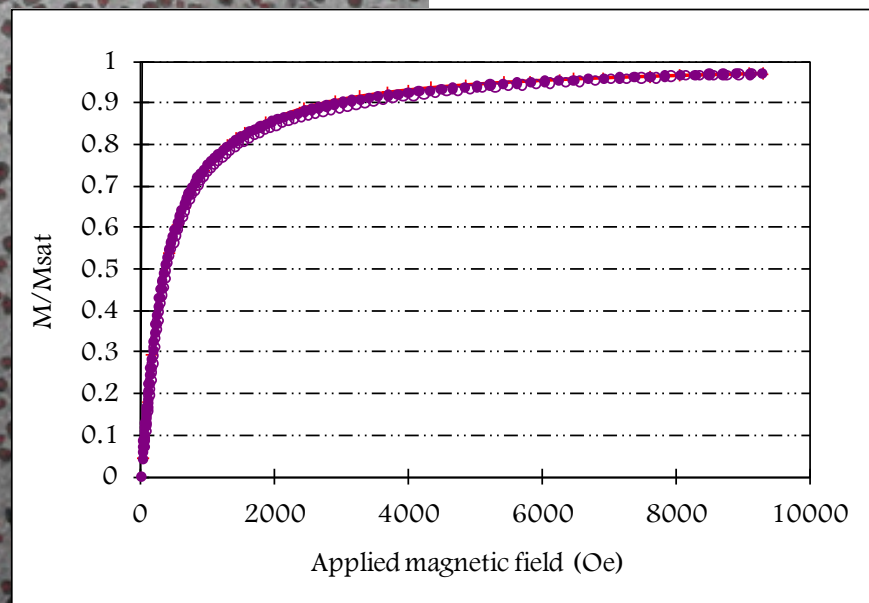
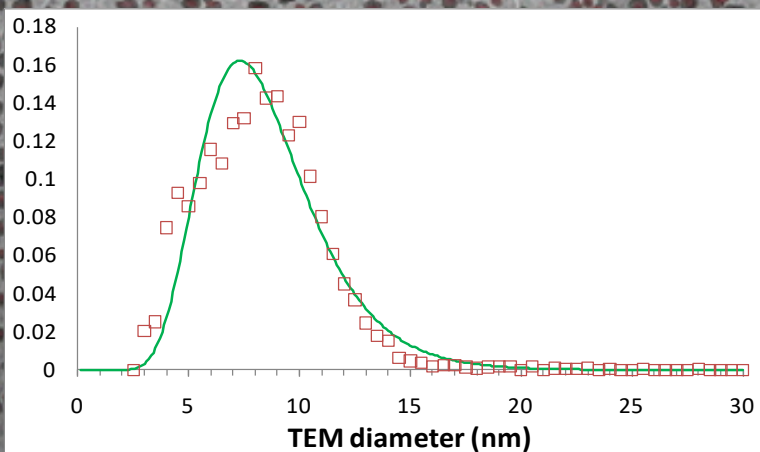

Size-sorted "ionic ferrofluid" as elementary bricks

USPIO fraction	Given name in this work	D_H of bare MNPs in HNO_3 nm / PDI	Average diameters by TEM	Average diameters by VSM	Saturation magnetization emu/g A/m	r_2 (4.7T) $s^{-1}mM^{-1}Fe_e$	SLP at $f=800$ kHz, $H_0=11$ kA/m W/g
S1S2S3	6-7 nm	11 / 0.12	$d_n=4.9$ nm, $d_w=6.9$ nm ($N=600$)	$d_n=6.5$ nm, $d_w=7.5$ nm	55 ± 1 2.8×10^5	70	2 ± 1
S1C2	8-10 nm	23 / 0.16	$d_n=8.5$ nm, $d_w=11.6$ nm ($N=3800$)	$d_n=8.2$ nm, $d_w=10.0$ nm	60 3.0×10^5	104	9 ± 1
C1C2S3S4	10-15 nm	38 / 0.26	$d_n=13.8$ nm, $d_w=20$ nm ($N=1140$)	$d_n=10.4$ nm, $d_w=14.8$ nm	70 ± 1 3.5×10^5	293	80 ± 5

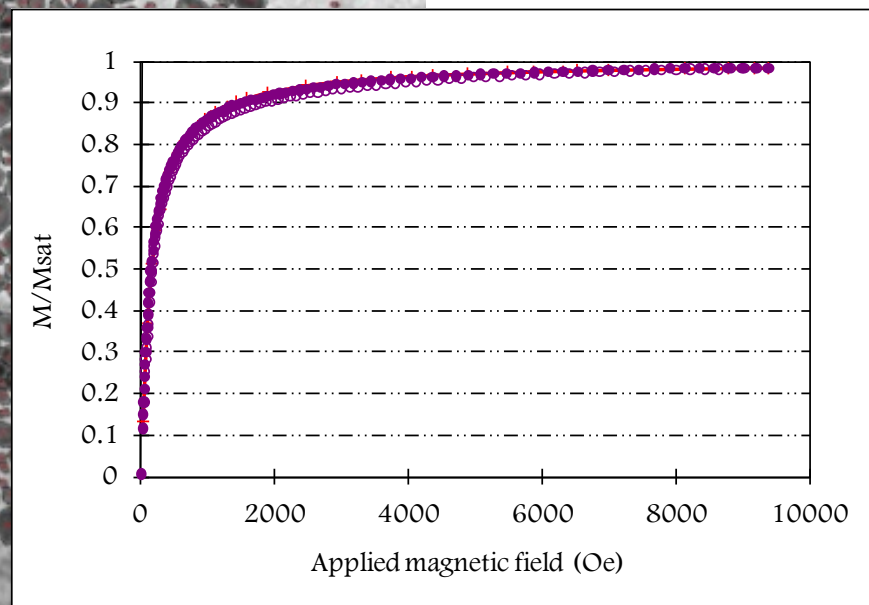
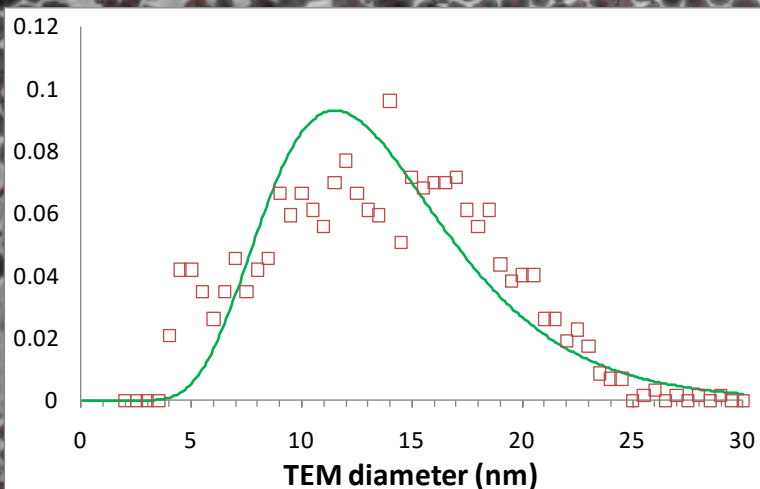

Magnetization curves along the size-grading process

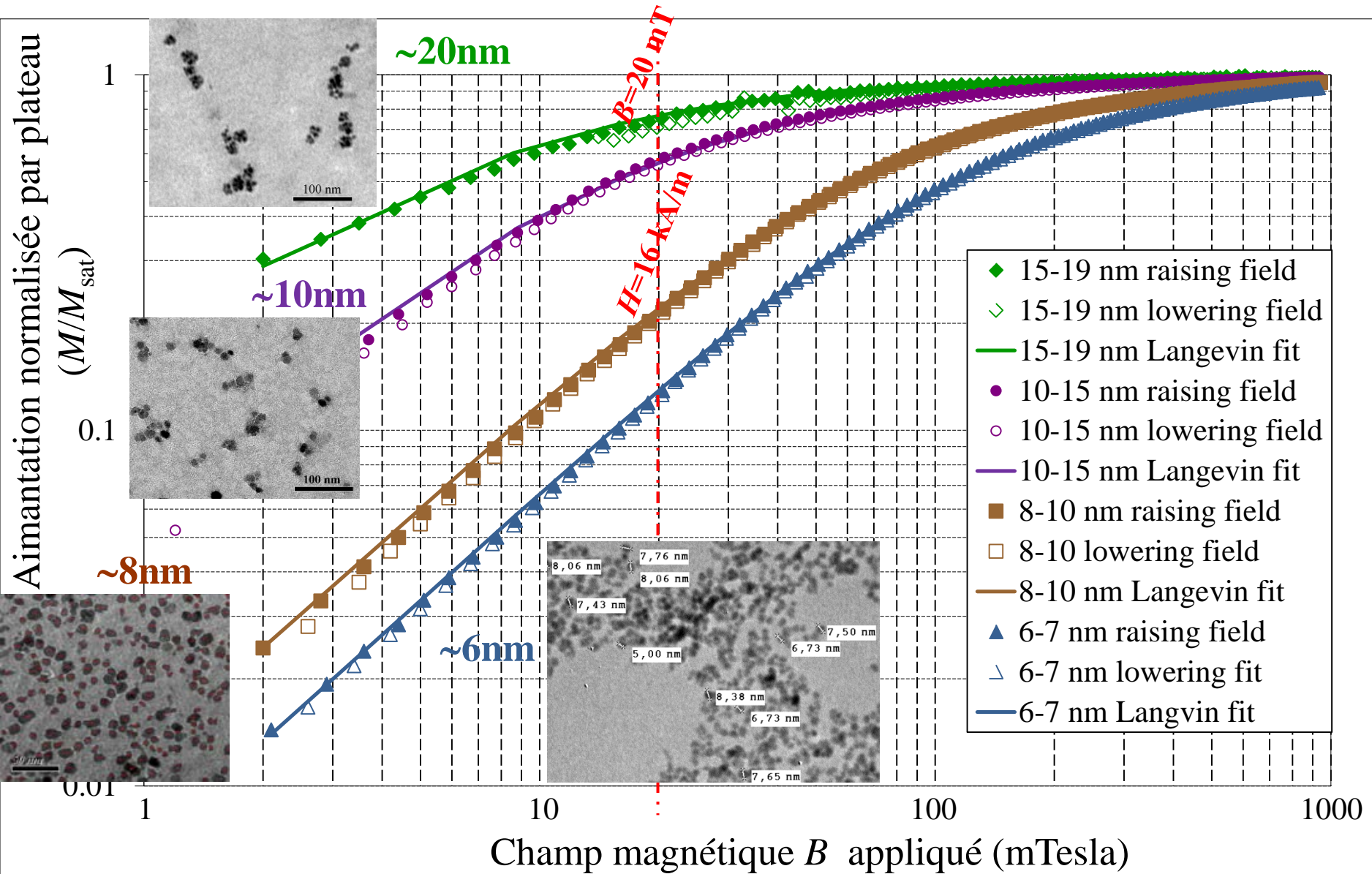

Larger nanoparticles for larger physical effects?

Obtained by multiple phase separation (C1C2C3C4)

$$\langle d \rangle_{\text{TEM}} = 13.9 \text{ nm}$$

$$\langle d \rangle_{\text{VSM}} = 11.8 \text{ nm}$$

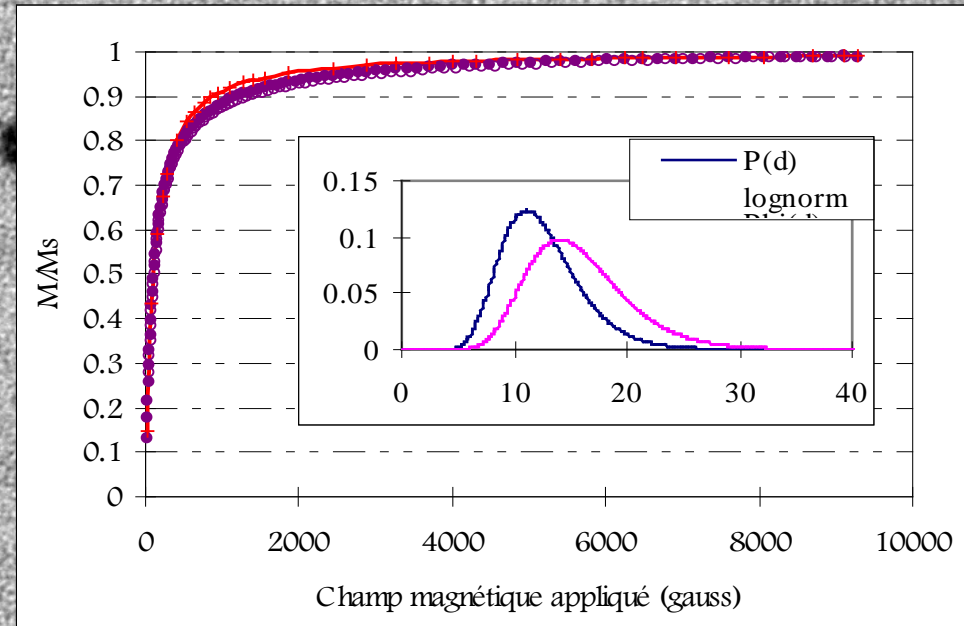
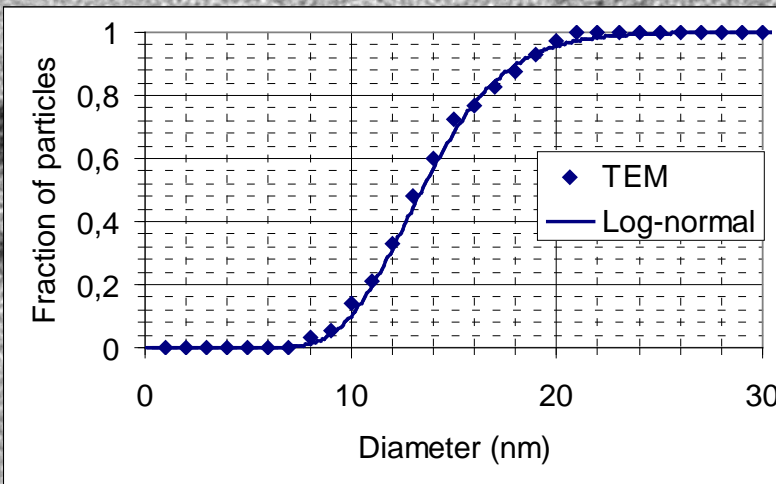
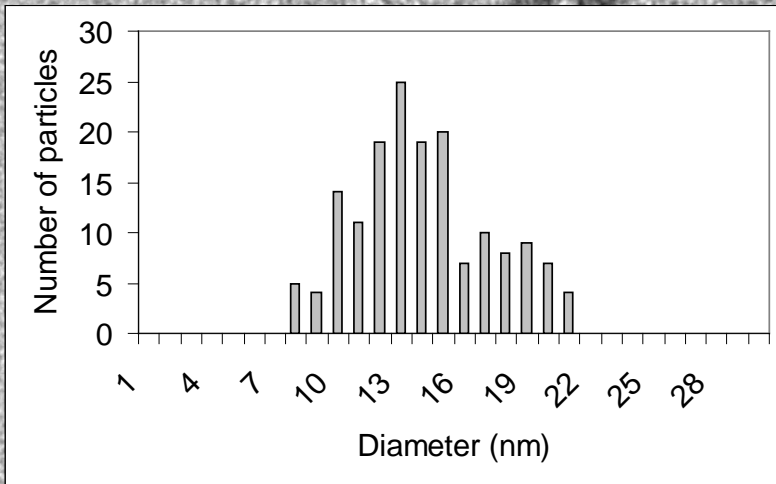

$$d_w = \langle d^4 \rangle / \langle d^3 \rangle_{\text{VSM or TEM}} \approx 16 \text{ nm}$$

$$\langle d^n \rangle = d_0^n \exp(n\sigma^2/2) \rightarrow d_w = \langle d^4 \rangle / \langle d^3 \rangle = d_0 \exp(3.5\sigma^2)$$

100 nm



Size-sorted fraction: C1C2S3S4

$\langle d \rangle_{\text{TEM}} = 13.3 \text{ nm}$

$d_w = \langle d^4 \rangle / \langle d^3 \rangle_{\text{VSM}} = 14.8 \text{ nm}$

Distributions des diamètres de l'échantillon RP1-C1C2S3S4@BNE-A d'après TEM et fits VSM

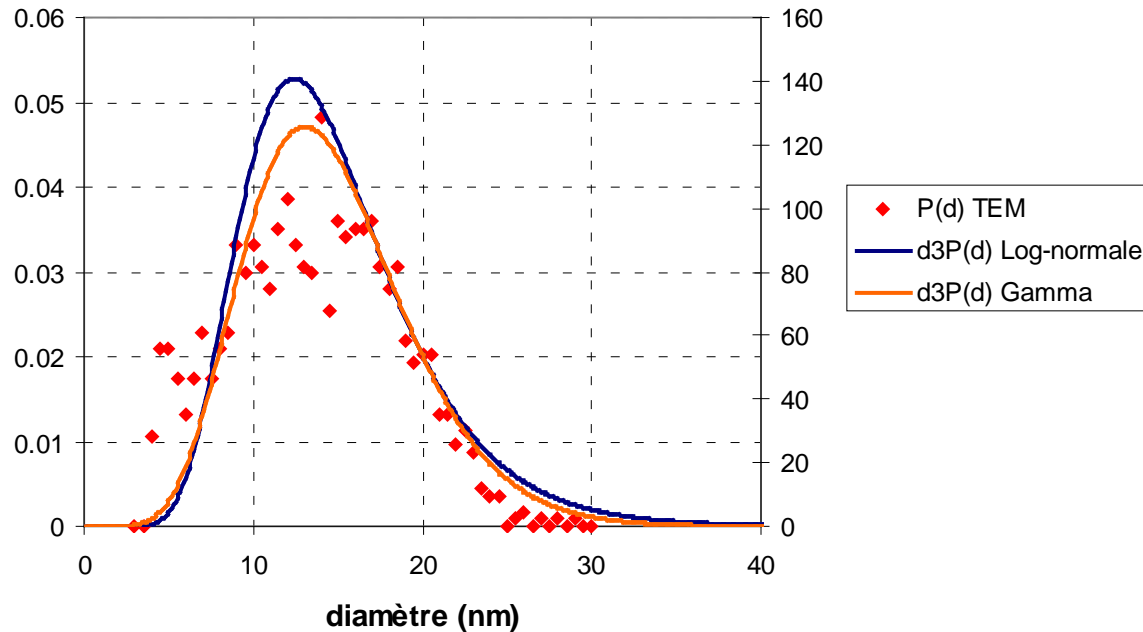

Vibrating sample magnetometry

$$M = \frac{1}{V_s} \int M_s \frac{\pi}{6} D^3 L\left(\frac{\mu_0 M_s \pi D^3 H}{6kT}\right) f_{LN}(D) dD$$

Smaller NPs
(S1S fraction d=6nm)

Larger NPs
(C1C fraction d=9nm)

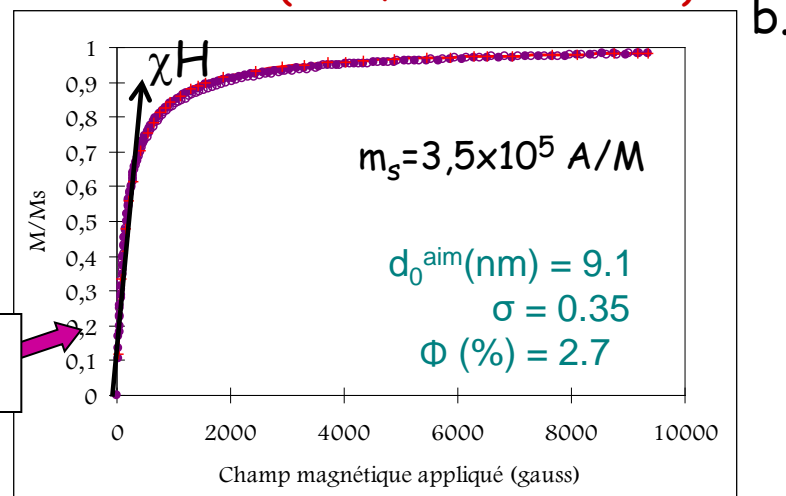
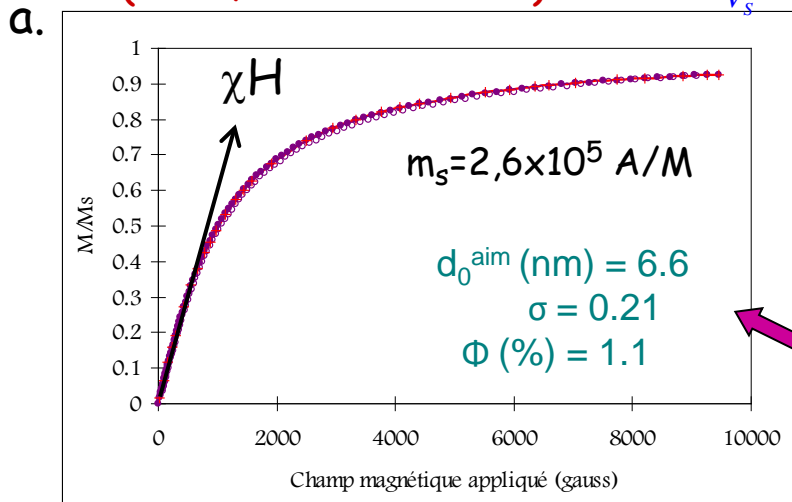

$$M_{\text{sat}} = m_s \Phi$$

1st order
Langevin's curve

Static Magneto-birefringence

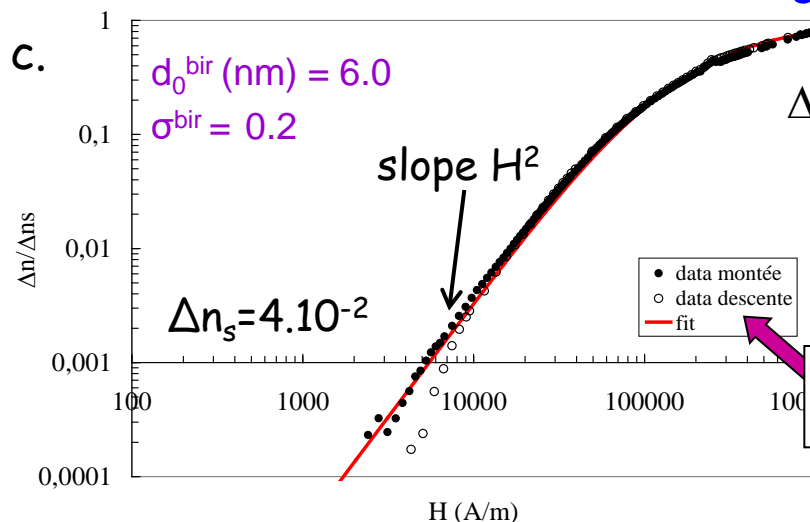

$$\Delta n_{\text{sat}} = \Delta n_s \Phi$$

2nd order
Langevin's curve

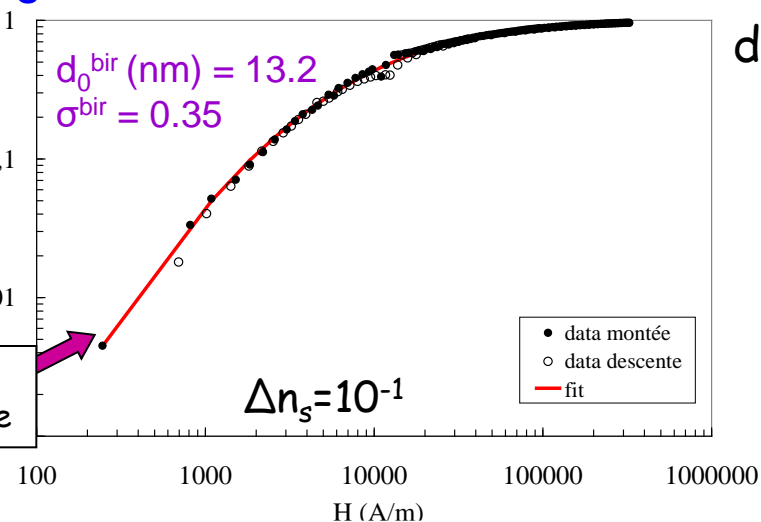

→ more monodisperse and superparamagnetic

→ larger, ferrimagnetic and more anisotropic

Particle form factors by small angle neutron scattering

SANS Intensity normalized by volume fraction Φ (cm⁻¹)



PACE spectrometer with Annie Brûlet

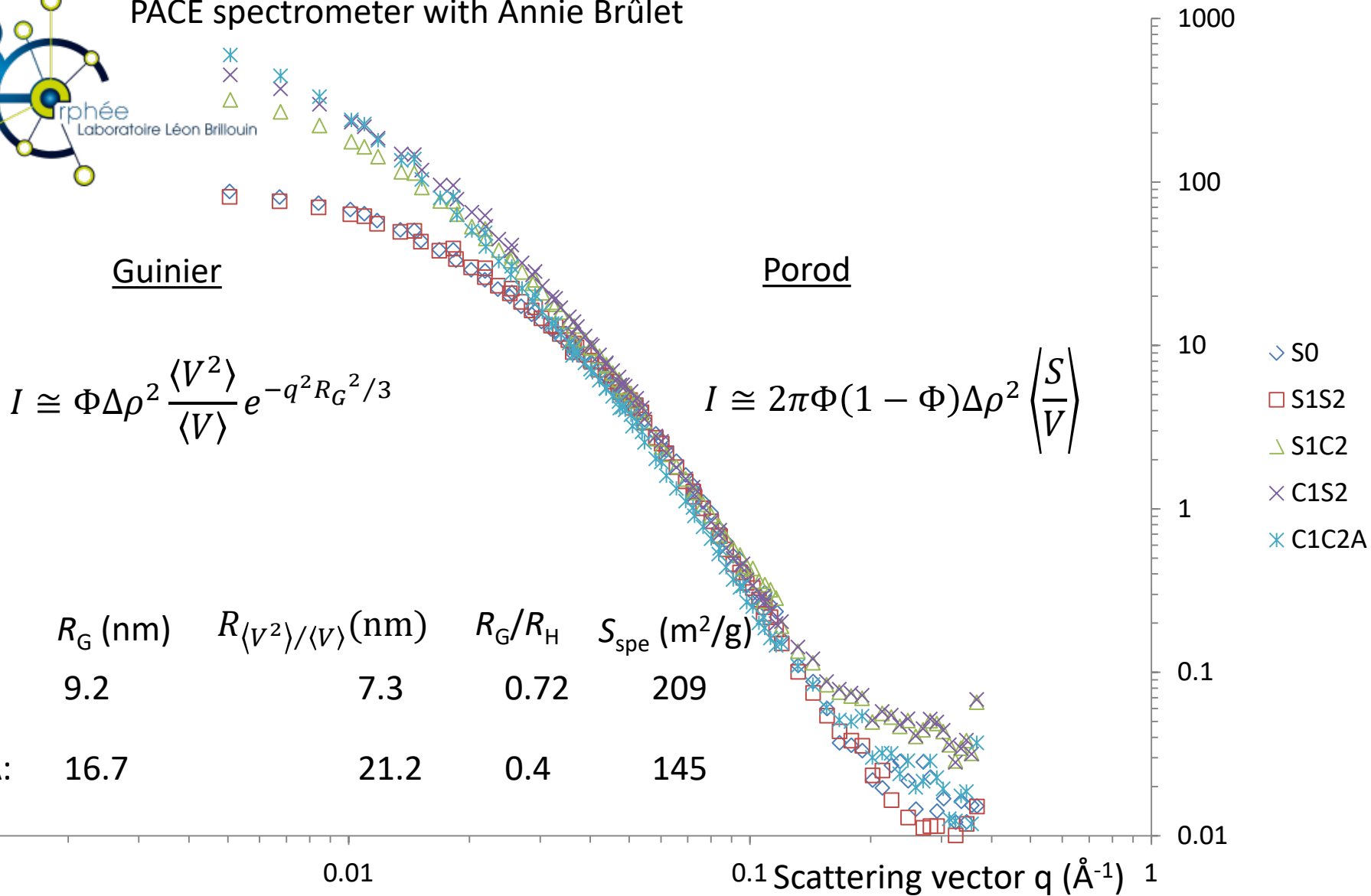

Synthesis & properties of multi-core "nanoflowers"

L. Lartigue, P. Hugounenq, D. Alloyeau, S. P. Clarke, M. Lévy, J-C. Bacri, R. Bazzi, D. F. Brougham, C. Wilhelm, F. Gazeau, ACS Nano 6, 10935–10949 (2012)

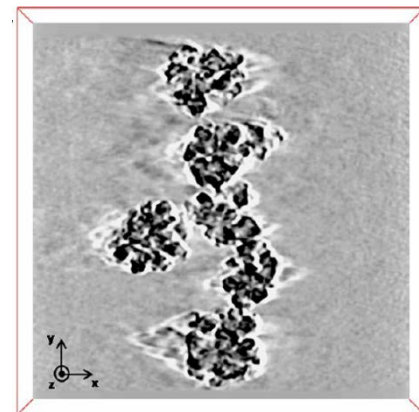
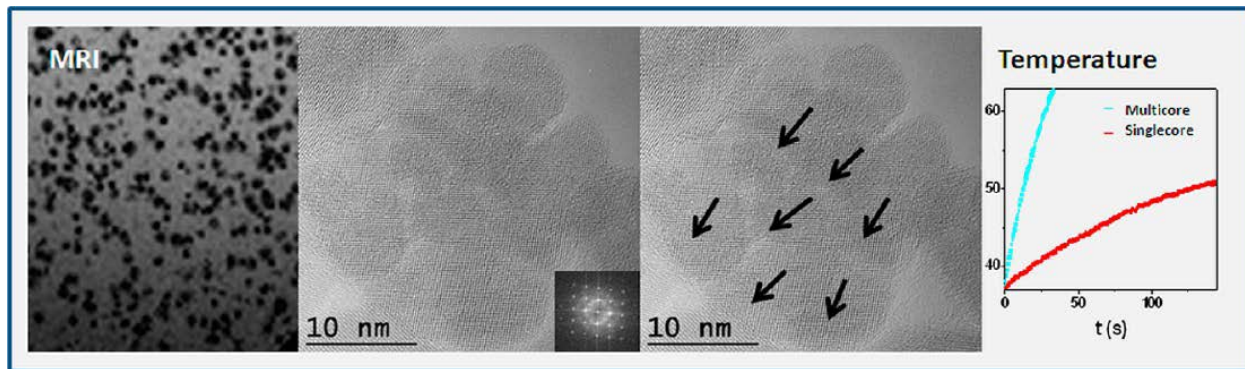

→ superior heating properties
(here values at $H_{max} = 29$ kA/m)

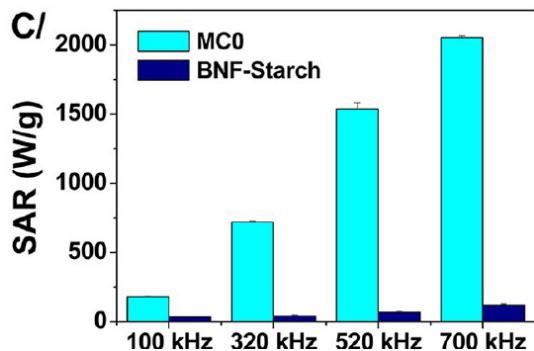

→ also high transverse relaxivity:
 $r_2 = 365 \text{ s}^{-1} \text{ mM}_{\text{Fe}}^{-1}$ at 9.25 MHz
(0.22 T / 37°C)

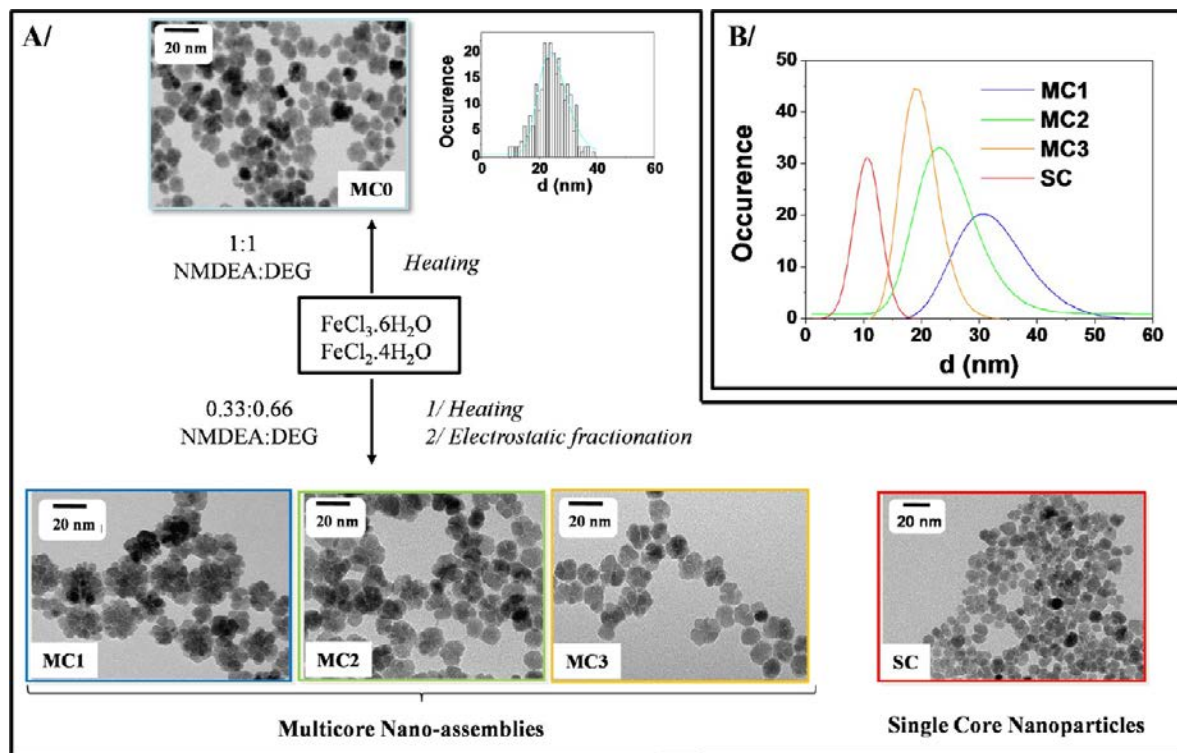

Nanoflower synthesis: the New Orleans method

D. Caruntu, G. Caruntu, Y. Chen, C. J. O'Connor, G. Goloverda,
V. L. Kolesnichenko, *Chem. Mater.* **2004**, *16*, 5527-5534

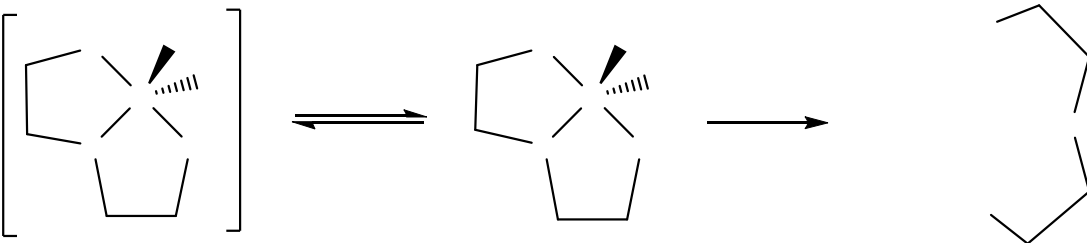

Polyol mixture: N-methyl diethanolamine / DEG (1:1)

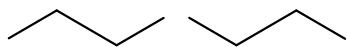

- 2 mmol FeCl₂
- 4 mmol FeCl₃
- 16 mmol NaOH
- 40 g DEG
- 40 g NMEDA
- 220°C 5h

Reflux

Stirring shaft

Internal T-probe

Aspiration flask for
washing steps

Ferrite slab for magnetic
sedimentation

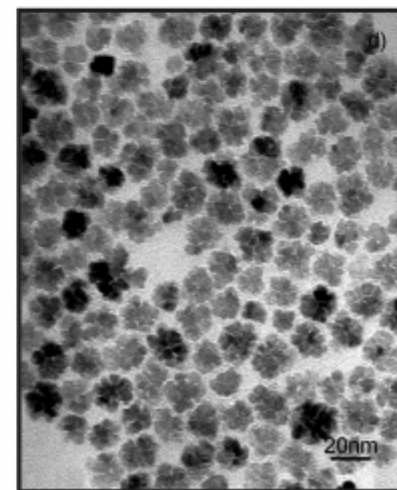
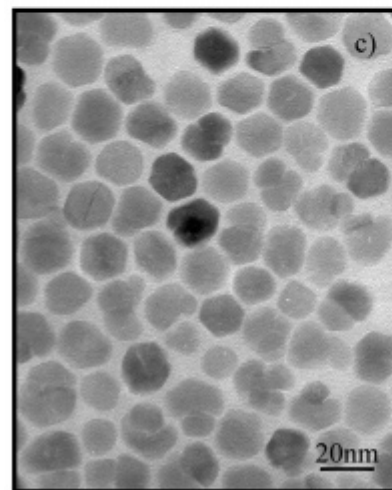
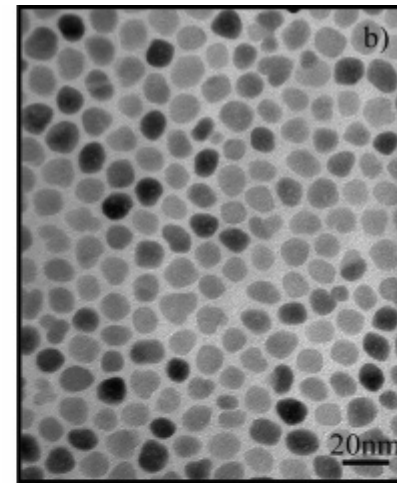
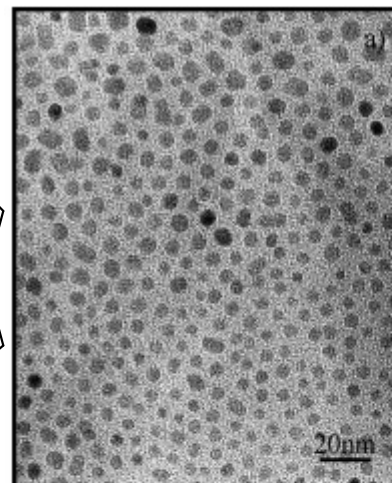
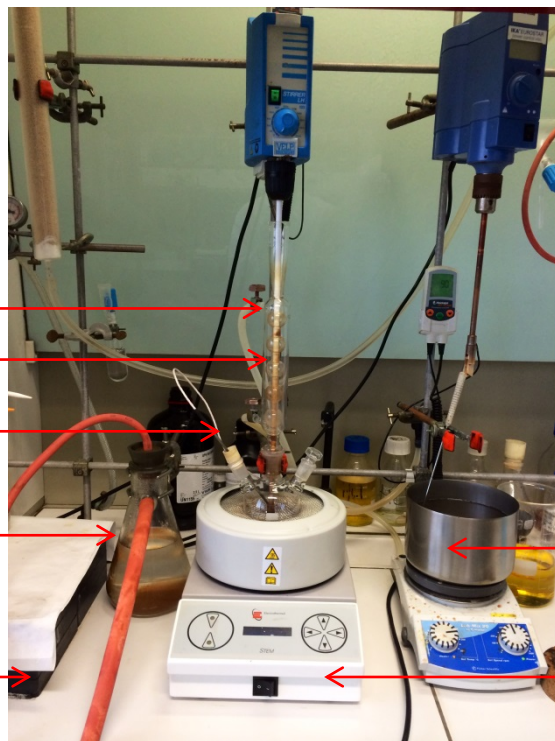

2nd heat/stirrer for
precursor dissolution

Dry heating mantle
(up to 250°C)

- Precursor
- Polyol composition
- Temp/Duration
- Water content

Forced hydrolysis mechanistic pathway (Caruntu)

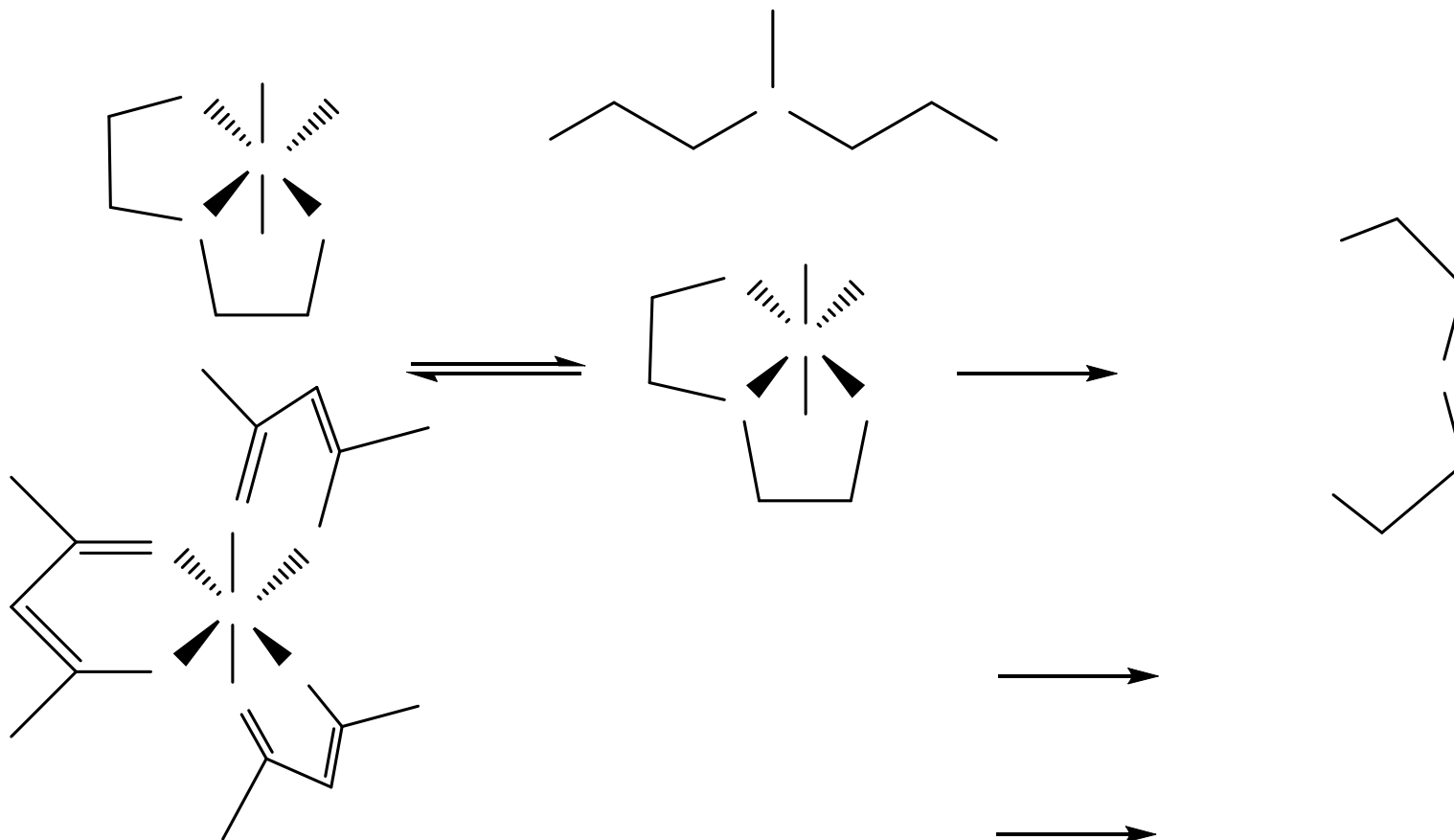

- 1) D. Caruntu, G. Caruntu, Y. Chen, C. J. O'Connor, G. Goloverda, V. L. Kolesnichenko, *Chem. Mater.* **2004**, *16*, 5527-5534;
- 2) S. Sun and H. Zeng et al, *J. A. C. S.*, **2002**, *124*, 8204-8205 and **2004**, *126*, 273-279
- 3) F.A. Tourinho, R. Franck, R. Massart, *J. Materials Science* **1990**, *25*, 3249-3254

Large library of sample batches

Batch name	Nomenclature
15ff	DN1000 _{HU} -5h
17ff	D5000 _{HI} -20m
25ff	DN500 _{HU} -4h
30ff	DN1000 _{HU} -5h
31ff	DN500 _{HU} -1h
32ff	DN500 _{HU} -5h
34ff	DN100 _{HU} -5h*
35ff	DN100 _{HU} -5h
36ff	DN100 _{HU} -5h

Batch name	Nomenclature
28AA	DN100 _{HU} -220-5h-Cl
29AA	DN200 _{HU} -220-5h-Cl
02MA	DN300 _{HU} -220-5h-Cl
09MA	DN400 _{HU} -220-5h-Cl
10MA	DN500 _{HU} -220-5h-Cl
11MA	DN50 _{HU} -220-5h-Cl
27MA	DN0-220-5h-Acac
12MA	DN100-220-5h-Acac
17MA	DN200-220-5h-Acac
18MA	DN300-220-5h-Acac
19MA	DN400-220-5h-Acac
20MA	DN500-220-5h-Acac
15JA	DD100-250-5h-Cl
10JA	TD100-250-5h-Cl

Vary μ L water in 120 g polyol mixture:

EG: Ethylene Glycol D=pure DEG
 DEG: Diethylene Glycol DN=DEG/NMDEA (1:1)
 TEG: Triethylene Glycol DD=DEG/DEA (1:1)
 DEA: Diethanolamine TD=TEG/DEA (1:1)

NMDEA: N-methyldiethanolamine

TEA: Triethanolamine

DIA: N-ethyl Diisopropylamine

HU=heating up

HI=hot injection

* no stirring

Cl=2 mmol FeCl₂, 4 mmol FeCl₃, 16 mmol NaOH

Acac=6 mmol Fe(acac)₃, 16 mmol NaOH

Study of polyol route: fate of solvent molecules

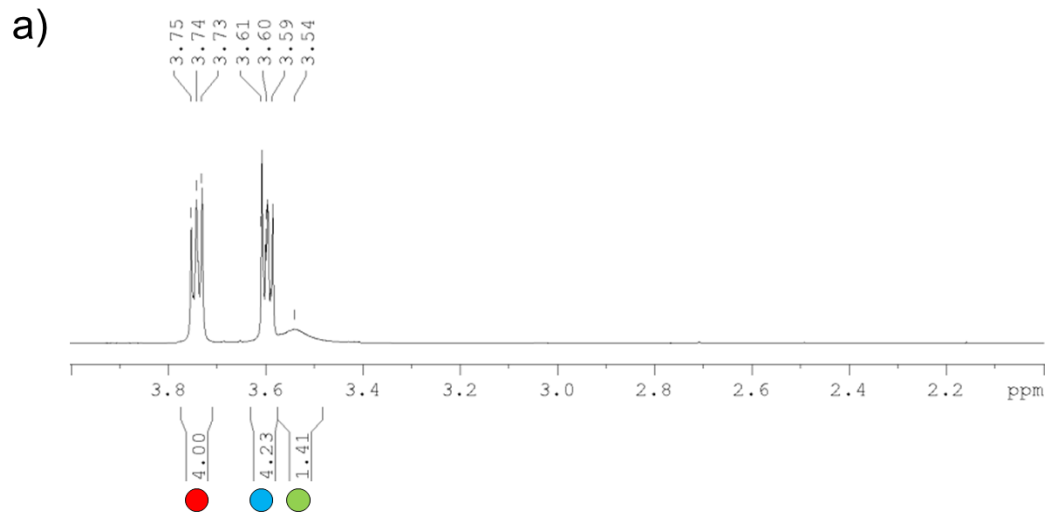

Diethylene glycol (DEG)

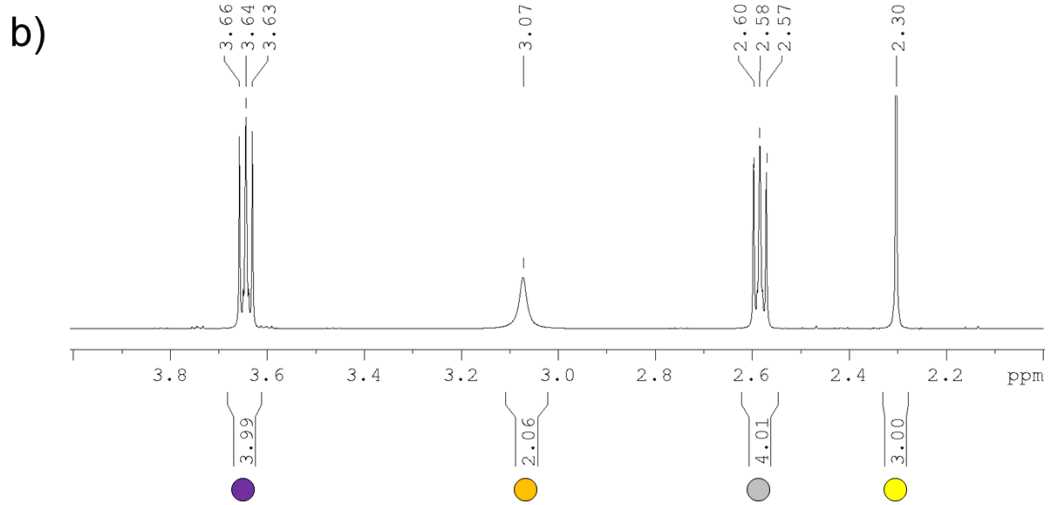

N-methyldiethanolamine (NMDEA)

Study of polyol route: fate of solvent molecules

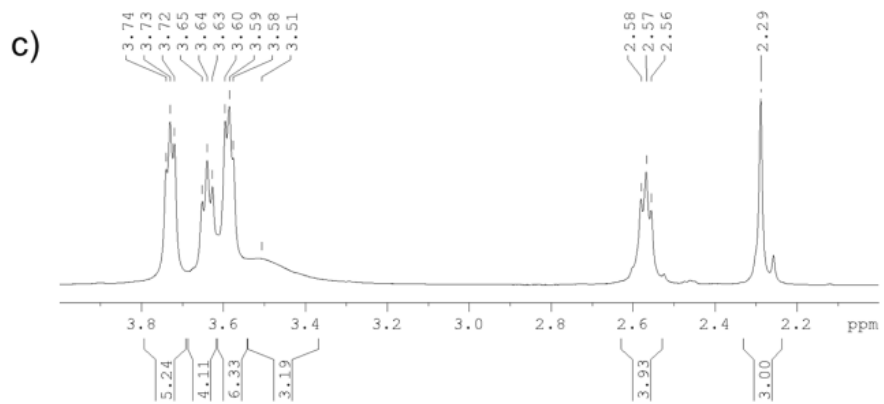

DEG, NMDEA, NaOH, FeCl₂, FeCl₃

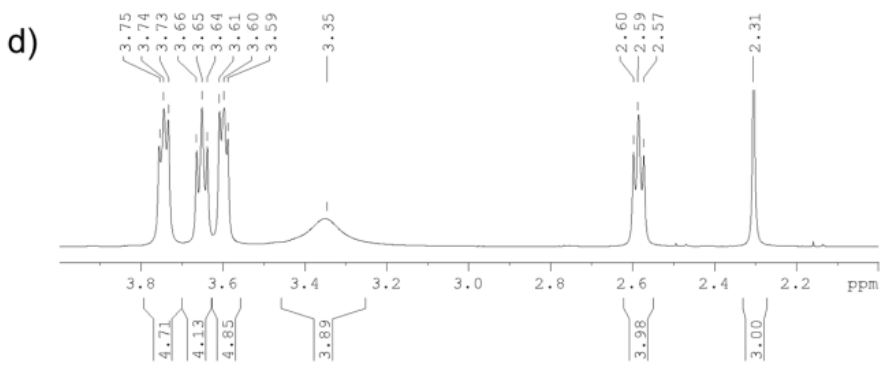

DEG, NMDEA, NaOH, FeCl₂, FeCl₃, H₂O
Before reaction

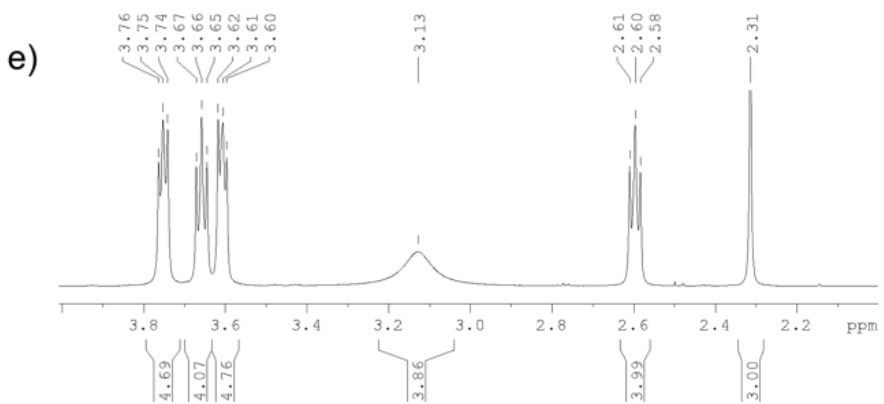

DEG, NMDEA, NaOH, FeCl₂, FeCl₃, H₂O
After reaction

Study of polyol route: fate of solvent molecules

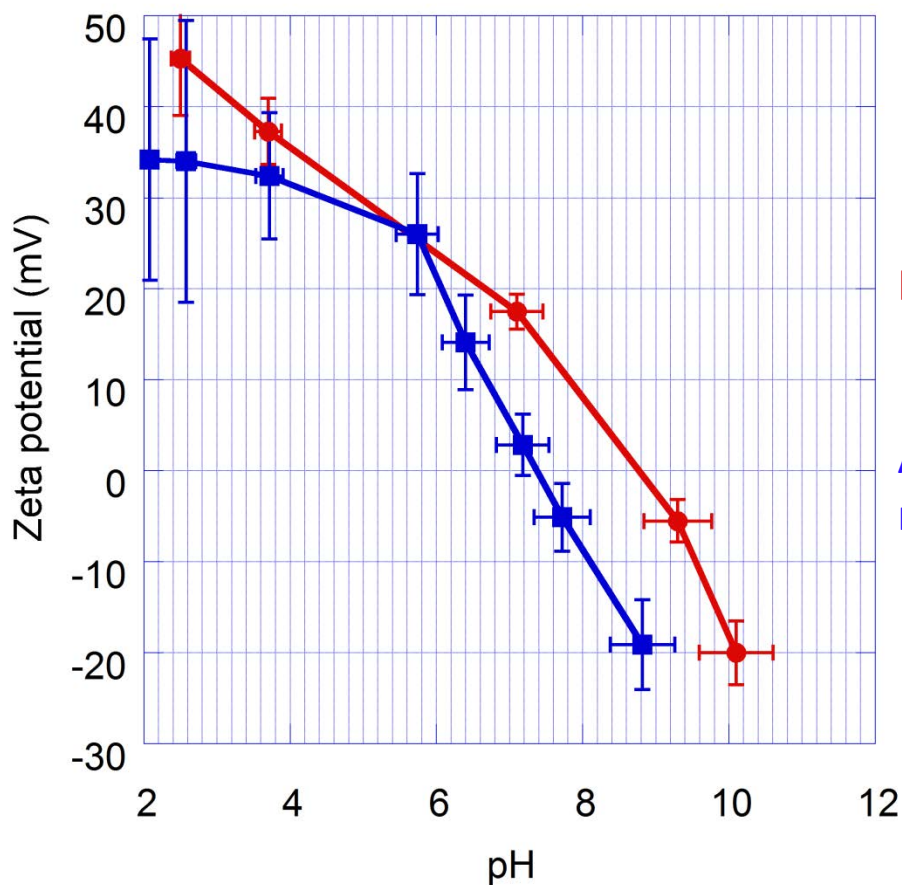

Right after synthesis
→ PZC = pKa of NMDEA

After washings (precipitation-
redispersion cycles at alkaline pH)

- Can be oxidized in boiling $\text{Fe}(\text{NO}_3)_3$: $\text{Fe}_3\text{O}_4 \rightarrow \gamma\text{-Fe}_2\text{O}_3$
- Washed and stabilized in water at $\text{pH} \sim 7$ with citrate ligand or PEG-phosphonate

Hydrodynamic size by DLS

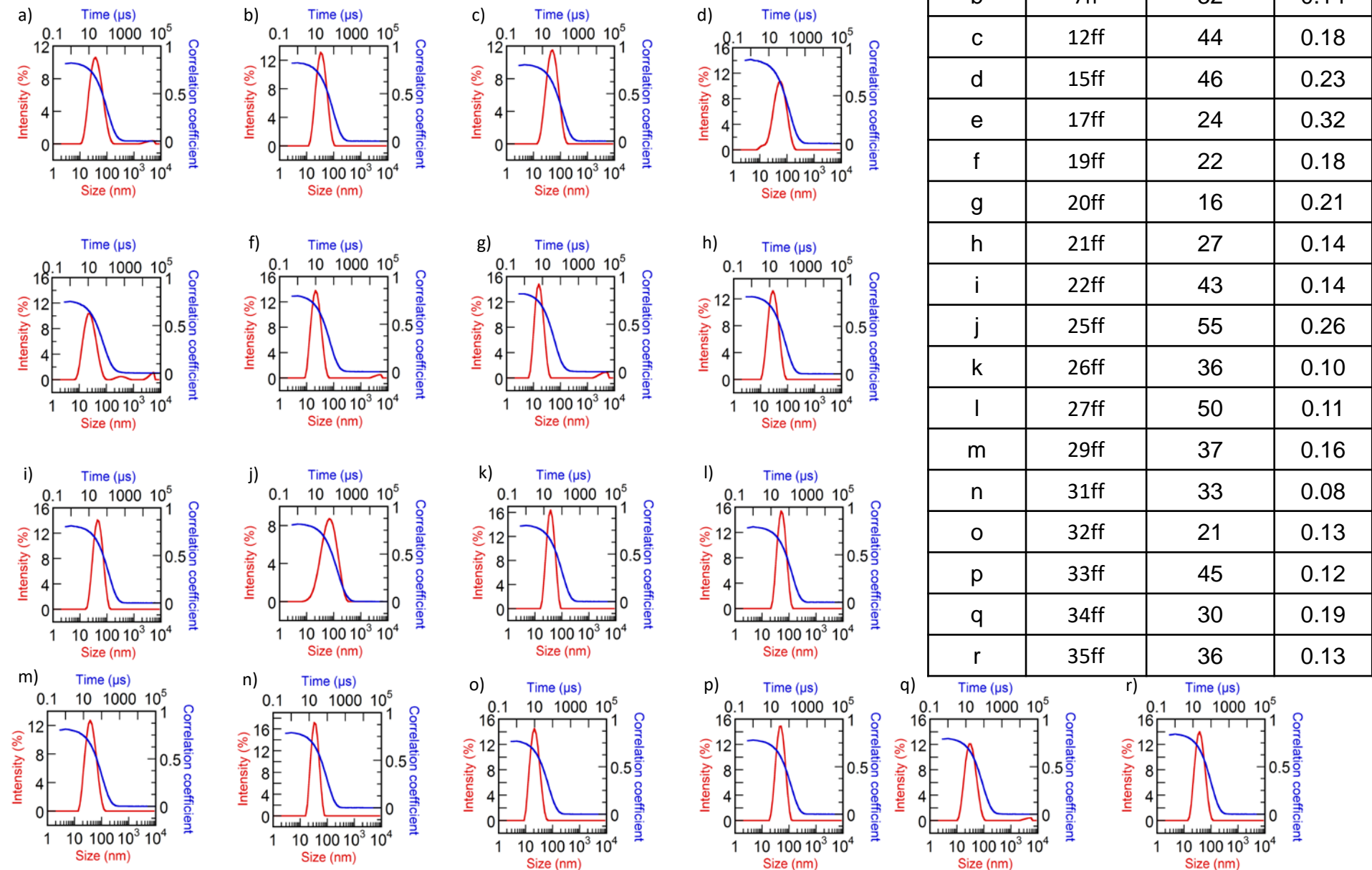

Variety of Fe_3O_4 NP batches synthesized in DEG:NMDEA

$$\langle d \rangle = d_0 e^{\sigma^2/2} \quad \text{var}(d) = d_0^2 (e^{\sigma^2/2} - 1)$$

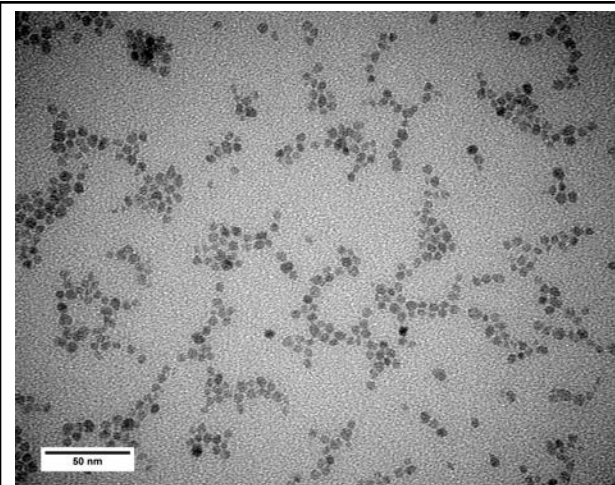

4FF: $d = 6.2 \pm 1.0$ nm

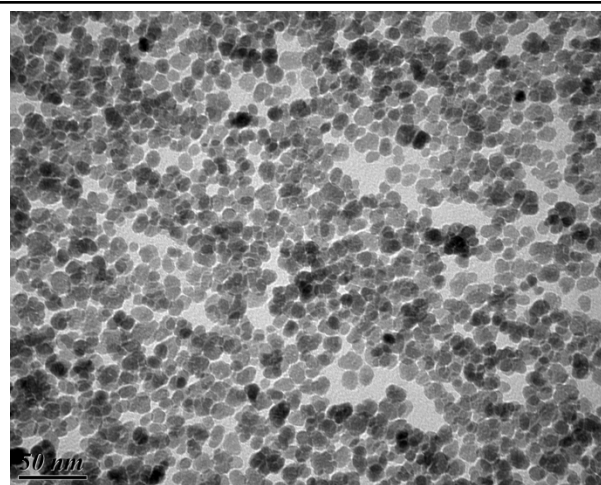

23FF: $d = 10.5 \pm 1.9$ nm

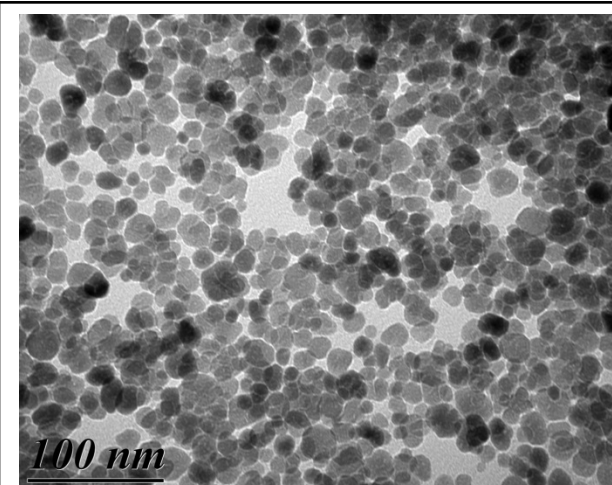

25FF: $d = 14.2 \pm 3.2$ nm

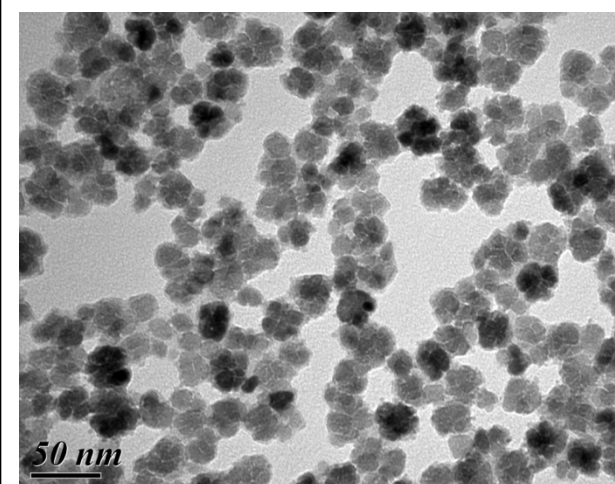

29FF: $d_{\text{out}} = 26.6 \pm 4.2$ nm

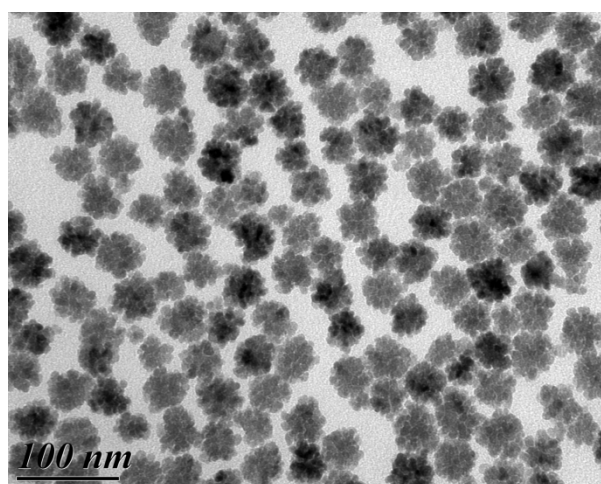

15FF: $d_{\text{out}} = 36.3 \pm 4.8$ nm

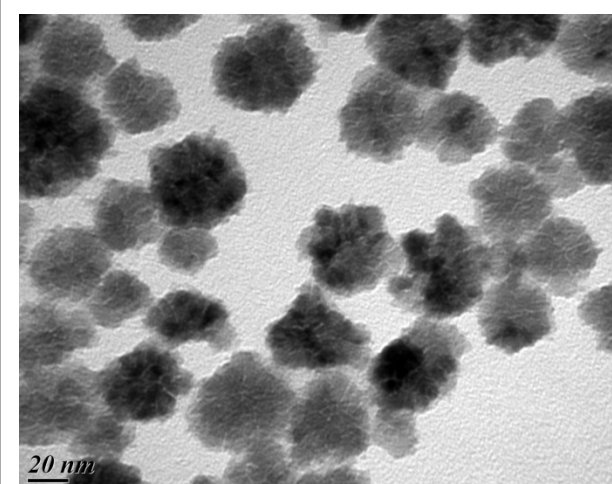

30FF: $d_{\text{out}} = 41.1 \pm 8.6$ nm

G. Hemery, A. C. Keyes Jr., E. Garaio, I. Rodrigo, J. A. Garcia, F. Pazaola, E. Garanger,

O. Sandre, arXiv preprint: [1701.05858](https://arxiv.org/abs/1701.05858)

Example of ultra-small nanosphere sample: 17FF

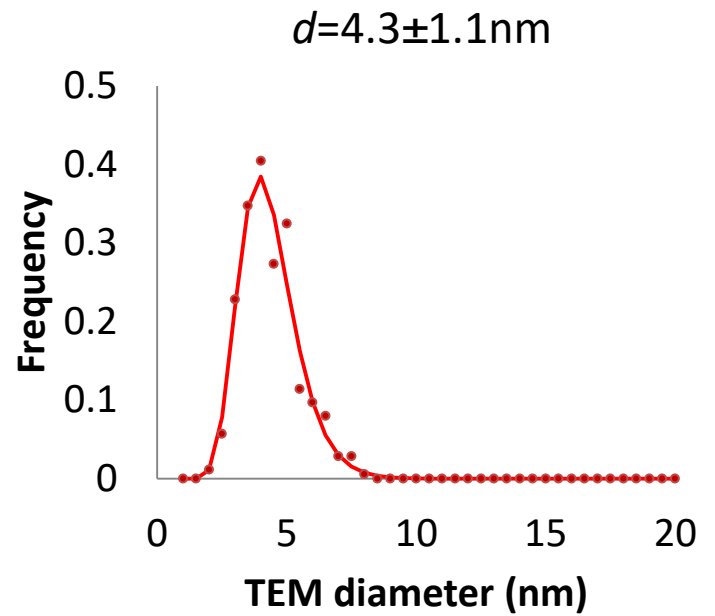
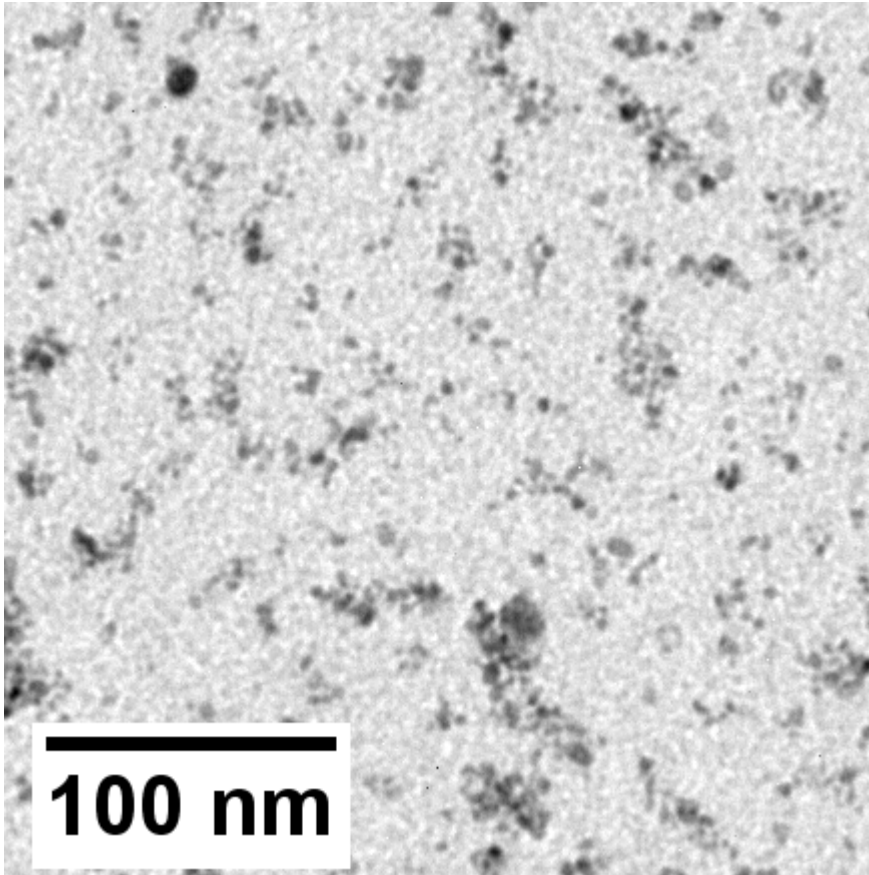

Example of medium size nanosphere sample: 25FF

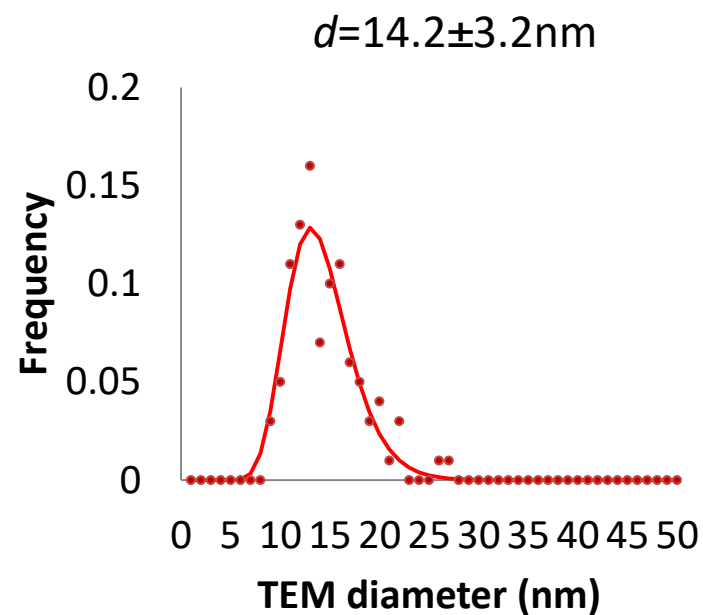
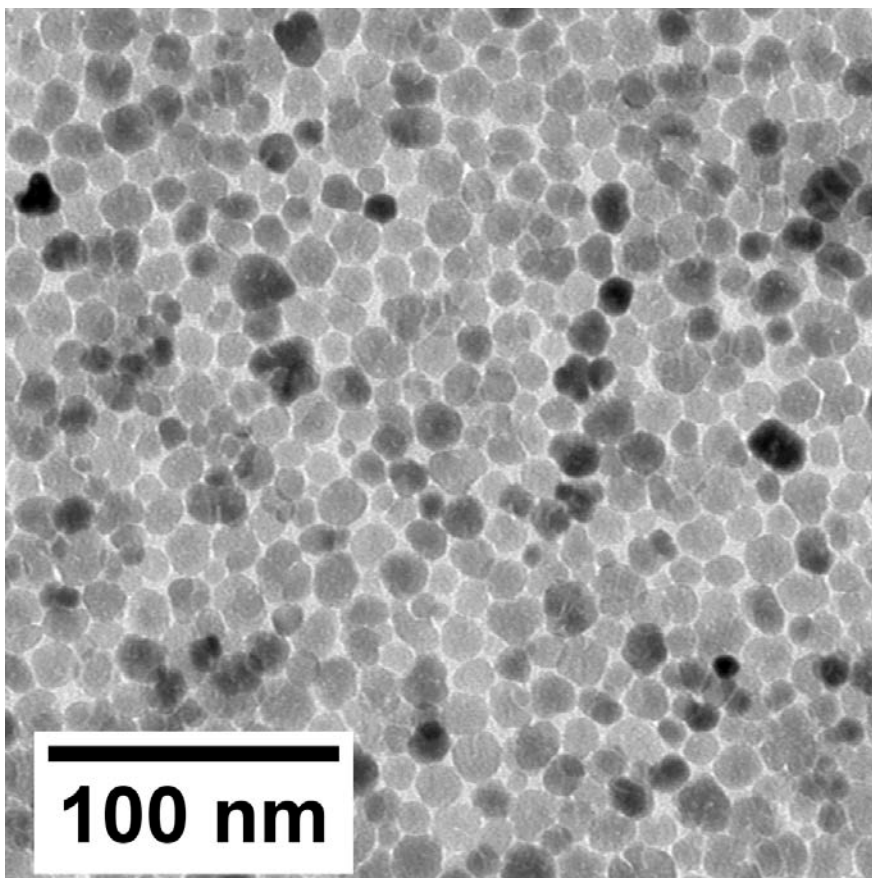

Example of very large size nanosphere sample: 34FF

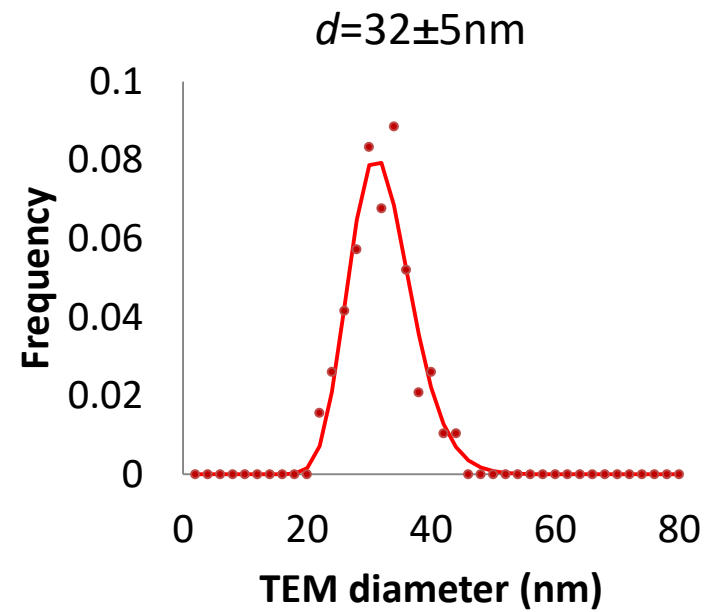
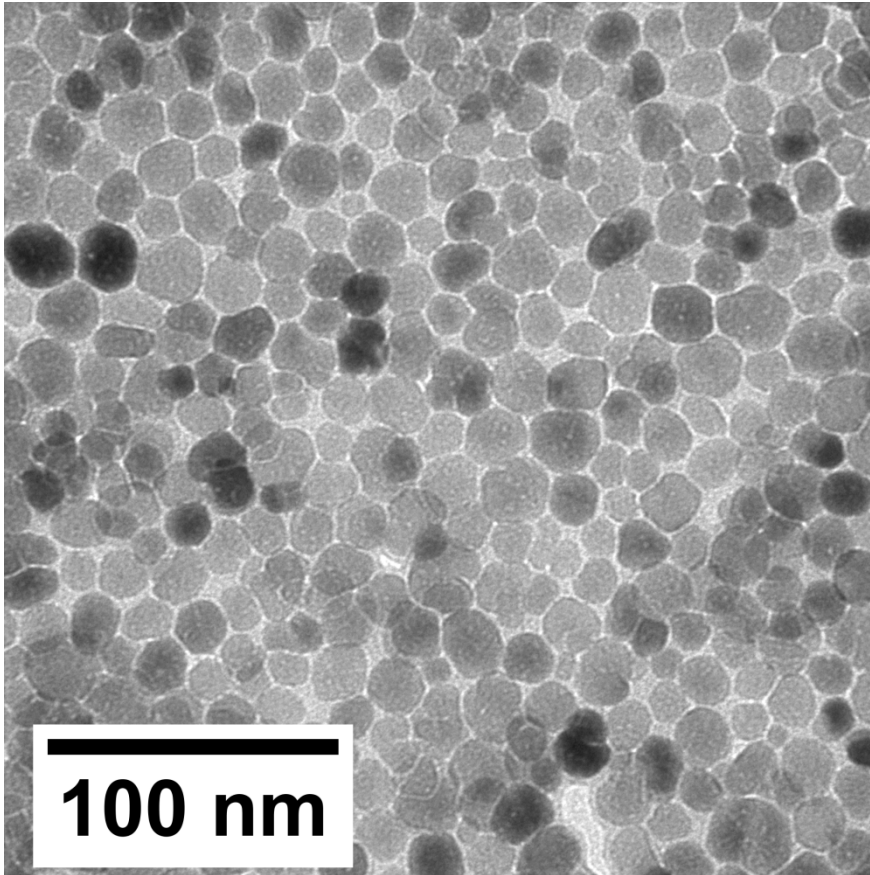

Example of nanoflower sample: 15FF

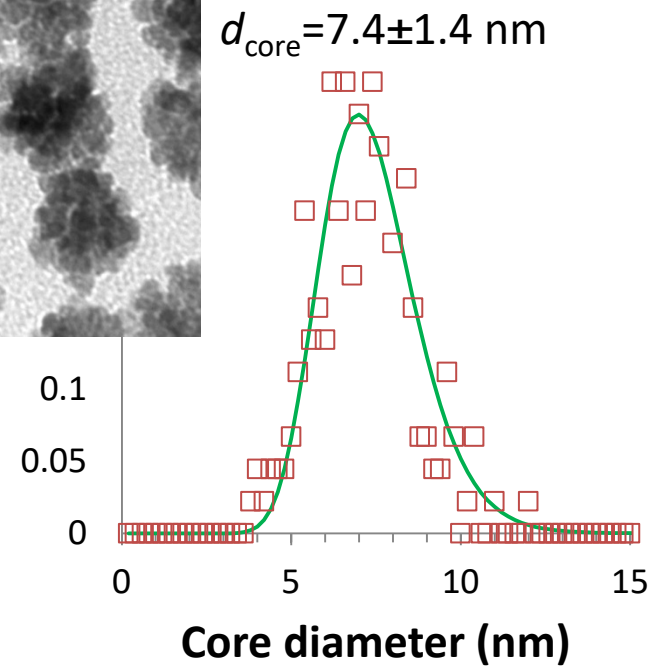
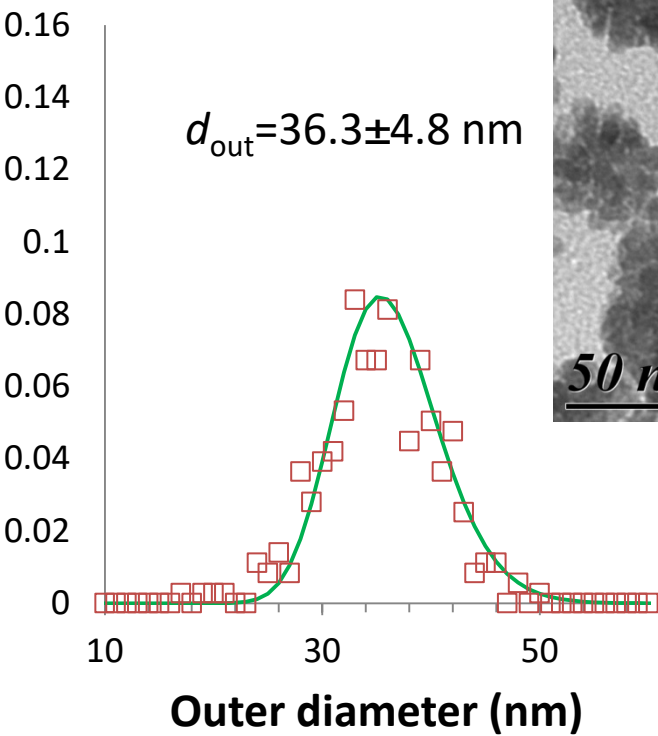
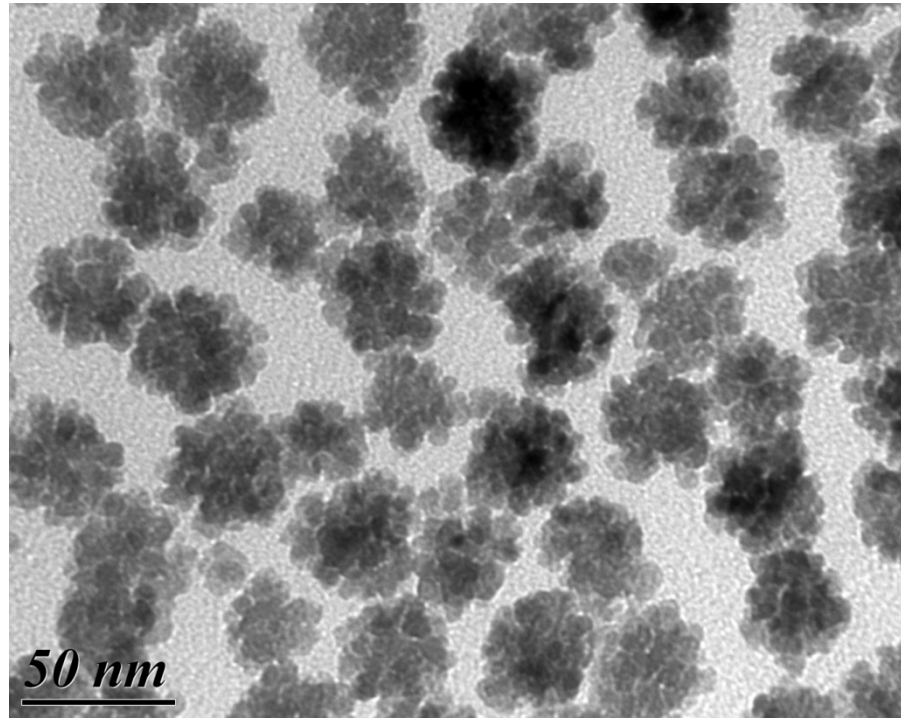

Particle form factors by small angle neutron scattering

PACE spectrometer
with Annie Brûlet

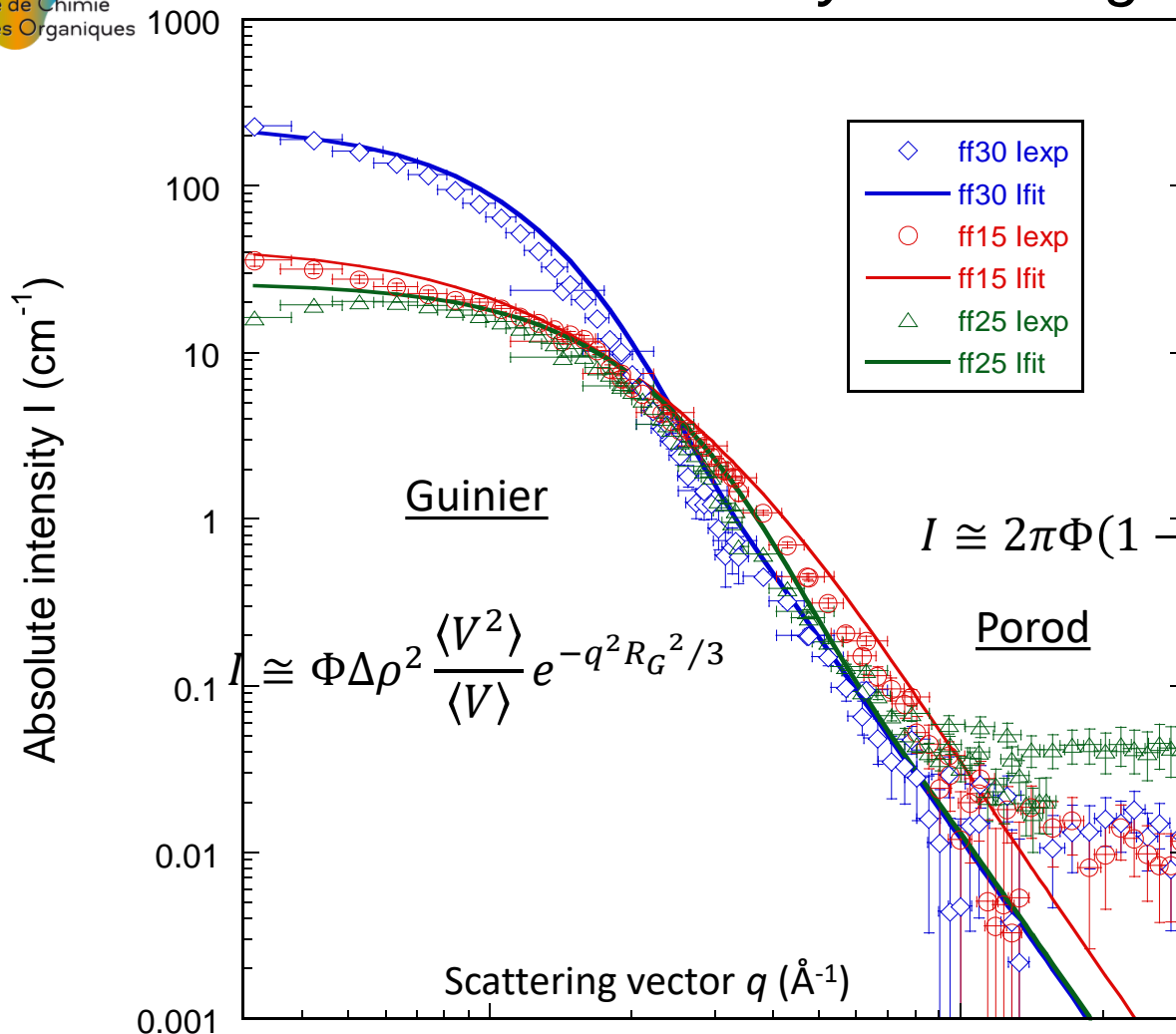

$$I \cong 2\pi\Phi(1 - \Phi)\Delta\rho^2 \left\langle \frac{S}{V} \right\rangle$$

$$I \cong \Phi\Delta\rho^2 \frac{\langle V^2 \rangle}{\langle V \rangle} e^{-q^2 R_G^2 / 3}$$

$$\left\langle \frac{S}{V} \right\rangle^{\text{the}} = 3 / \left(R_{\langle V^2 \rangle / \langle V \rangle} \right)$$

	0.01	R_G (nm)	$R_{\langle V^2 \rangle / \langle V \rangle}$ (nm)	R_{TEM} (nm)	S_{spe} (m ² /g)	$S_{\text{spe}}^{\text{the}}$
30ff:		18.9	18.1±3.9	23.5 ± 4.2	31.7	33.1
25ff:		10.5	10.4±2.3	7.1 ± 1.6	52.6	57.7
15ff:		19	10.6±3.9	17.5 ± 2.4	89.9	56.6

Experimental measurement of all properties (m_S , Δn_S , SHP, $P(q)$, r_1 , r_2 ...) require the total iron concentration.

Available methods are:

- Atomic Absorption Spectroscopy (or ICP): sensitive ($10^{-5}M$) but $\pm 5\%$
- Redox titration (Charlot) by $K_2Cr_2O_7/SnCl_2$: precise ($\pm 1\%$) but not sensitive ($10^{-1}M$)
- Whole UV-Vis curve: precise ($\pm 1\%$) and sensitive ($10^{-4}M$)
- “Ferrozine assay”: highly sensitive ($10^{-7}M$) from OD_{562nm} according to *Small* 5 (2009) 256

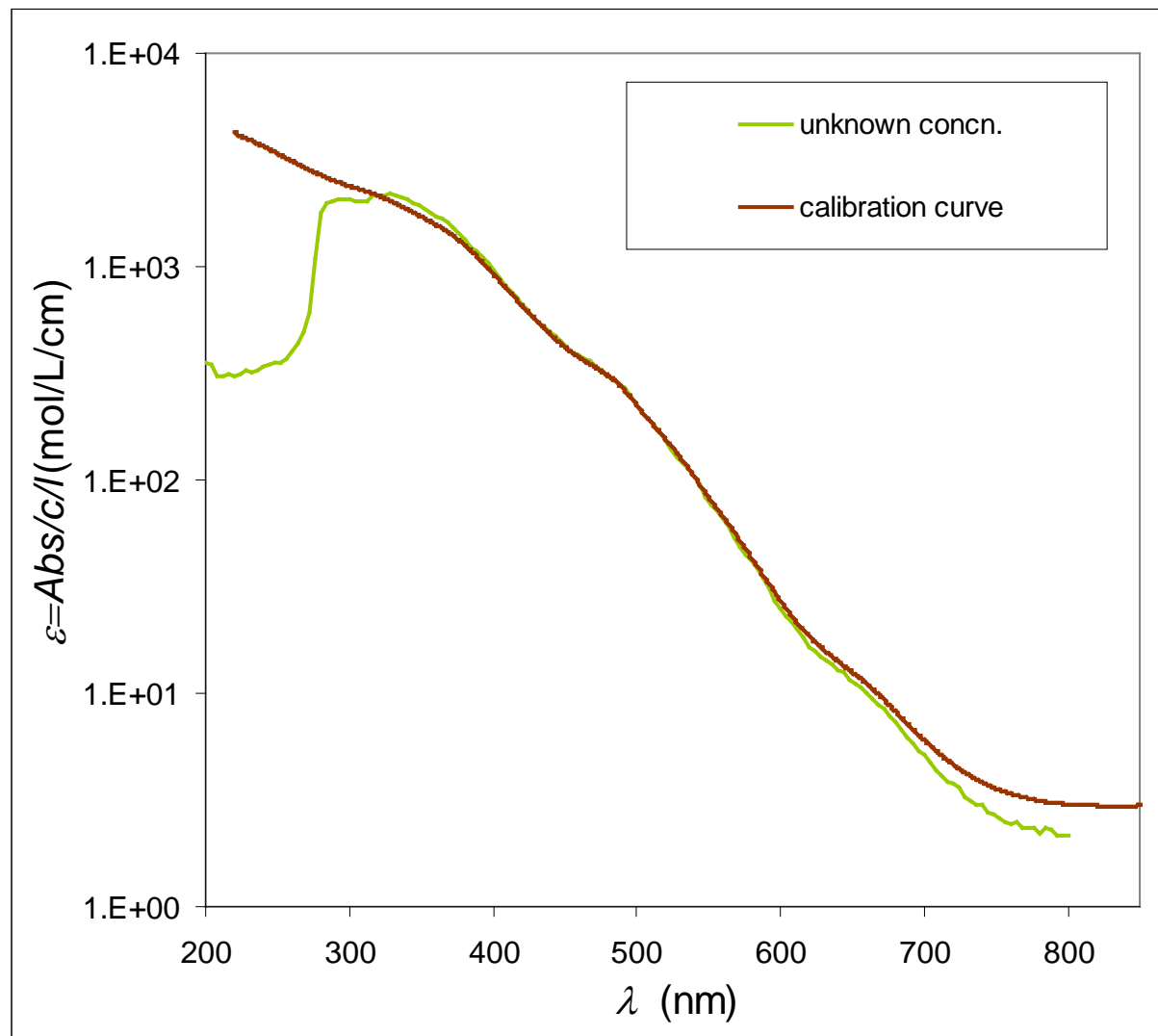

UV-Vis extinction is independent on MNP size distribution

Constant →

UV-Vis molar extinction coefficient →

$$\epsilon = \frac{c(h\nu - E_g^{bulk})^{1/2}}{h\nu}$$

3,6 eV for Fe₂O₃
Shannon, *J. Phys. Chem. Ref. Data* 2002

A. Abou-Hassan
UPMC thesis 2009
2010 Best thesis
prize in physical
chemistry
(SFP/SCF)
→ no size-dependent
gap in the case of γ -
Fe₂O₃
(the exciton
diffusion length is
presumably much
smaller than the size
of the USPIOs, thus no
confinement)

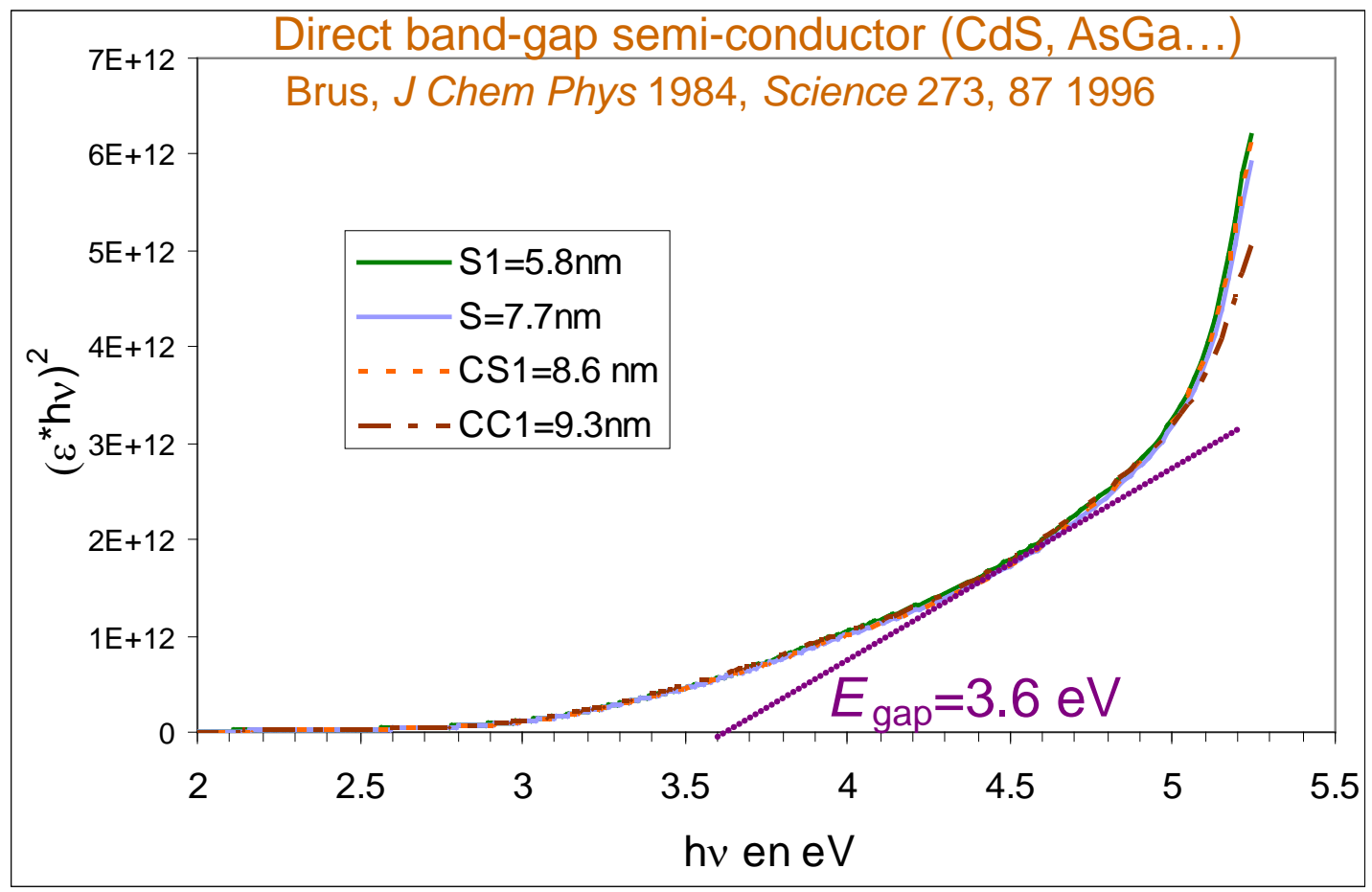

- Since 30 years, the aqueous route (alkaline coprecipitation) leads to a quantitative production ($\sim 100\text{g}$ dry $\gamma\text{-Fe}_2\text{O}_3$) of magnetic nanoparticles that can be further functionalized (organic solvent, polymer matrix, biological coatings...). Today the up-scalable method is polyol route.
- Samples have inherent size / shape polydispersity, which can be a drawback for long-range ordering (e.g. colloidal or liquid crystals) but, according to Curie's principle, this is a great advantage to get large physical properties!
- The outlooks for biological applications (MRI contrast agents and magnetic hyperthermia) might be to play on the anisotropy constant K_a (shape anisotropy or other "irregularity") rather than on the size only, because of the difficulty to stabilize large MNPs (e.g. $\text{Ø} > 20\text{nm}$) in biological media (ionic strength and flocculent proteins).