



HAL
open science

Energy Harvesting from Ambient Vibrations

Frédéric Giraud

► **To cite this version:**

| Frédéric Giraud. Energy Harvesting from Ambient Vibrations. Master. France. 2012. hal-02495300

HAL Id: hal-02495300

<https://cel.hal.science/hal-02495300v1>

Submitted on 1 Mar 2020

HAL is a multi-disciplinary open access archive for the deposit and dissemination of scientific research documents, whether they are published or not. The documents may come from teaching and research institutions in France or abroad, or from public or private research centers.

L'archive ouverte pluridisciplinaire **HAL**, est destinée au dépôt et à la diffusion de documents scientifiques de niveau recherche, publiés ou non, émanant des établissements d'enseignement et de recherche français ou étrangers, des laboratoires publics ou privés.

Energy Harvesting from Ambient Vibrations

Frédéric Giraud

L2EP – University Lille1

November 27, 2012

Table of contents

- 1 Introduction
 - What is Energy Harvesting ?
 - Generator Technologies
 - Summary
- 2 Modelling of a piezoelectric energy harvester
 - Presentation of the system
 - EMR of the system
 - Power Extraction on a load resistor R_L from harmonic oscillation
- 3 An Example of inverter
 - Introduction
 - SSHI: Synchronized Switch Harvesting on Inductor

What is Energy Harvesting ?

We extract energy from an *ambient and free source*:

What is Energy Harvesting ?

We extract energy from an *ambient and free source*:

- *Wind*
- *Light*
- *Vibrations*
- *Thermal*
- ...

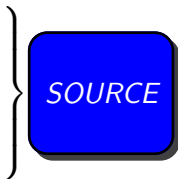

What is Energy Harvesting ?

We extract energy from an *ambient and free source*:

- Wind
- Light
- Vibrations
- Thermal
- ...

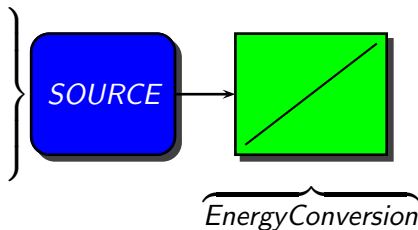

What is Energy Harvesting ?

We extract energy from an *ambient and free source*:

- Wind
- Light
- Vibrations
- Thermal
- ...

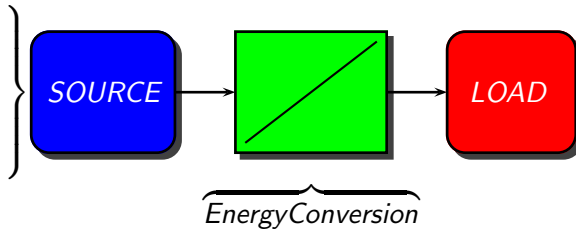

What is Energy Harvesting ?

We extract energy from an *ambient and free source*:

- Wind
- Light
- Vibrations
- Thermal
- ...

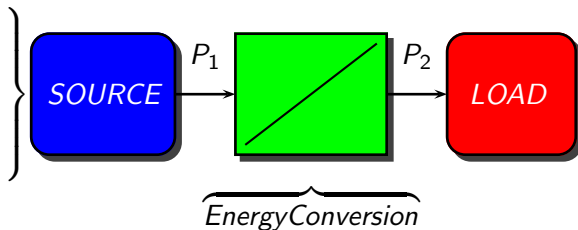

What is Energy Harvesting ?

We extract energy from an *ambient and free source*:

- Wind
- Light
- Vibrations
- Thermal
- ...

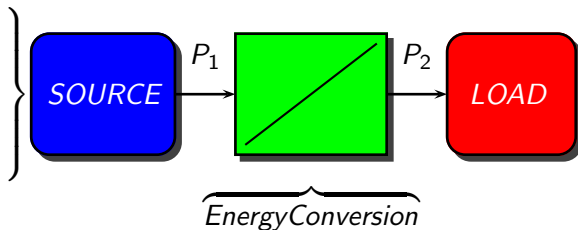

We talk about **Energy Harvesting** or also **energy scavenging** when the converted power is small, typically less than 1W.

What is Energy Harvesting ?

We extract energy from an *ambient and free source*:

- Wind
- Light
- Vibrations
- Thermal
- ...

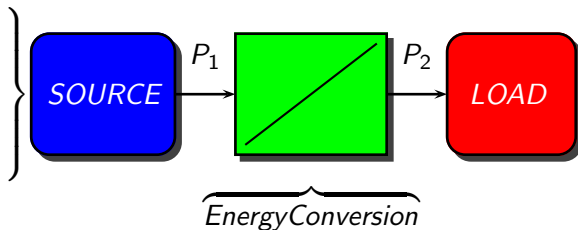

We talk about **Energy Harvesting** or also **energy scavenging** when the converted power is small, typically less than 1W.

$\eta = \frac{P_2}{P_1} = 1 - \frac{P_1 - P_2}{P_1} \rightarrow$ Losses in the energy converter should be as small as possible.

Objectives: Sensors Network



www.perpetuum.com

Objectives: Sensors Network



www.perpetuum.com

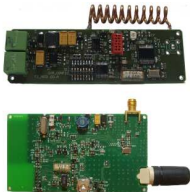

Gutiérrez, A Heterogeneous Wireless Identification Network for the Localization of Animals Based on Stochastic Movements

Objectives: Sensors Network

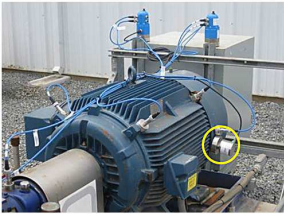

www.perpetuum.com



Gutiérrez, A Heterogeneous Wireless Identification Network for the Localization of Animals Based on Stochastic Movements

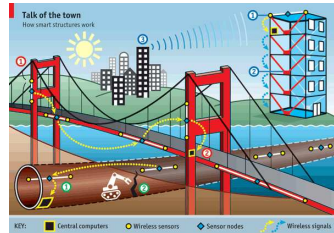

<http://www.rfwirelessensors.com>, 2012

Continuous Power / cm² vs. Life for Several Power Sources

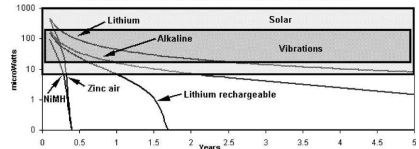

Roundy et Al.: A study of low level vibrations as a power source for wireless sensor nodes.

Objectives: Power, just where you need it



<http://enocean.com>

- Wireless
- Reduce Cost, and is reconfigurable
- Better Waste Cycle (Information from EnOcean)

Objectives: Power, just where you need it

Innowattech's systems produces power with vehicles



<http://enocean.com>

- Wireless
- Reduce Cost, and is reconfigurable
- Better Waste Cycle
(Information from Enocean)



<http://www.innowattech.com>

Objectives: Power, just where you need it

Innowattech's systems produces power with vehicles



<http://enocan.com>

- Wireless
- Reduce Cost, and is reconfigurable
- Better Waste Cycle (Information from Enoceen)



<http://www.innowattech.com>



The economist – April 28th 2007

Objectives: Marketing Purpose

Experience: Same Remote controller energized by human power, but with different packaging.

"No need for Batteries"

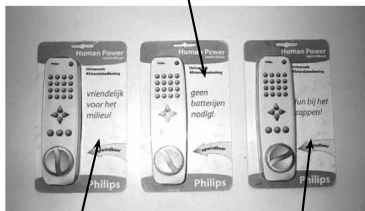

"Green"

"Fun"

Objectives: Marketing Purpose

Experience: Same Remote controller energized by human power, but with different packaging.

"No need for Batteries"

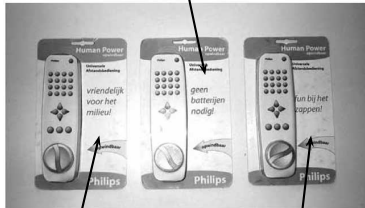

"Green"

"Fun"

54% of people Will choose the first one because it is eco-friendly.
(Jansen, Human power empirically explored)

Objectives: Marketing Purpose

Experience: Same Remote controller energized by human power, but with different packaging.

"No need for Batteries"

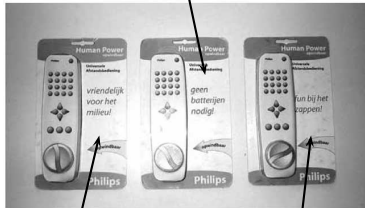

"Green"

"Fun"

54% of people Will choose the first one because it is eco-friendly.
(Jansen, Human power empirically explored)

Several projects are born from this fact: **Metis** Produces energy from dancers' movements.



In Toulouse, the system **VIHA** proposes Smart Tiles to energise street lights.



The energy converter

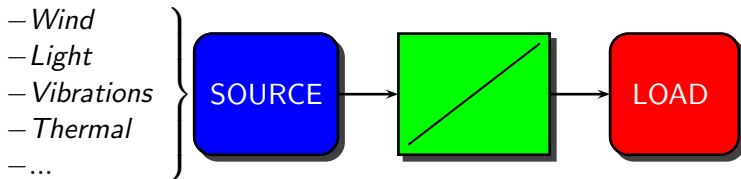

The energy converter

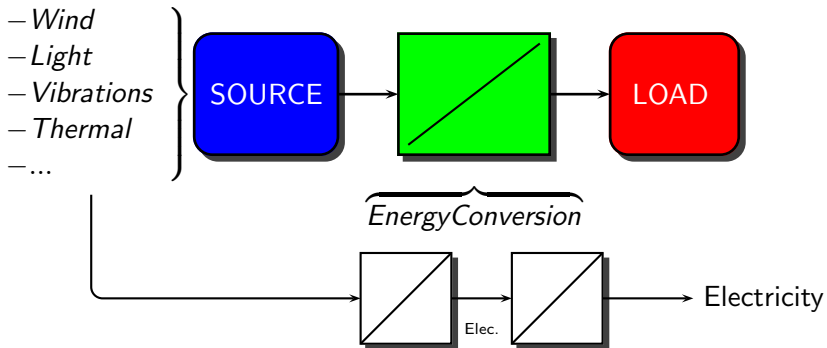

The energy converter

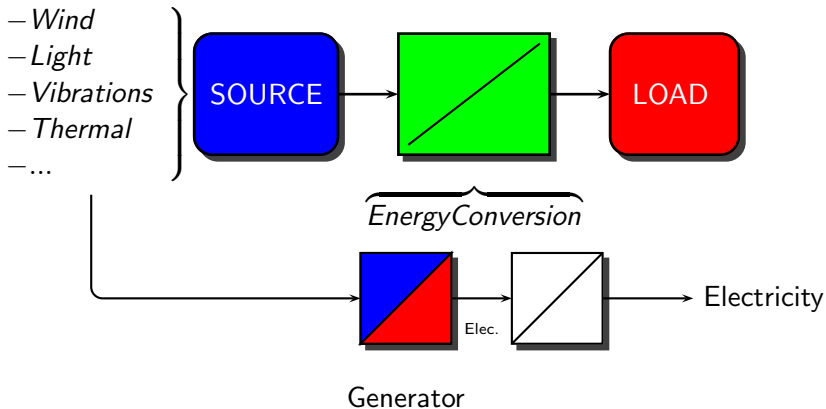

The energy converter

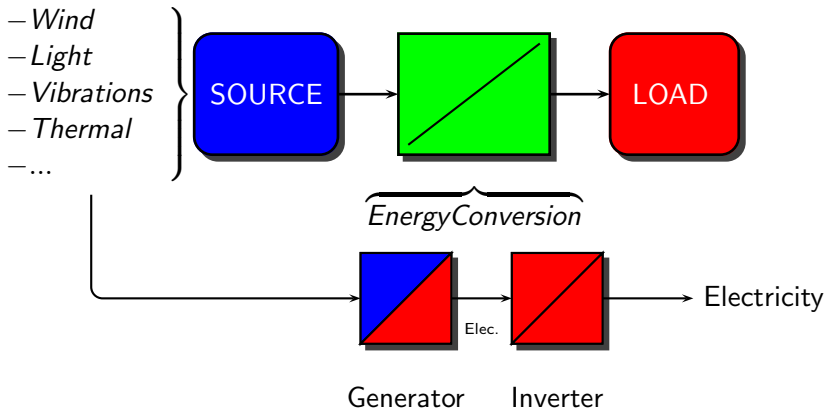

Solar Harvesters:

Solar Harvesters:

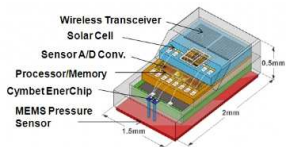

This sensor measures IntraOcular Pressure <http://cymbet.com>



Handbag to recharge electronic devices <http://www.neubers.de>

Solar Harvesters:

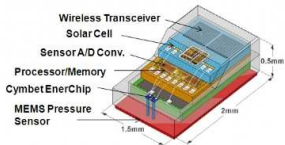

This sensor measures IntraOcular Pressure <http://cymbet.com>



Handbag to recharge electronic devices <http://www.neubers.de>

Power and current as a function of voltage:

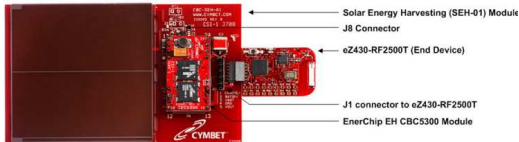
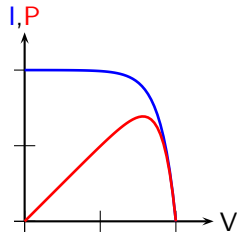

Solar Energy Harvester Evaluation Kit <http://ti.com>

Solar Harvesters:

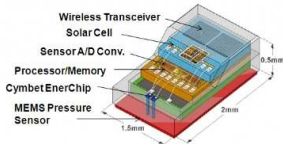

This sensor measures IntraOcular Pressure <http://cymbet.com>



Handbag to recharge electronic devices <http://www.neubers.de>

Power and current as a function of voltage:

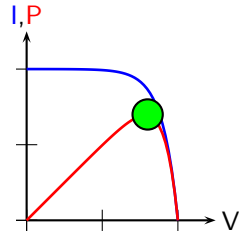

MPPT strategies, require Energy management of the system

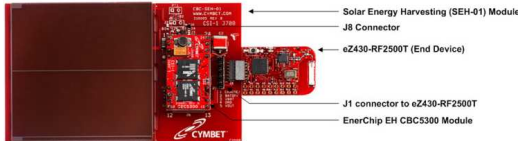

Solar Energy Harvester Evaluation Kit <http://ti.com>

Thermoelectric

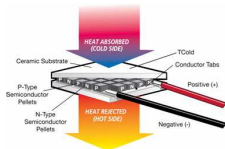

A Peltier module from <http://www.tellurex.com>

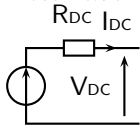

Thermoelectric

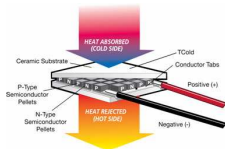

A Peltier module from <http://www.tellurex.com>

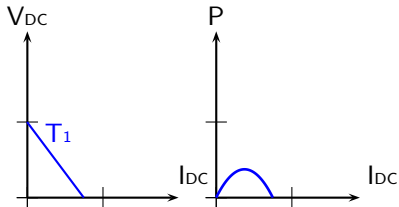
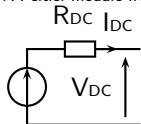

Thermoelectric

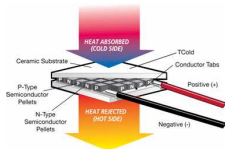

A Peltier module from <http://www.tellurex.com>

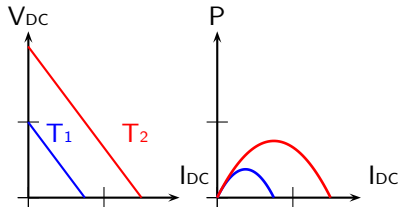
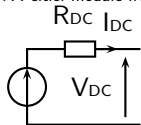

Thermoelectric

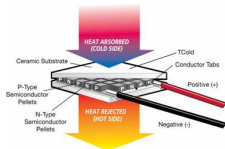

A Peltier module from <http://www.tellurex.com>

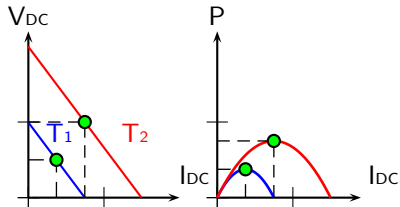
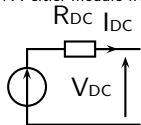

Thermoelectric

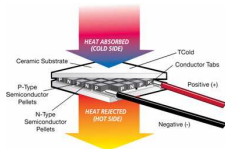

A Peltier module from <http://www.tellurex.com>

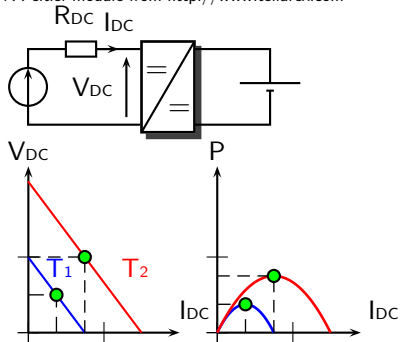

Thermoelectric

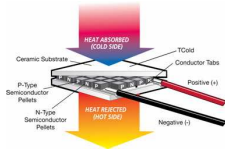

A Peltier module from <http://www.tellurex.com>

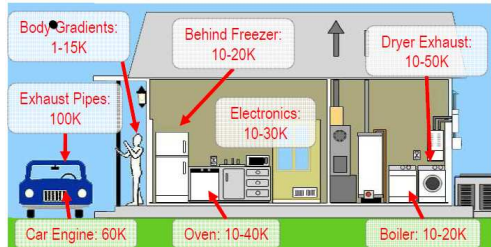
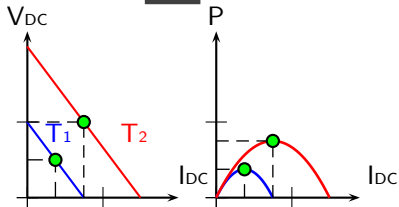
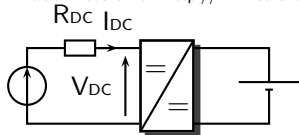

Temperature Gradient (residential). Lindsay Miller,
<http://uc-ciee.org>

Clamp-on Drain Harvester

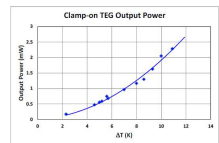

ΔT	V_{load} (mV)	P_{max} (mW)
5.0	38	0.56
8.0	55	1.16
10.0	73	2.05

plumbing application from <http://www.nextreme.com>

Magnetic

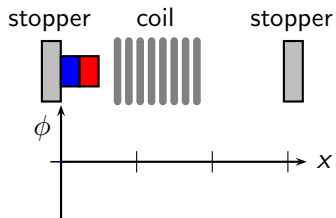

Magnetic

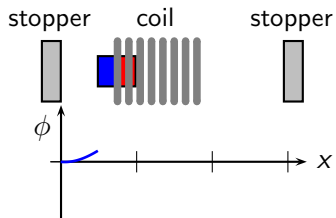

Magnetic

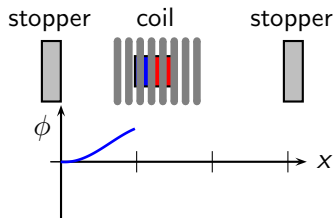

Magnetic

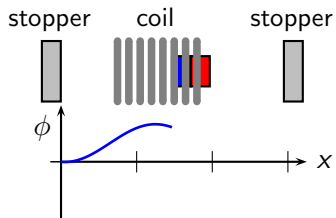

Magnetic

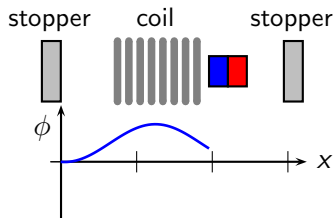

Magnetic

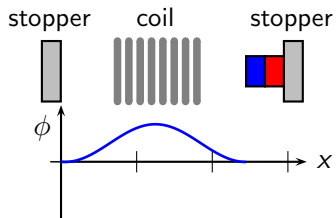

Magnetic

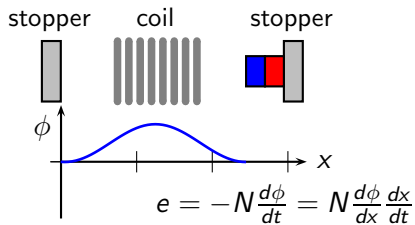

Magnetic

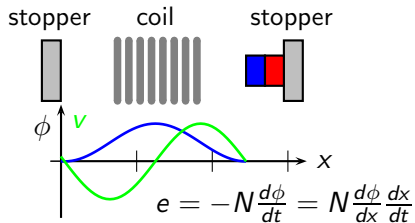

Magnetic

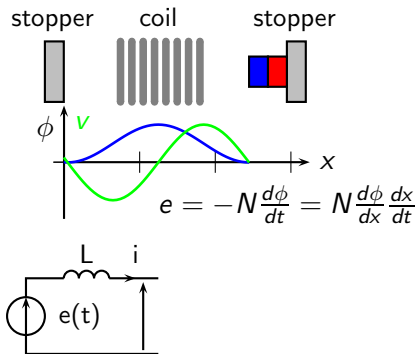

Magnetic

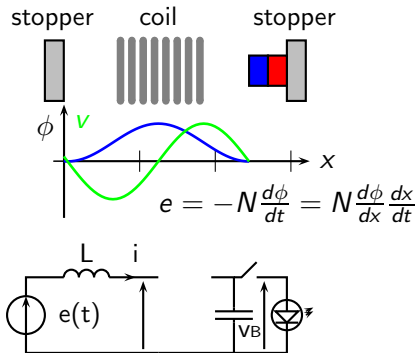

Magnetic

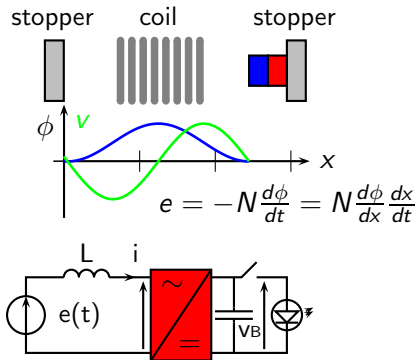

Magnetic

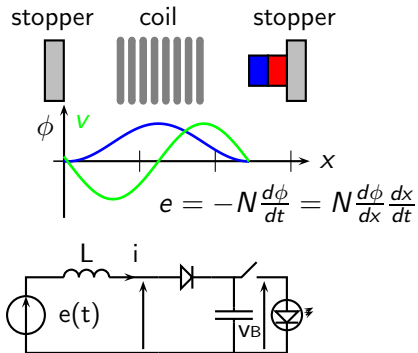

Magnetic

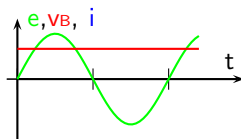
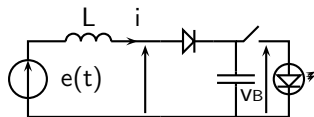
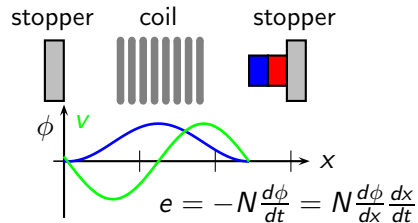

Magnetic

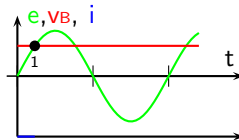
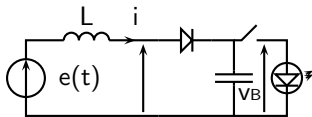
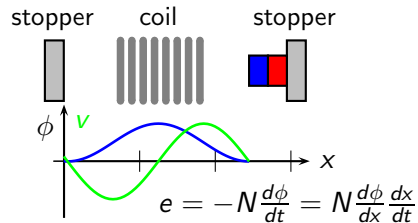

1) Diode turns ON

Magnetic

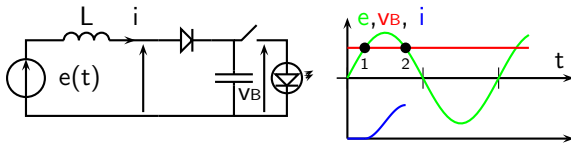
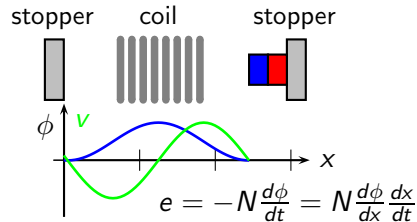

- 1) Diode turns ON
- 2) $\frac{di}{dt} = 0$ because $e - v_B = 0$



Magnetic

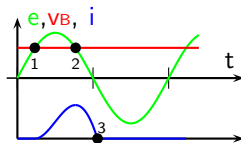
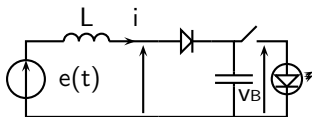
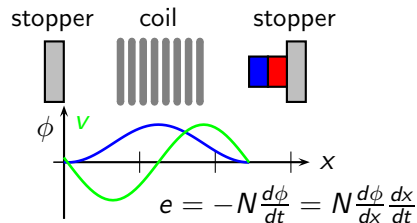

- 1) Diode turns ON
- 2) $\frac{di}{dt} = 0$ because $e - v_B = 0$
- 3) $i = 0$, diode turns OFF



Magnetic

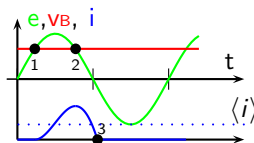
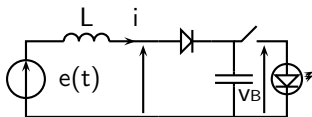
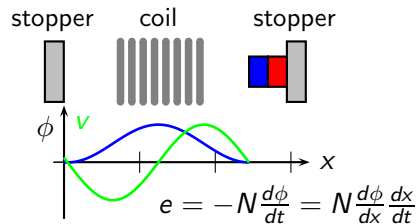

- 1) Diode turns ON
- 2) $\frac{di}{dt} = 0$ because $e - v_B = 0$
- 3) $i = 0$, diode turns OFF

Magnetic

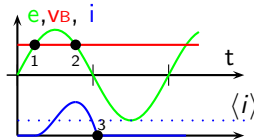
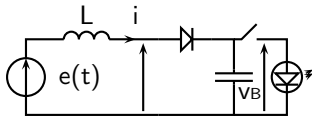
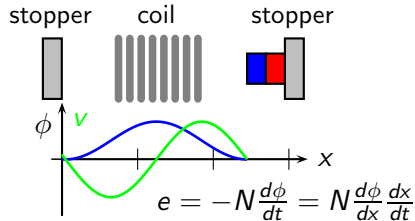

- 1) Diode turns ON
- 2) $\frac{di}{dt} = 0$ because $e - v_B = 0$
- 3) $i = 0$, diode turns OFF

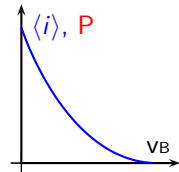

Magnetic

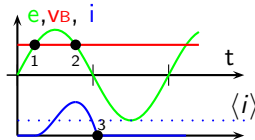
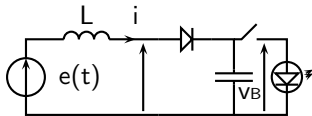
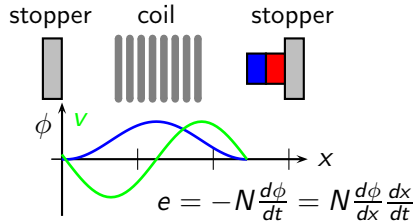

- 1) Diode turns ON
- 2) $\frac{di}{dt} = 0$ because $e - v_B = 0$
- 3) $i = 0$, diode turns OFF

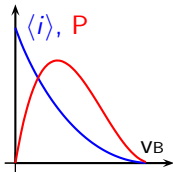

$$P = \langle v_B i \rangle = v_B \langle i \rangle$$

Magnetic

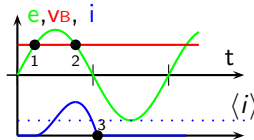
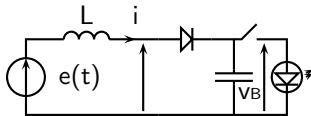
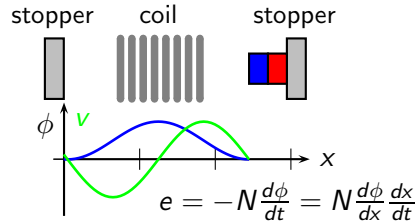

- 1) Diode turns ON
- 2) $\frac{di}{dt} = 0$ because $e - v_B = 0$
- 3) $i = 0$, diode turns OFF

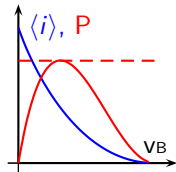

$$P = \langle v_B i \rangle = v_B \langle i \rangle$$

Magnetic

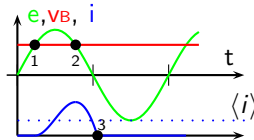
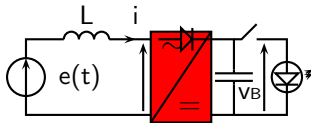
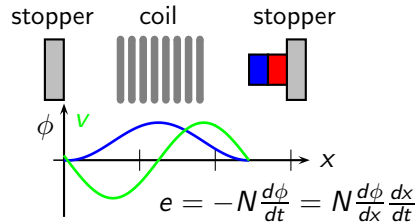

- 1) Diode turns ON
- 2) $\frac{di}{dt} = 0$ because $e - v_B = 0$
- 3) $i = 0$, diode turns OFF

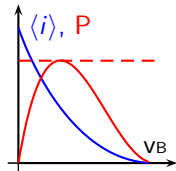

$$P = \langle v_B i \rangle = v_B \langle i \rangle$$

Piezoelectric

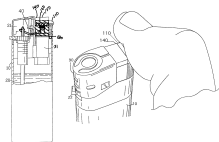

An electronic lighter,
<http://freepatentsonline.com>



Piezoelectric crystals

Piezoelectric

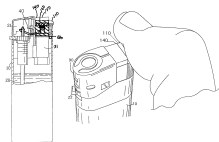

An electronic lighter,
<http://freepatentsonline.com>



Piezoelectric crystals
Cantilever beam

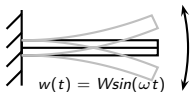

Piezoelectric

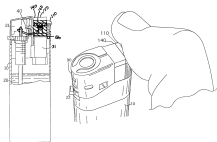

An electronic lighter,
<http://freepatentsonline.com>



Piezoelectric crystals
Cantilever beam

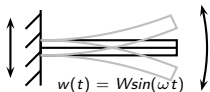

Piezoelectric

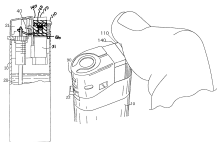

An electronic lighter,
<http://freepatentsonline.com>



Piezoelectric crystals

Cantilever beam

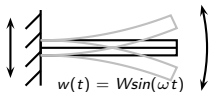

Equivalent electrical circuit

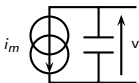

i_m is a current proportional
to the deformation speed

Piezoelectric

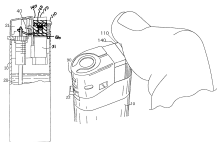

An electronic lighter,
<http://freepatentsonline.com>



Piezoelectric crystals
Cantilever beam

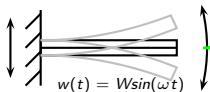

Equivalent electrical circuit

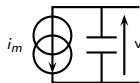

i_m is a current proportional
to the deformation speed

Piezoelectric

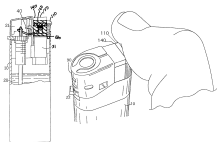

An electronic lighter,
<http://freepatentsonline.com>



Piezoelectric crystals
Cantilever beam

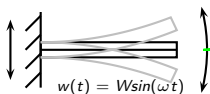

Equivalent electrical circuit

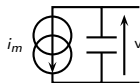

i_m is a current proportional
to the deformation speed

Comparison Magn. Piezo

Magnetic	Piezo.
Voltage source	Current source
Inductive	capacitive
Large Stroke	Small Stroke
Remote action	

Piezoelectric

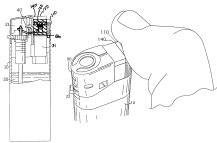

An electronic lighter,
<http://freepatentsonline.com>



Piezoelectric crystals
Cantilever beam

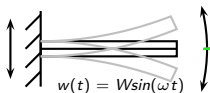

Equivalent electrical circuit

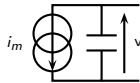

i_m is a current proportional
to the deformation speed
Comparison Magn. Piezo

Magnetic	Piezo.
Voltage source	Current source
Inductive	capacitive
Large Stroke	Small Stroke
Remote action	

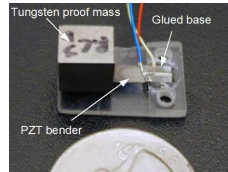

Roundy, A piezoelectric vibration based generator for wireless electronics (2004)

Piezoelectric

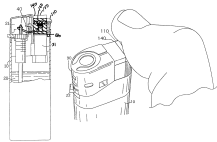

An electronic lighter,
<http://freepatentsonline.com>



Piezoelectric crystals
Cantilever beam

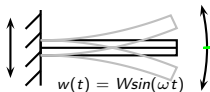

Equivalent electrical circuit

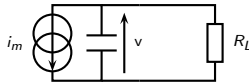

i_m is a current proportional
to the deformation speed
Comparison Magn. Piezo

Magnetic	Piezo.
Voltage source	Current source
Inductive	capacitive
Large Stroke	Small Stroke
Remote action	

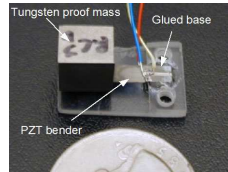

Roundy, A piezoelectric vibration based generator for wireless electronics (2004)

Piezoelectric

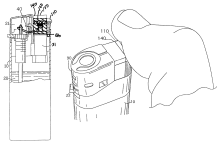

An electronic lighter,
<http://freepatentsonline.com>



Piezoelectric crystals
Cantilever beam

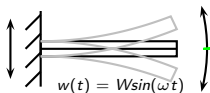

Equivalent electrical circuit

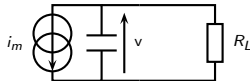

i_m is a current proportional
to the deformation speed
Comparison Magn. Piezo

Magnetic	Piezo.
Voltage source	Current source
Inductive	capacitive
Large Stroke	Small Stroke
Remote action	

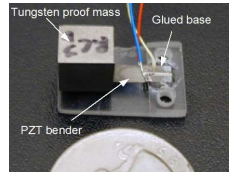

Roundy, A piezoelectric vibration based generator for wireless electronics (2004)

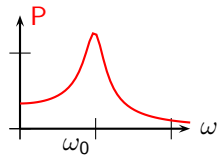

Piezoelectric

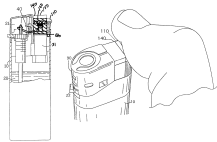

An electronic lighter,
<http://freepatentsonline.com>



Piezoelectric crystals
Cantilever beam

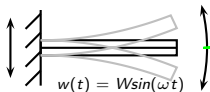

Equivalent electrical circuit

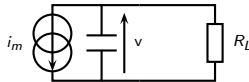

i_m is a current proportional
to the deformation speed
Comparison Magn. Piezo

Magnetic	Piezo.
Voltage source	Current source
Inductive	capacitive
Large Stroke	Small Stroke
Remote action	

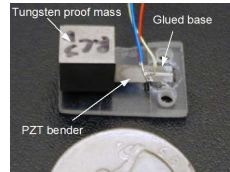

Roundy, A piezoelectric vibration based generator for wireless electronics (2004)

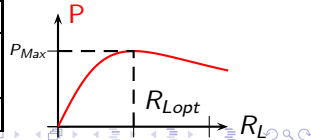
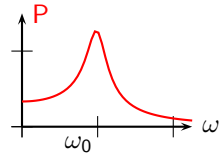

Piezoelectric

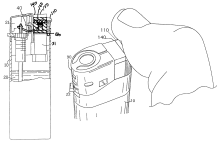

An electronic lighter,
<http://freepatentsonline.com>



Piezoelectric crystals
Cantilever beam

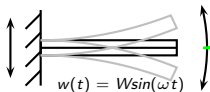

Energy Management

Equivalent electrical circuit

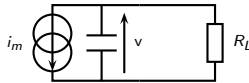

i_m is a current proportional
to the deformation speed

Comparison Magn. Piezo

Magnetic	Piezo.
Voltage source	Current source
Inductive	capacitive
Large Stroke	Small Stroke
Remote action	

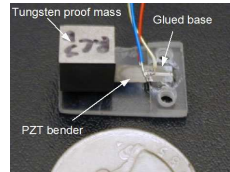

Roundy, A piezoelectric vibration based generator for wireless electronics (2004)

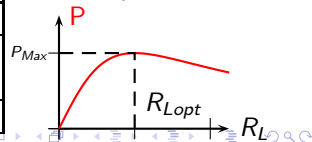
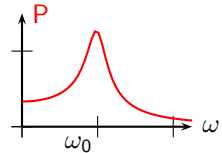

Piezoelectric

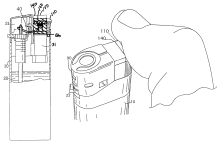

An electronic lighter,
<http://freepatentsonline.com>



Piezoelectric crystals
Cantilever beam

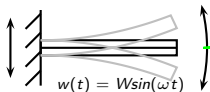

Energy Management

Equivalent electrical circuit

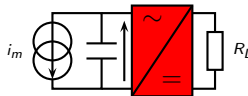

i_m is a current proportional
to the deformation speed

Comparison Magn. Piezo

Magnetic	Piezo.
Voltage source	Current source
Inductive	capacitive
Large Stroke	Small Stroke
Remote action	

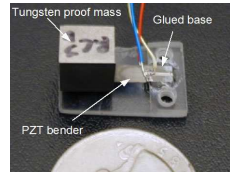

Roundy, A piezoelectric vibration based generator for wireless electronics (2004)

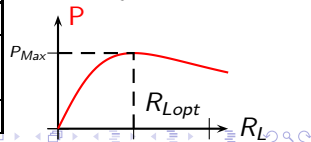
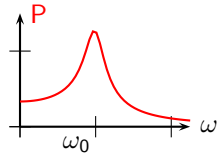

There is no "one fit all" solution

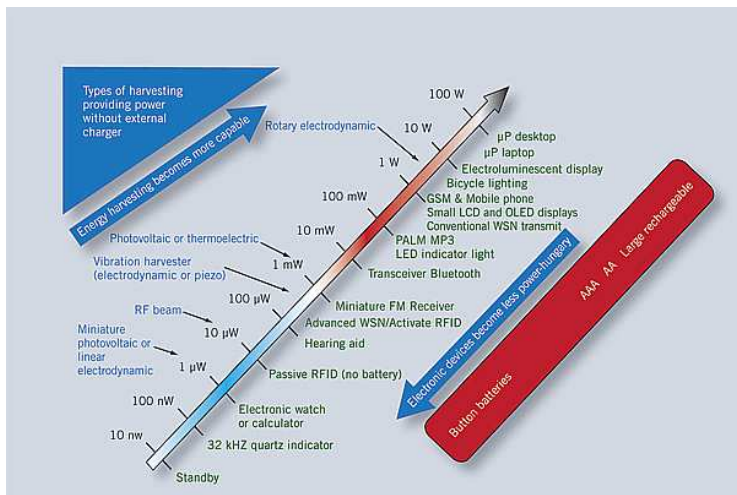

Each solution may be efficient in a certain range of Power.

Meanwhile, shrinking Chips consumption come at a time when energy harvesting becomes efficient and practical (source: IDtechex.com)

Table of contents

- 1 Introduction
 - What is Energy Harvesting ?
 - Generator Technologies
 - Summary
- 2 Modelling of a piezoelectric energy harvester
 - Presentation of the system
 - EMR of the system
 - Power Extraction on a load resistor R_L from harmonic oscillation
- 3 An Example of inverter
 - Introduction
 - SSHI: Synchronized Switch Harvesting on Inductor

Coordinates and assumptions

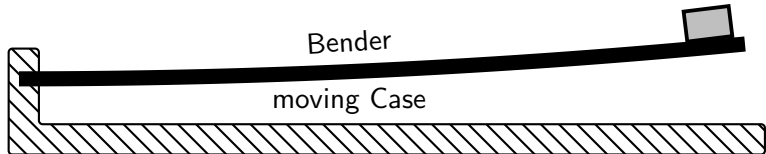

Coordinates and assumptions

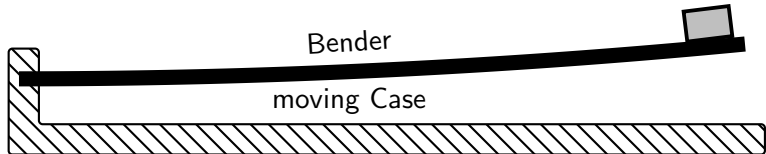

- The bender is attached to a vibrating and rigid case,

Coordinates and assumptions

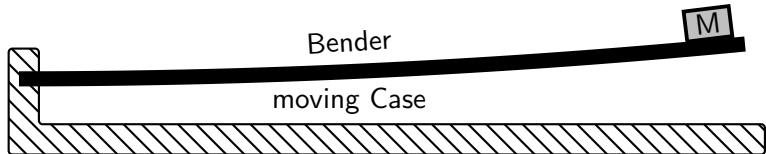

- The bender is attached to a vibrating and rigid case,
- A mass M is attached to increase power harvesting,

Coordinates and assumptions

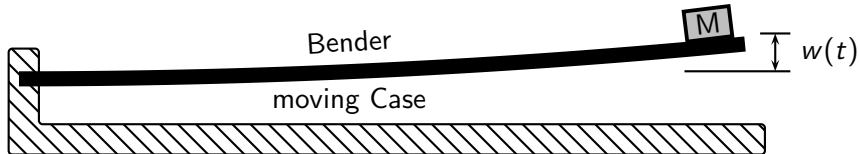

- The bender is attached to a vibrating and rigid case,
- A mass M is attached to increase power harvesting,
- $w(t)$ is the deflection of the beam,

Coordinates and assumptions

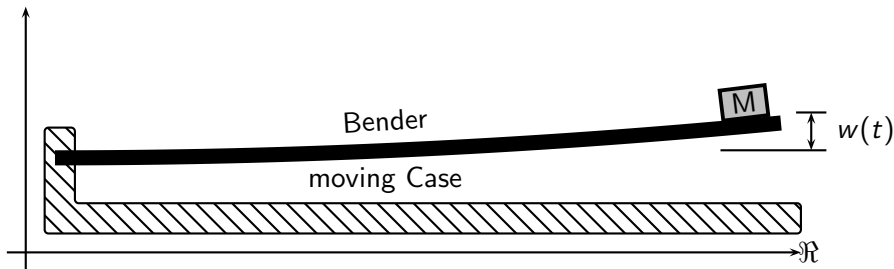

- The bender is attached to a vibrating and rigid case,
- A mass M is attached to increase power harvesting,
- $w(t)$ is the deflection of the beam,
- We define \mathcal{R} a fixed reference frame,

Coordinates and assumptions

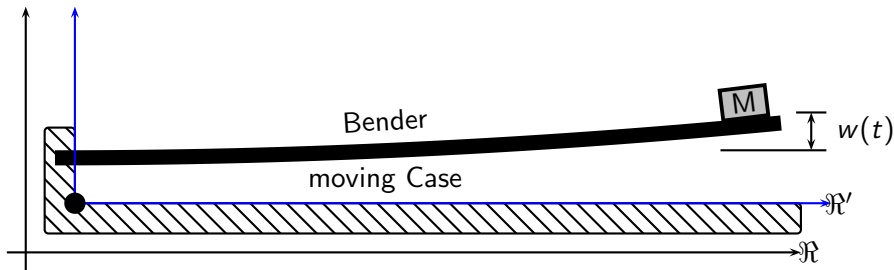

- The bender is attached to a vibrating and rigid case,
- A mass M is attached to increase power harvesting,
- $w(t)$ is the deflection of the beam,
- We define \mathcal{R} a fixed reference frame,
- And \mathcal{R}' a reference frame affixed to the vibrating case.

Coordinates and assumptions

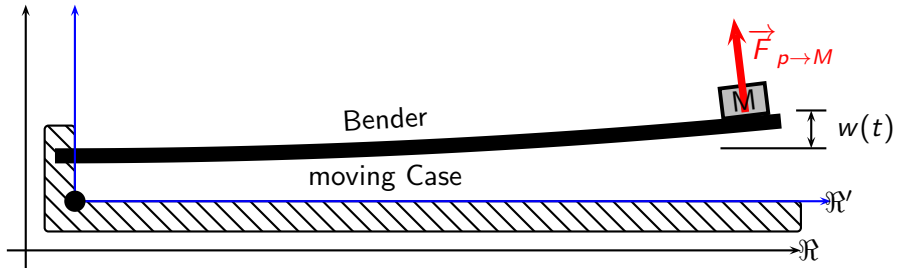

- The bender is attached to a vibrating and rigid case,
- A mass M is attached to increase power harvesting,
- $w(t)$ is the deflection of the beam,
- We define \mathcal{R} a fixed reference frame,
- And \mathcal{R}' a reference frame affixed to the vibrating case.

- $\vec{F}_{p \rightarrow m}$ is the force of the Bender onto the mass M .

Coordinates and assumptions

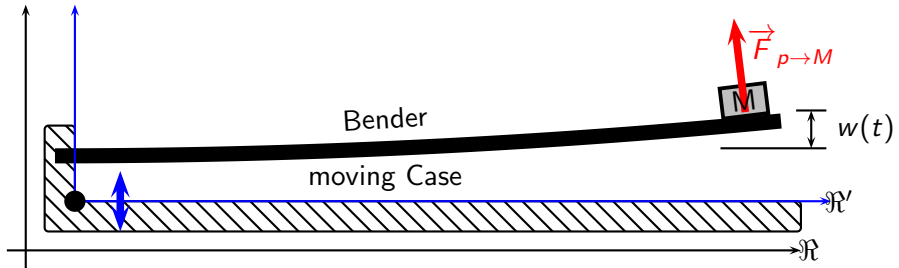

- The bender is attached to a vibrating and rigid case,
- A mass M is attached to increase power harvesting,
- $w(t)$ is the deflection of the beam,
- We define \mathcal{R} a fixed reference frame,
- And \mathcal{R}' a reference frame affixed to the vibrating case.
- $\vec{F}_{p \rightarrow m}$ is the force of the Bender onto the mass M .
- The case is supposed to be controlled in position, and we have $y_c = A \sin(\omega t)$ the amplitude of the case's vibration.

Coordinates and assumptions

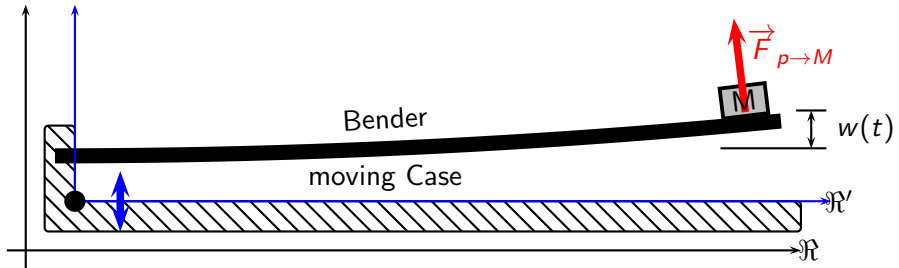

- The bender is attached to a vibrating and rigid case,
- A mass M is attached to increase power harvesting,
- $w(t)$ is the deflection of the beam,
- We define \mathcal{R} a fixed reference frame,
- And \mathcal{R}' a reference frame affixed to the vibrating case.
- $\vec{F}_{p \rightarrow m}$ is the force of the Bender onto the mass M .
- The case is supposed to be controlled in position, and we have $y_c = A \sin(\omega t)$ the amplitude of the case's vibration.
- Gravity is neglected, as well as Inertia momentum of the bender,

Coordinates and assumptions

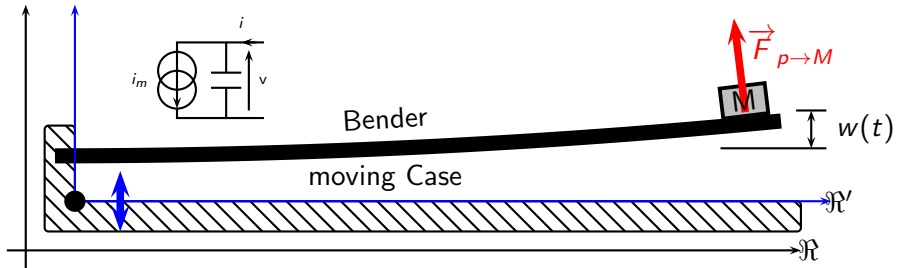

- The bender is attached to a vibrating and rigid case,
- A mass M is attached to increase power harvesting,
- $w(t)$ is the deflection of the beam,
- We define \mathcal{R} a fixed reference frame,
- And \mathcal{R}' a reference frame affixed to the vibrating case.
- $\vec{F}_{p \rightarrow m}$ is the force of the Bender onto the mass M .
- The case is supposed to be controlled in position, and we have $y_c = A \sin(\omega t)$ the amplitude of the case's vibration.
- Gravity is neglected, as well as Inertia momentum of the bender,
- Actuator electrical convention.

Equations

- **Dynamic of the mass M :**

Glossary

- M the mass
- f , the force onto M
- A , vibration's amplitude
- ω , vibration's pulsation
- f_{acc} is the inertial force
- i current of the device (actuator convention)
- i_m motional current
- f_p inside piezo force
- N Piezoelectric force factor (depends on geometry)
- f_p Piezo internal force
- f_s Material internal elastic force
- K_s equivalent stiffness (depends on geometry)
- D_s Viscous coefficient

Equations

- **Dynamic of the mass M :**

- $M \frac{d^2}{dt^2} (w(t) + A \sin(\omega t)) = F_{p \rightarrow M} = f$

Glossary

- M the mass
- f , the force onto M
- A , vibration's amplitude
- ω , vibration's pulsation
- f_{acc} is the inertial force
- i current of the device (actuator convention)
- i_m motional current
- f_p inside piezo force
- N Piezoelectric force factor (depends on geometry)
- f_p Piezo internal force
- f_s Material internal elastic force
- K_s equivalent stiffness (depends on geometry)
- D_s Viscous coefficient

Equations

• Dynamic of the mass M :

- $M \frac{d^2}{dt^2} (w(t) + A \sin(\omega t)) = F_{p \rightarrow M} = f$
- $M \ddot{w}(t) = f + MA\omega^2 \sin(\omega t) = f + f_{acc}$

Glossary

- M the mass
- f , the force onto M
- A , vibration's amplitude
- ω , vibration's pulsation
- f_{acc} is the inertial force
- i current of the device (actuator convention)
- i_m motional current
- f_p inside piezo force
- N Piezoelectric force factor (depends on geometry)
- f_p Piezo internal force
- f_s Material internal elastic force
- K_s equivalent stiffness (depends on geometry)
- D_s Viscous coefficient

Equations

- **Dynamic of the mass M :**

- $M \frac{d^2}{dt^2} (w(t) + A \sin(\omega t)) = F_{p \rightarrow M} = f$
- $M \ddot{w}(t) = f + MA\omega^2 \sin(\omega t) = f + f_{acc}$

- **Electrical Behaviour:** Capacitive

Glossary

- M the mass
- f , the force onto M
- A , vibration's amplitude
- ω , vibration's pulsation
- f_{acc} is the inertial force
- i current of the device (actuator convention)
- i_m motional current
- f_p inside piezo force
- N Piezoelectric force factor (depends on geometry)
- f_p Piezo internal force
- f_s Material internal elastic force
- K_s equivalent stiffness (depends on geometry)
- D_s Viscous coefficient

Equations

- **Dynamic of the mass M :**

- $M \frac{d^2}{dt^2} (w(t) + A \sin(\omega t)) = F_{p \rightarrow M} = f$
- $M \ddot{w}(t) = f + MA\omega^2 \sin(\omega t) = f + f_{acc}$

- **Electrical Behaviour:** Capacitive

- $v = \frac{1}{C_b} \int (i - i_m) dt$

Glossary

- M the mass
- f , the force onto M
- A , vibration's amplitude
- ω , vibration's pulsation
- f_{acc} is the inertial force
- i current of the device (actuator convention)
- i_m motional current
- f_p inside piezo force
- N Piezoelectric force factor (depends on geometry)
- f_p Piezo internal force
- f_s Material internal elastic force
- K_s equivalent stiffness (depends on geometry)
- D_s Viscous coefficient

Equations

- **Dynamic of the mass M :**

- $M \frac{d^2}{dt^2} (w(t) + A \sin(\omega t)) = F_{p \rightarrow M} = f$
- $M \ddot{w}(t) = f + MA\omega^2 \sin(\omega t) = f + f_{acc}$

- **Electrical Behaviour:** Capacitive

- $v = \frac{1}{C_b} \int (i - i_m) dt$

- **Piezoelectric effect**

Glossary

- M the mass
- f , the force onto M
- A , vibration's amplitude
- ω , vibration's pulsation
- f_{acc} is the inertial force
- i current of the device (actuator convention)
- i_m motional current
- f_p inside piezo force
- N Piezoelectric force factor (depends on geometry)
- f_p Piezo internal force
- f_s Material internal elastic force
- K_s equivalent stiffness (depends on geometry)
- D_s Viscous coefficient

Equations

- **Dynamic of the mass M :**

- $M \frac{d^2}{dt^2} (w(t) + A \sin(\omega t)) = F_{p \rightarrow M} = f$
- $M \ddot{w}(t) = f + MA\omega^2 \sin(\omega t) = f + f_{acc}$

- **Electrical Behaviour:** Capacitive

- $v = \frac{1}{C_b} \int (i - i_m) dt$

- **Piezoelectric effect**

- i_m derives from deflection: $i_m = N \dot{w}$

Glossary

- M the mass
- f , the force onto M
- A , vibration's amplitude
- ω , vibration's pulsation
- f_{acc} is the inertial force
- i current of the device (actuator convention)
- i_m motional current
- f_p inside piezo force
- N Piezoelectric force factor (depends on geometry)
- f_p Piezo internal force
- f_s Material internal elastic force
- K_s equivalent stiffness (depends on geometry)
- D_s Viscous coefficient

Equations

• Dynamic of the mass M :

- $M \frac{d^2}{dt^2} (w(t) + A \sin(\omega t)) = F_{p \rightarrow M} = f$
- $M \ddot{w}(t) = f + MA\omega^2 \sin(\omega t) = f + f_{acc}$

• Electrical Behaviour: Capacitive

- $v = \frac{1}{C_b} \int (i - i_m) dt$

• Piezoelectric effect

- i_m derives from deflection: $i_m = N \dot{w}$
- while v produces an internal force
 $f_p = Nv$

Glossary

- M the mass
- f , the force onto M
- A , vibration's amplitude
- ω , vibration's pulsation
- f_{acc} is the inertial force
- i current of the device (actuator convention)
- i_m motional current
- f_p inside piezo force
- N Piezoelectric force factor (depends on geometry)
- f_p Piezo internal force
- f_s Material internal elastic force
- K_s equivalent stiffness (depends on geometry)
- D_s Viscous coefficient

Equations

• Dynamic of the mass M :

- $M \frac{d^2}{dt^2} (w(t) + A \sin(\omega t)) = F_{p \rightarrow M} = f$
- $M \ddot{w}(t) = f + MA\omega^2 \sin(\omega t) = f + f_{acc}$

• Electrical Behaviour: Capacitive

- $v = \frac{1}{C_b} \int (i - i_m) dt$

• Piezoelectric effect

- i_m derives from deflection: $i_m = N \dot{w}$
- while v produces an internal force
 $f_p = Nv$

• Material's behaviour

Glossary

- M the mass
- f , the force onto M
- A , vibration's amplitude
- ω , vibration's pulsation
- f_{acc} is the inertial force
- i current of the device (actuator convention)
- i_m motional current
- f_p inside piezo force
- N Piezoelectric force factor (depends on geometry)
- f_p Piezo internal force
- f_s Material internal elastic force
- K_s equivalent stiffness (depends on geometry)
- D_s Viscous coefficient

Equations

• Dynamic of the mass M :

- $M \frac{d^2}{dt^2} (w(t) + A \sin(\omega t)) = F_{p \rightarrow M} = f$
- $M \ddot{w}(t) = f + MA\omega^2 \sin(\omega t) = f + f_{acc}$

• Electrical Behaviour: Capacitive

- $v = \frac{1}{C_b} \int (i - i_m) dt$

• Piezoelectric effect

- i_m derives from deflection: $i_m = N \dot{w}$
- while v produces an internal force
 $f_p = Nv$

• Material's behaviour

- The material is elastic: $f_s = K_s \int \dot{w} dt$

Glossary

- M the mass
- f , the force onto M
- A , vibration's amplitude
- ω , vibration's pulsation
- f_{acc} is the inertial force
- i current of the device (actuator convention)
- i_m motional current
- f_p inside piezo force
- N Piezoelectric force factor (depends on geometry)
- f_p Piezo internal force
- f_s Material internal elastic force
- K_s equivalent stiffness (depends on geometry)
- D_s Viscous coefficient

Equations

• Dynamic of the mass M :

- $M \frac{d^2}{dt^2} (w(t) + A \sin(\omega t)) = F_{p \rightarrow M} = f$
- $M \ddot{w}(t) = f + MA\omega^2 \sin(\omega t) = f + f_{acc}$

• Electrical Behaviour: Capacitive

- $v = \frac{1}{C_b} \int (i - i_m) dt$

• Piezoelectric effect

- i_m derives from deflection: $i_m = N \dot{w}$
- while v produces an internal force
 $f_p = Nv$

• Material's behaviour

- The material is elastic: $f_s = K_s \int \dot{w} dt$
- With some friction inside:
 $f_s = K_s \int \dot{w} dt + D_s \dot{w}$

Glossary

- M the mass
- f , the force onto M
- A , vibration's amplitude
- ω , vibration's pulsation
- f_{acc} is the inertial force
- i current of the device (actuator convention)
- i_m motional current
- f_p inside piezo force
- N Piezoelectric force factor (depends on geometry)
- f_p Piezo internal force
- f_s Material internal elastic force
- K_s equivalent stiffness (depends on geometry)
- D_s Viscous coefficient

Equations

• Dynamic of the mass M :

- $M \frac{d^2}{dt^2} (w(t) + A \sin(\omega t)) = F_{p \rightarrow M} = f$
- $M \ddot{w}(t) = f + MA\omega^2 \sin(\omega t) = f + f_{acc}$

• Electrical Behaviour: Capacitive

- $v = \frac{1}{C_b} \int (i - i_m) dt$

• Piezoelectric effect

- i_m derives from deflection: $i_m = N \dot{w}$
- while v produces an internal force
 $f_p = Nv$

• Material's behaviour

- The material is elastic: $f_s = K_s \int \dot{w} dt$
- With some friction inside:
 $f_s = K_s \int \dot{w} dt + D_s \dot{w}$
- These actions are opposite to the PE effect: $f = f_p - f_s$

Glossary

- M the mass
- f , the force onto M
- A , vibration's amplitude
- ω , vibration's pulsation
- f_{acc} is the inertial force
- i current of the device (actuator convention)
- i_m motional current
- f_p inside piezo force
- N Piezoelectric force factor (depends on geometry)
- f_p Piezo internal force
- f_s Material internal elastic force
- K_s equivalent stiffness (depends on geometry)
- D_s Viscous coefficient

EMR of the system

$$v = \frac{1}{C_b} \int (i - i_m) dt$$



EMR of the system

$$v = \frac{1}{C_b} \int (i - i_m) dt$$

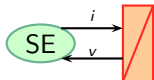

EMR of the system

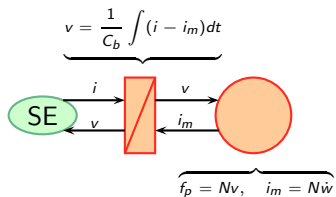

EMR of the system

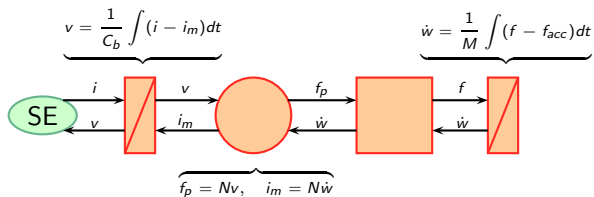

EMR of the system

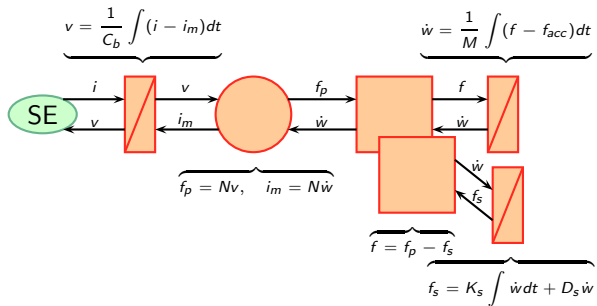

EMR of the system

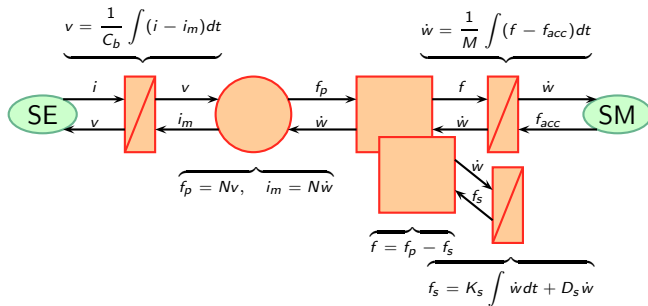

EMR of the system

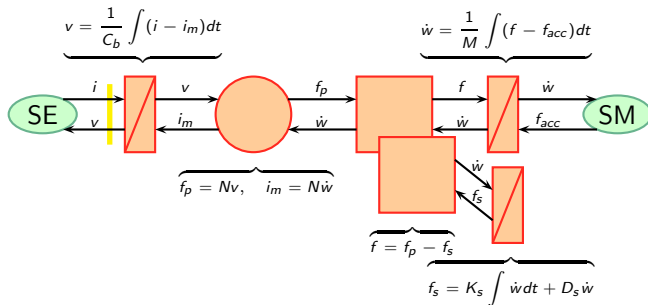

$p_e = v \cdot i$ is the output power,

EMR of the system

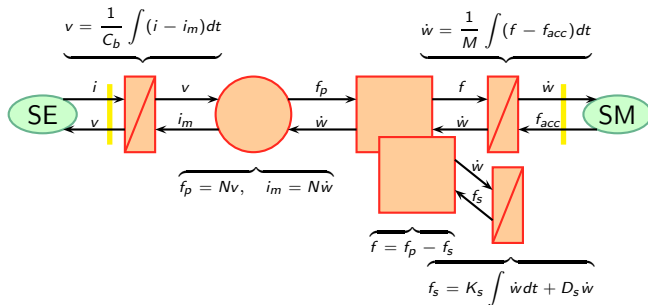

$p_e = v \cdot i$ is the output power, $p_m = f_{acc} \dot{w}$ is the mechanical input power and both should be < 0

EMR of the system

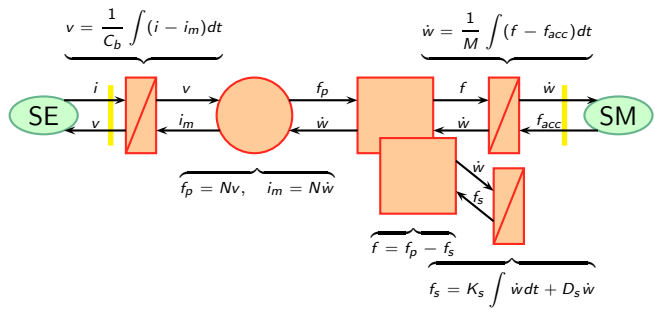

$p_e = v \cdot i$ is the output power, $p_m = f_{acc} \dot{w}$ is the mechanical input power and both should be < 0

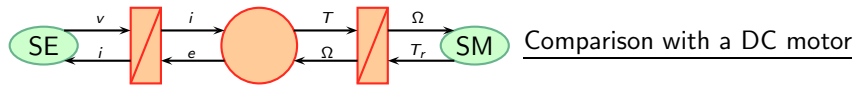

Things are not so different.

EMR of the system

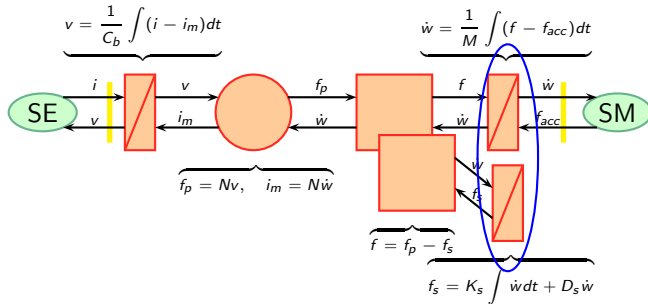

$p_e = v \cdot i$ is the output power, $p_m = f_{acc} \dot{w}$ is the mechanical input power and both should be < 0

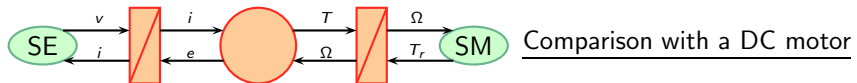

Things are not so different.

Asumption

- $f_{acc} = MA\omega^2 \sin(\omega t)$ for harmonic oscillations

Asumption

- $f_{acc} = MA\omega^2 \sin(\omega t)$ for harmonic oscillations
- complex notation: \underline{x} is the complex phasor of $x(t)$, means $x(t) = \Im(\underline{x})$

Asumption

- $f_{acc} = MA\omega^2 \sin(\omega t)$ for harmonic oscillations
- complex notation: \underline{x} is the complex phasor of $x(t)$, means $x(t) = \Im(\underline{x})$
- since oscillations are harmonic, we will write: $\underline{x} = \underline{X}e^{j\omega t}$

Asumption

- $f_{acc} = MA\omega^2 \sin(\omega t)$ for harmonic oscillations
- complex notation: \underline{x} is the complex phasor of $x(t)$, means $x(t) = \Im(\underline{x})$
- since oscillations are harmonic, we will write: $\underline{x} = \underline{X}e^{j\omega t}$
- for steady state operation, \underline{X} is constant, leading to $\frac{dx}{dt} = j\omega \underline{X}e^{j\omega t}$

Assumption

- $f_{acc} = MA\omega^2 \sin(\omega t)$ for harmonic oscillations
- complex notation: \underline{x} is the complex phasor of $x(t)$, means $x(t) = \Im(\underline{x})$
- since oscillations are harmonic, we will write: $\underline{x} = \underline{X}e^{j\omega t}$
- for steady state operation, \underline{X} is constant, leading to $\frac{dx}{dt} = j\omega \underline{X}e^{j\omega t}$
- $|\underline{x}| = |\underline{X}| = X$

Assumption

- $f_{acc} = MA\omega^2 \sin(\omega t)$ for harmonic oscillations
- complex notation: \underline{x} is the complex phasor of $x(t)$, means $x(t) = \Im(\underline{x})$
- since oscillations are harmonic, we will write: $\underline{x} = \underline{X}e^{j\omega t}$
- for steady state operation, \underline{X} is constant, leading to $\frac{dx}{dt} = j\omega \underline{X}e^{j\omega t}$
- $|\underline{x}| = |\underline{X}| = X$
- for example, $\underline{f}_{acc} = MA\omega^2 e^{j\omega t}$ and $|\underline{f}_{acc}| = MA\omega^2$.

Assumption

- $f_{acc} = MA\omega^2 \sin(\omega t)$ for harmonic oscillations
- complex notation: \underline{x} is the complex phasor of $x(t)$, means $x(t) = \Im(\underline{x})$
- since oscillations are harmonic, we will write: $\underline{x} = \underline{X}e^{j\omega t}$
- for steady state operation, \underline{X} is constant, leading to $\frac{dx}{dt} = j\omega \underline{X}e^{j\omega t}$
- $|\underline{x}| = |\underline{X}| = X$
- for example, $\underline{f}_{acc} = MA\omega^2 e^{j\omega t}$ and $|\underline{f}_{acc}| = MA\omega^2$.
- $v = -R_L i$

Assumption

- $f_{acc} = MA\omega^2 \sin(\omega t)$ for harmonic oscillations
- complex notation: \underline{x} is the complex phasor of $x(t)$, means $x(t) = \Im(\underline{x})$
- since oscillations are harmonic, we will write: $\underline{x} = \underline{X}e^{j\omega t}$
- for steady state operation, \underline{X} is constant, leading to $\frac{dx}{dt} = j\omega \underline{X}e^{j\omega t}$
- $|\underline{x}| = |\underline{X}| = X$
- for example, $\underline{f}_{acc} = MA\omega^2 e^{j\omega t}$ and $|\underline{f}_{acc}| = MA\omega^2$.
- $v = -R_L i$

Assumption

- $f_{acc} = MA\omega^2 \sin(\omega t)$ for harmonic oscillations
- complex notation: \underline{x} is the complex phasor of $x(t)$, means $x(t) = \Im(\underline{x})$
- since oscillations are harmonic, we will write: $\underline{x} = \underline{X}e^{j\omega t}$
- for steady state operation, \underline{X} is constant, leading to $\frac{dx}{dt} = j\omega \underline{X}e^{j\omega t}$
- $|\underline{x}| = |\underline{X}| = X$
- for example, $\underline{f}_{acc} = MA\omega^2 e^{j\omega t}$ and $|\underline{f}_{acc}| = MA\omega^2$.
- $v = -R_L i$

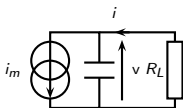

Assumption

- $f_{acc} = MA\omega^2 \sin(\omega t)$ for harmonic oscillations
- complex notation: \underline{x} is the complex phasor of $x(t)$, means $x(t) = \Im(\underline{x})$
- since oscillations are harmonic, we will write: $\underline{x} = \underline{X}e^{j\omega t}$
- for steady state operation, \underline{X} is constant, leading to $\frac{d\underline{x}}{dt} = j\omega \underline{X}e^{j\omega t}$
- $|\underline{x}| = |\underline{X}| = X$
- for example, $\underline{f}_{acc} = MA\omega^2 e^{j\omega t}$ and $|\underline{f}_{acc}| = MA\omega^2$.
- $v = -R_L i$

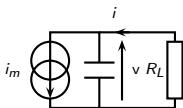

And $R_L \ll \frac{1}{C_b\omega}$, yields
 $v \simeq -R_L i_m$

For an ideal generator ($D_s = 0$)

- $M\ddot{w} = \underline{f} + \underline{f}_{acc}$

For an ideal generator ($D_s = 0$)

- $M\ddot{\underline{w}} = \underline{f} + \underline{f}_{acc}$
- $\underline{f} = N\underline{v} - K_s\underline{w}$

For an ideal generator ($D_s = 0$)

- $M\ddot{w} = \underline{f} + \underline{f}_{acc}$
- $\underline{f} = N\underline{v} - K_s\underline{w}$
- $\underline{v} = -R_L\underline{i}_m = -R_L N\dot{w}$

For an ideal generator ($D_s = 0$)

- $M\ddot{w} = \underline{f} + \underline{f}_{acc}$
- $\underline{f} = N\underline{v} - K_s\underline{w}$
- $\underline{v} = -R_L\underline{i}_m = -R_L N\dot{w}$
- $M\ddot{w} + N^2 R_L \dot{w} + K_s w = \underline{f}_{acc}$

For an ideal generator ($D_s = 0$)

- $M\ddot{w} = \underline{f} + \underline{f}_{acc}$
- $\underline{f} = N\underline{v} - K_s\underline{w}$
- $\underline{v} = -R_L\underline{i}_m = -R_L N\dot{w}$
- $M\ddot{w} + N^2 R_L \dot{w} + K_s w = \underline{f}_{acc}$
→ R_L acts as a damping
- $P_2 = -\frac{1}{2}R_L|i_m|^2$

For an ideal generator ($D_s = 0$)

- $M\ddot{w} = \underline{f} + \underline{f}_{acc}$
- $\underline{f} = N\underline{v} - K_s\underline{w}$
- $\underline{v} = -R_L\underline{i}_m = -R_L N\dot{w}$
- $M\ddot{w} + N^2 R_L \dot{w} + K_s w = \underline{f}_{acc}$
→ R_L acts as a damping
- $|i_m| = N|\dot{w}| = \frac{\omega \cdot N \cdot |f_{acc}|}{\sqrt{(K_s - M\omega^2)^2 + (N^2 R_L \omega)^2}}$

For an ideal generator ($D_s = 0$)

- $M\ddot{w} = \underline{f} + \underline{f}_{acc}$
- $\underline{f} = N\underline{v} - K_s\underline{w}$
- $\underline{v} = -R_L\underline{i}_m = -R_L N\dot{w}$
- $M\ddot{w} + N^2 R_L \dot{w} + K_s w = \underline{f}_{acc}$
 $\rightarrow R_L$ acts as a damping
- $P_2 = -\frac{1}{2} R_L |i_m|^2$
- $|i_m| = N|\dot{w}| = \frac{\omega \cdot N \cdot |f_{acc}|}{\sqrt{(K_s - M\omega^2)^2 + (N^2 R_L \omega)^2}}$
- $P_2 = -\frac{1}{2} \frac{N^2 R_L \omega^2 |f_{acc}|^2}{(K_s - M\omega^2)^2 + (N^2 R_L \omega)^2}$

For an ideal generator ($D_s = 0$)

- $M\ddot{w} = \underline{f} + \underline{f}_{acc}$
- $\underline{f} = N\underline{v} - K_s\underline{w}$
- $\underline{v} = -R_L\underline{i}_m = -R_L N\dot{w}$
- $M\ddot{w} + N^2 R_L \dot{w} + K_s w = \underline{f}_{acc}$
 $\rightarrow R_L$ acts as a damping
- $P_2 = -\frac{1}{2} R_L |i_m|^2$
- $|i_m| = N|\dot{w}| = \frac{\omega \cdot N \cdot |f_{acc}|}{\sqrt{(K_s - M\omega^2)^2 + (N^2 R_L \omega)^2}}$
- $P_2 = -\frac{1}{2} \frac{N^2 R_L \omega^2 |f_{acc}|^2}{(K_s - M\omega^2)^2 + (N^2 R_L \omega)^2}$

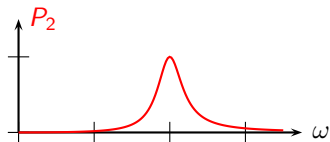

For an ideal generator ($D_s = 0$)

- $M\ddot{w} = \underline{f} + \underline{f}_{acc}$
- $\underline{f} = N\underline{v} - K_s\underline{w}$
- $\underline{v} = -R_L\underline{i}_m = -R_L N\dot{w}$
- $M\ddot{w} + N^2 R_L \dot{w} + K_s w = \underline{f}_{acc}$
 $\rightarrow R_L$ acts as a damping
- $P_2 = -\frac{1}{2} R_L |i_m|^2$
- $|i_m| = N|\dot{w}| = \frac{\omega \cdot N \cdot |f_{acc}|}{\sqrt{(K_s - M\omega^2)^2 + (N^2 R_L \omega)^2}}$
- $P_2 = -\frac{1}{2} \frac{N^2 R_L \omega^2 |f_{acc}|^2}{(K_s - M\omega^2)^2 + (N^2 R_L \omega)^2}$

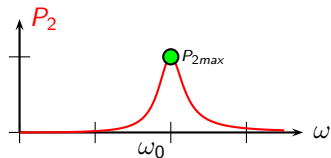

For an ideal generator ($D_s = 0$)

- $M\ddot{w} = \underline{f} + \underline{f}_{acc}$
- $\underline{f} = N\underline{v} - K_s\underline{w}$
- $\underline{v} = -R_L\underline{i}_m = -R_L N\dot{w}$
- $M\ddot{w} + N^2 R_L \dot{w} + K_s w = \underline{f}_{acc}$
 $\rightarrow R_L$ acts as a damping
- $P_2 = -\frac{1}{2} R_L |i_m|^2$
- $|i_m| = N|\dot{w}| = \frac{\omega \cdot N \cdot |f_{acc}|}{\sqrt{(K_s - M\omega^2)^2 + (N^2 R_L \omega)^2}}$
- $P_2 = -\frac{1}{2} \frac{N^2 R_L \omega^2 |f_{acc}|^2}{(K_s - M\omega^2)^2 + (N^2 R_L \omega)^2}$

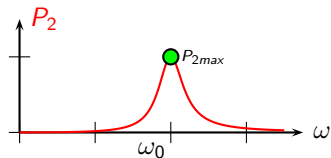

The vibrations should occur at generator's resonance frequency

$$\omega_0 = \sqrt{\frac{K_s}{M}}$$

For an ideal generator ($D_s = 0$)

- $M\ddot{w} = \underline{f} + \underline{f}_{acc}$
- $\underline{f} = N\underline{v} - K_s\underline{w}$
- $\underline{v} = -R_L\underline{i}_m = -R_L N\dot{w}$
- $M\ddot{w} + N^2 R_L \dot{w} + K_s w = \underline{f}_{acc}$
→ R_L acts as a damping
- $P_2 = -\frac{1}{2} R_L |i_m|^2$
- $|i_m| = N|\dot{w}| = \frac{\omega \cdot N \cdot |f_{acc}|}{\sqrt{(K_s - M\omega^2)^2 + (N^2 R_L \omega)^2}}$
- $P_2 = -\frac{1}{2} \frac{N^2 R_L \omega^2 |f_{acc}|^2}{(K_s - M\omega^2)^2 + (N^2 R_L \omega)^2}$

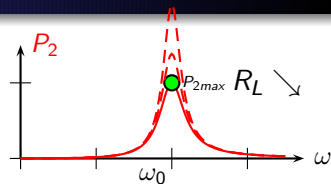

The vibrations should occur at generator's resonance frequency

$$\omega_0 = \sqrt{\frac{K_s}{M}}$$

For an ideal generator ($D_s = 0$)

- $M\ddot{w} = \underline{f} + \underline{f}_{acc}$
- $\underline{f} = N\underline{v} - K_s\underline{w}$
- $\underline{v} = -R_L\underline{i}_m = -R_L N\dot{w}$
- $M\ddot{w} + N^2 R_L \dot{w} + K_s w = \underline{f}_{acc}$
→ R_L acts as a damping
- $P_2 = -\frac{1}{2} R_L |i_m|^2$
- $|i_m| = N|\dot{w}| = \frac{\omega \cdot N \cdot |f_{acc}|}{\sqrt{(K_s - M\omega^2)^2 + (N^2 R_L \omega)^2}}$
- $P_2 = -\frac{1}{2} \frac{N^2 R_L \omega^2 |f_{acc}|^2}{(K_s - M\omega^2)^2 + (N^2 R_L \omega)^2}$
- $P_{2Max} = \frac{(MA\omega^2)^2}{2N^2 R_L}$

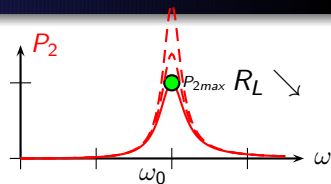

The vibrations should occur at generator's resonance frequency

$$\omega_0 = \sqrt{\frac{K_s}{M}}$$

For an ideal generator ($D_s = 0$)

- $M\ddot{w} = \underline{f} + \underline{f}_{acc}$
- $\underline{f} = N\underline{v} - K_s\underline{w}$
- $\underline{v} = -R_L\underline{i}_m = -R_L N\dot{w}$
- $M\ddot{w} + N^2 R_L \dot{w} + K_s w = \underline{f}_{acc}$
→ R_L acts as a damping
- $P_2 = -\frac{1}{2} R_L |i_m|^2$
- $|i_m| = N|\dot{w}| = \frac{\omega \cdot N \cdot |f_{acc}|}{\sqrt{(K_s - M\omega^2)^2 + (N^2 R_L \omega)^2}}$
- $P_2 = -\frac{1}{2} \frac{N^2 R_L \omega^2 |f_{acc}|^2}{(K_s - M\omega^2)^2 + (N^2 R_L \omega)^2}$
- $P_{2Max} = \frac{(MA\omega^2)^2}{2N^2 R_L}$

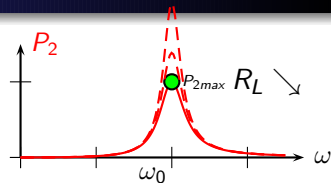

The vibrations should occur at generator's resonance frequency

$$\omega_0 = \sqrt{\frac{K_s}{M}}$$

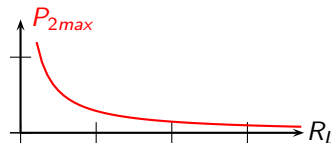

For an ideal generator ($D_s = 0$)

- $M\ddot{w} = \underline{f} + \underline{f}_{acc}$
- $\underline{f} = N\underline{v} - K_s\underline{w}$
- $\underline{v} = -R_L\underline{i}_m = -R_L N\dot{w}$
- $M\ddot{w} + N^2 R_L \dot{w} + K_s w = \underline{f}_{acc}$
 $\rightarrow R_L$ acts as a damping
- $P_2 = -\frac{1}{2} R_L |i_m|^2$
- $|i_m| = N|\dot{w}| = \frac{\omega \cdot N \cdot |f_{acc}|}{\sqrt{(K_s - M\omega^2)^2 + (N^2 R_L \omega)^2}}$
- $P_2 = -\frac{1}{2} \frac{N^2 R_L \omega^2 |f_{acc}|^2}{(K_s - M\omega^2)^2 + (N^2 R_L \omega)^2}$
- $P_{2Max} = \frac{(MA\omega^2)^2}{2N^2 R_L}$

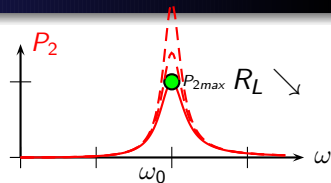

The vibrations should occur at generator's resonance frequency

$$\omega_0 = \sqrt{\frac{K_s}{M}}$$

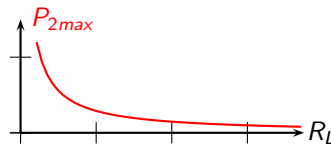

We can harvest as much power as we want

For an ideal generator ($D_s = 0$)

- $M\ddot{w} = \underline{f} + \underline{f}_{acc}$
- $\underline{f} = N\underline{v} - K_s\underline{w}$
- $\underline{v} = -R_L\underline{i}_m = -R_L N\dot{w}$
- $M\ddot{w} + N^2 R_L \dot{w} + K_s w = \underline{f}_{acc}$
 $\rightarrow R_L$ acts as a damping
- $P_2 = -\frac{1}{2} R_L |i_m|^2$
- $|i_m| = N|\dot{w}| = \frac{\omega \cdot N \cdot |f_{acc}|}{\sqrt{(K_s - M\omega^2)^2 + (N^2 R_L \omega)^2}}$
- $P_2 = -\frac{1}{2} \frac{N^2 R_L \omega^2 |f_{acc}|^2}{(K_s - M\omega^2)^2 + (N^2 R_L \omega)^2}$
- $P_{2Max} = \frac{(MA\omega^2)^2}{2N^2 R_L}$, $W_{max} = \frac{MA\omega}{N^2 R_L}$

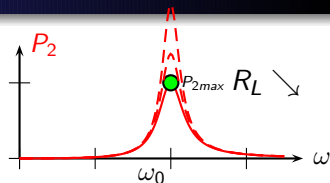

The vibrations should occur at generator's resonance frequency

$$\omega_0 = \sqrt{\frac{K_s}{M}}$$

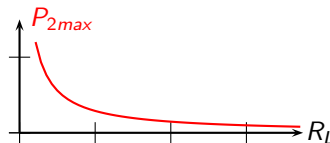

We can harvest as much power as we want

For an ideal generator ($D_s = 0$)

- $M\ddot{w} = \underline{f} + \underline{f}_{acc}$
- $\underline{f} = N\underline{v} - K_s\underline{w}$
- $\underline{v} = -R_L\underline{i}_m = -R_L N\dot{w}$
- $M\ddot{w} + N^2 R_L \dot{w} + K_s w = \underline{f}_{acc}$
 $\rightarrow R_L$ acts as a damping
- $P_2 = -\frac{1}{2} R_L |i_m|^2$
- $|i_m| = N|\dot{w}| = \frac{\omega \cdot N \cdot |f_{acc}|}{\sqrt{(K_s - M\omega^2)^2 + (N^2 R_L \omega)^2}}$
- $P_2 = -\frac{1}{2} \frac{N^2 R_L \omega^2 |f_{acc}|^2}{(K_s - M\omega^2)^2 + (N^2 R_L \omega)^2}$
- $P_{2Max} = \frac{(MA\omega^2)^2}{2N^2 R_L}$, $W_{max} = \frac{MA\omega}{N^2 R_L}$

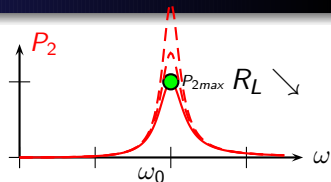

The vibrations should occur at generator's resonance frequency

$$\omega_0 = \sqrt{\frac{K_s}{M}}$$

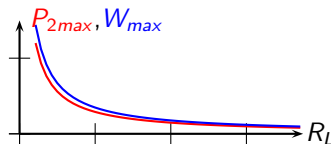

We can harvest as much power as we want

For an ideal generator ($D_s = 0$)

- $M\ddot{w} = \underline{f} + \underline{f}_{acc}$
- $\underline{f} = N\underline{v} - K_s\underline{w}$
- $\underline{v} = -R_L\underline{i}_m = -R_L N\dot{w}$
- $M\ddot{w} + N^2 R_L \dot{w} + K_s w = \underline{f}_{acc}$
 $\rightarrow R_L$ acts as a damping
- $P_2 = -\frac{1}{2} R_L |i_m|^2$
- $|i_m| = N|\dot{w}| = \frac{\omega \cdot N \cdot |f_{acc}|}{\sqrt{(K_s - M\omega^2)^2 + (N^2 R_L \omega)^2}}$
- $P_2 = -\frac{1}{2} \frac{N^2 R_L \omega^2 |f_{acc}|^2}{(K_s - M\omega^2)^2 + (N^2 R_L \omega)^2}$
- $P_{2Max} = \frac{(MA\omega^2)^2}{2N^2 R_L}$, $W_{max} = \frac{MA\omega}{N^2 R_L}$

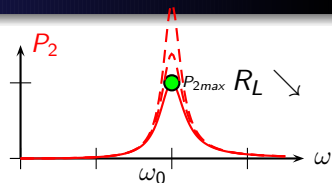

The vibrations should occur at generator's resonance frequency

$$\omega_0 = \sqrt{\frac{K_s}{M}}$$

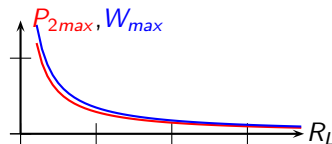

We can harvest as much power as we want, at the expense of large displacement of the bender's tip

For an ideal generator ($D_s = 0$)

- $M\ddot{w} = \underline{f} + \underline{f}_{acc}$
- $\underline{f} = N\underline{v} - K_s\underline{w}$
- $\underline{v} = -R_L\underline{i}_m = -R_L N\dot{w}$
- $M\ddot{w} + N^2 R_L \dot{w} + K_s w = \underline{f}_{acc}$
→ R_L acts as a damping
- $P_2 = -\frac{1}{2} R_L |i_m|^2$
- $|i_m| = N|\dot{w}| = \frac{\omega \cdot N \cdot |f_{acc}|}{\sqrt{(K_s - M\omega^2)^2 + (N^2 R_L \omega)^2}}$
- $P_2 = -\frac{1}{2} \frac{N^2 R_L \omega^2 |f_{acc}|^2}{(K_s - M\omega^2)^2 + (N^2 R_L \omega)^2}$
- $P_{2Max} = \frac{(MA\omega^2)^2}{2N^2 R_L}$, $W_{max} = \frac{MA\omega}{N^2 R_L}$

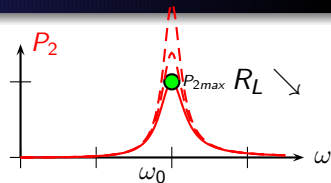

The vibrations should occur at generator's resonance frequency

$$\omega_0 = \sqrt{\frac{K_s}{M}}$$

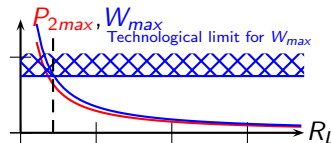

We can harvest as much power as we want, at the expense of large displacement of the bender's tip

For an ideal generator ($D_s = 0$)

- $M\ddot{w} = \underline{f} + \underline{f}_{acc}$
- $\underline{f} = N\underline{v} - K_s\underline{w}$
- $\underline{v} = -R_L\underline{i}_m = -R_L N\dot{w}$
- $M\ddot{w} + N^2 R_L \dot{w} + K_s w = \underline{f}_{acc}$
→ R_L acts as a damping
- $P_2 = -\frac{1}{2} R_L |i_m|^2$
- $|i_m| = N|\dot{w}| = \frac{\omega \cdot N \cdot |f_{acc}|}{\sqrt{(K_s - M\omega^2)^2 + (N^2 R_L \omega)^2}}$
- $P_2 = -\frac{1}{2} \frac{N^2 R_L \omega^2 |f_{acc}|^2}{(K_s - M\omega^2)^2 + (N^2 R_L \omega)^2}$
- $P_{2Max} = \frac{(MA\omega^2)^2}{2N^2 R_L}$, $W_{max} = \frac{MA\omega}{N^2 R_L}$,
 $v_{max} = \frac{MA\omega^2}{N}$

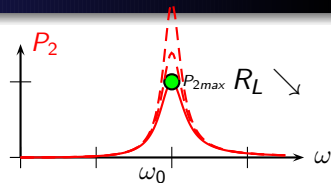

The vibrations should occur at generator's resonance frequency

$$\omega_0 = \sqrt{\frac{K_s}{M}}$$

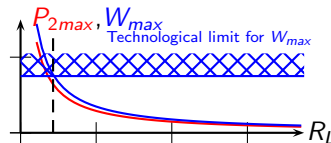

We can harvest as much power as we want, at the expense of large displacement of the bender's tip

For an ideal generator ($D_s = 0$)

- $M\ddot{w} = \underline{f} + \underline{f}_{acc}$
- $\underline{f} = N\underline{v} - K_s\underline{w}$
- $\underline{v} = -R_L\underline{i}_m = -R_L N\dot{w}$
- $M\ddot{w} + N^2 R_L \dot{w} + K_s w = \underline{f}_{acc}$
→ R_L acts as a damping
- $P_2 = -\frac{1}{2} R_L |i_m|^2$
- $|i_m| = N|\dot{w}| = \frac{\omega \cdot N \cdot |f_{acc}|}{\sqrt{(K_s - M\omega^2)^2 + (N^2 R_L \omega)^2}}$
- $P_2 = -\frac{1}{2} \frac{N^2 R_L \omega^2 |f_{acc}|^2}{(K_s - M\omega^2)^2 + (N^2 R_L \omega)^2}$
- $P_{2Max} = \frac{(MA\omega^2)^2}{2N^2 R_L}$, $W_{max} = \frac{MA\omega}{N^2 R_L}$,
 $v_{max} = \frac{MA\omega^2}{N}$
- $P_{1Max} = \frac{1}{2} f_{acc} \omega W_{Max} = \frac{(MA\omega^2)^2}{N^2 R_L} = P_{2Max}$

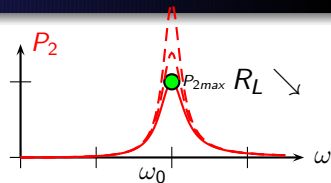

The vibrations should occur at generator's resonance frequency

$$\omega_0 = \sqrt{\frac{K_s}{M}}$$

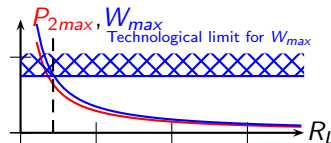

We can harvest as much power as we want, at the expense of large displacement of the bender's tip

For an ideal generator ($D_s = 0$)

- $M\ddot{w} = \underline{f} + \underline{f}_{acc}$
- $\underline{f} = N\underline{v} - K_s\underline{w}$
- $\underline{v} = -R_L\underline{i}_m = -R_L N\dot{w}$
- $M\ddot{w} + N^2 R_L \dot{w} + K_s w = \underline{f}_{acc}$
→ R_L acts as a damping
- $P_2 = -\frac{1}{2} R_L |i_m|^2$
- $|i_m| = N|\dot{w}| = \frac{\omega \cdot N \cdot |f_{acc}|}{\sqrt{(K_s - M\omega^2)^2 + (N^2 R_L \omega)^2}}$
- $P_2 = -\frac{1}{2} \frac{N^2 R_L \omega^2 |f_{acc}|^2}{(K_s - M\omega^2)^2 + (N^2 R_L \omega)^2}$
- $P_{2Max} = \frac{(MA\omega^2)^2}{2N^2 R_L}$, $W_{max} = \frac{MA\omega}{N^2 R_L}$,
 $v_{max} = \frac{MA\omega^2}{N}$
- $P_{1Max} = \frac{1}{2} f_{acc} \omega W_{Max} = \frac{(MA\omega^2)^2}{N^2 R_L} = P_{2Max}$

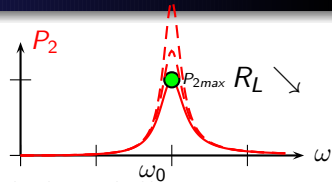

The vibrations should occur at generator's resonance frequency

$$\omega_0 = \sqrt{\frac{K_s}{M}}$$

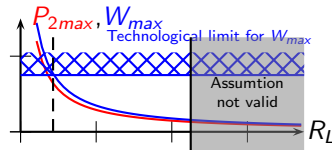

We can harvest as much power as we want, at the expense of large displacement of the bender's tip

For a real generator ($D_s \neq 0$)

- $\underline{f} = N\underline{v} - K_s\underline{w} - D_s\underline{\dot{w}}$

For a real generator ($D_s \neq 0$)

- $\underline{f} = N\underline{v} - K_s\underline{w} - D_s\dot{\underline{w}}$
- $\underline{w} = \frac{\underline{f}_{acc}}{(K_s - M\omega^2) + j\omega(D_s + N^2R_L)}$

For a real generator ($D_s \neq 0$)

- $\underline{f} = N\underline{v} - K_s\underline{w} - D_s\dot{\underline{w}}$
- $\underline{w} = \frac{\underline{f}_{acc}}{(K_s - M\omega^2) + j\omega(D_s + N^2R_L)}$
- $P_2 = -\frac{1}{2}R_L|i_m|^2$

For a real generator ($D_s \neq 0$)

- $\underline{f} = N\underline{v} - K_s\underline{w} - D_s\dot{\underline{w}}$
- $\underline{w} = \frac{\underline{f}_{acc}}{(K_s - M\omega^2) + j\omega(D_s + N^2R_L)}$
- $P_2 = -\frac{1}{2}R_L|i_m|^2$
- $P_2 = -\frac{1}{2} \frac{R_L N^2 \omega^2 |\underline{f}_{acc}|^2}{(K_s - M\omega^2)^2 + \omega^2 (D_s + N^2 R_L)^2}$

For a real generator ($D_s \neq 0$)

- $\underline{f} = N\underline{v} - K_s\underline{w} - D_s\dot{\underline{w}}$
- $\underline{w} = \frac{\underline{f}_{acc}}{(K_s - M\omega^2) + j\omega(D_s + N^2R_L)}$
- $P_2 = -\frac{1}{2}R_L|i_m|^2$
- $P_2 = -\frac{1}{2} \frac{R_L N^2 \omega^2 |\underline{f}_{acc}|^2}{(K_s - M\omega^2)^2 + \omega^2 (D_s + N^2 R_L)^2}$
- $P_1 = -\frac{1}{2} \Re(\underline{f}_{acc} \cdot \dot{\underline{w}}^*)$

For a real generator ($D_s \neq 0$)

- $\underline{f} = N\underline{v} - K_s\underline{w} - D_s\dot{\underline{w}}$
- $\underline{w} = \frac{\underline{f}_{acc}}{(K_s - M\omega^2) + j\omega(D_s + N^2R_L)}$
- $P_2 = -\frac{1}{2}R_L|i_m|^2$
- $P_2 = -\frac{1}{2} \frac{R_L N^2 \omega^2 |\underline{f}_{acc}|^2}{(K_s - M\omega^2)^2 + \omega^2 (D_s + N^2 R_L)^2}$
- $P_1 = -\frac{1}{2} \Re(\underline{f}_{acc} \cdot \dot{\underline{w}}^*)$
- $P_1 = -\frac{1}{2} \frac{(D_s + R_L N^2) \omega^2 |\underline{f}_{acc}|^2}{(K_s - M\omega^2)^2 + \omega^2 (D_s + N^2 R_L)^2}$

For a real generator ($D_s \neq 0$)

- $\underline{f} = N\underline{v} - K_s\underline{w} - D_s\dot{\underline{w}}$
- $\underline{w} = \frac{\underline{f}_{acc}}{(K_s - M\omega^2) + j\omega(D_s + N^2R_L)}$
- $P_2 = -\frac{1}{2}R_L|i_m|^2$
- $P_2 = -\frac{1}{2} \frac{R_L N^2 \omega^2 |\underline{f}_{acc}|^2}{(K_s - M\omega^2)^2 + \omega^2 (D_s + N^2 R_L)^2}$
- $P_1 = -\frac{1}{2} \Re(\underline{f}_{acc} \cdot \dot{\underline{w}}^*)$
- $P_1 = -\frac{1}{2} \frac{(D_s + R_L N^2) \omega^2 |\underline{f}_{acc}|^2}{(K_s - M\omega^2)^2 + \omega^2 (D_s + N^2 R_L)^2}$

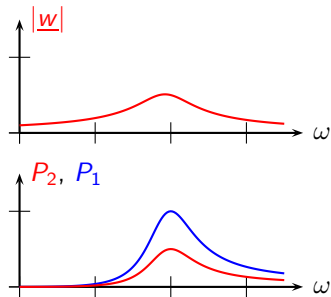

For a real generator ($D_s \neq 0$)

- $\underline{f} = N\underline{v} - K_s\underline{w} - D_s\dot{\underline{w}}$
- $\underline{w} = \frac{\underline{f}_{acc}}{(K_s - M\omega^2) + j\omega(D_s + N^2R_L)}$
- $P_2 = -\frac{1}{2}R_L|i_m|^2$
- $P_2 = -\frac{1}{2} \frac{R_L N^2 \omega^2 |\underline{f}_{acc}|^2}{(K_s - M\omega^2)^2 + \omega^2 (D_s + N^2 R_L)^2}$
- $P_1 = -\frac{1}{2} \Re(\underline{f}_{acc} \cdot \dot{\underline{w}}^*)$
- $P_1 = -\frac{1}{2} \frac{(D_s + R_L N^2) \omega^2 |\underline{f}_{acc}|^2}{(K_s - M\omega^2)^2 + \omega^2 (D_s + N^2 R_L)^2}$

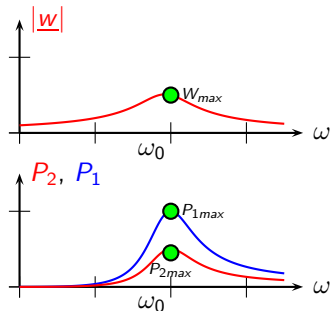

For a real generator ($D_s \neq 0$)

- $\underline{f} = N\underline{v} - K_s\underline{w} - D_s\dot{\underline{w}}$
- $\underline{w} = \frac{\underline{f}_{acc}}{(K_s - M\omega^2) + j\omega(D_s + N^2R_L)}$
- $P_2 = -\frac{1}{2}R_L|i_m|^2$
- $P_2 = -\frac{1}{2} \frac{R_L N^2 \omega^2 |\underline{f}_{acc}|^2}{(K_s - M\omega^2)^2 + \omega^2 (D_s + N^2 R_L)^2}$
- $P_1 = -\frac{1}{2} \Re(\underline{f}_{acc} \cdot \dot{\underline{w}}^*)$
- $P_1 = -\frac{1}{2} \frac{(D_s + R_L N^2) \omega^2 |\underline{f}_{acc}|^2}{(K_s - M\omega^2)^2 + \omega^2 (D_s + N^2 R_L)^2}$

ω_0 should still be the vibration's pulsation.

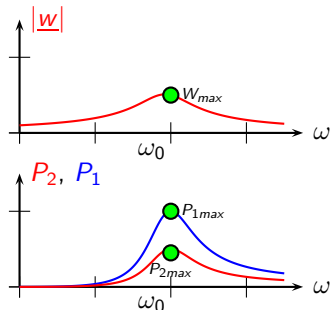

For a real generator ($D_s \neq 0$)

- $\underline{f} = N\underline{v} - K_s\underline{w} - D_s\dot{\underline{w}}$
- $\underline{w} = \frac{\underline{f}_{acc}}{(K_s - M\omega^2) + j\omega(D_s + N^2R_L)}$
- $P_2 = -\frac{1}{2}R_L|i_m|^2$
- $P_2 = -\frac{1}{2} \frac{R_L N^2 \omega^2 |\underline{f}_{acc}|^2}{(K_s - M\omega^2)^2 + \omega^2 (D_s + N^2 R_L)^2}$
- $P_1 = -\frac{1}{2} \Re(\underline{f}_{acc} \cdot \dot{\underline{w}}^*)$
- $P_1 = -\frac{1}{2} \frac{(D_s + R_L N^2) \omega^2 |\underline{f}_{acc}|^2}{(K_s - M\omega^2)^2 + \omega^2 (D_s + N^2 R_L)^2}$

ω_0 should still be the vibration's pulsation.

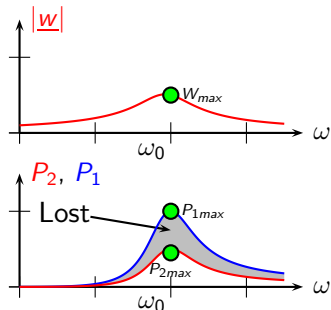

For a real generator ($D_s \neq 0$)

- $\underline{f} = N\underline{v} - K_s\underline{w} - D_s\dot{\underline{w}}$
- $\underline{w} = \frac{\underline{f}_{acc}}{(K_s - M\omega^2) + j\omega(D_s + N^2R_L)}$
- $P_2 = -\frac{1}{2}R_L|i_m|^2$
- $P_2 = -\frac{1}{2} \frac{R_L N^2 \omega^2 |\underline{f}_{acc}|^2}{(K_s - M\omega^2)^2 + \omega^2 (D_s + N^2 R_L)^2}$
- $P_1 = -\frac{1}{2} \Re(\underline{f}_{acc} \cdot \dot{\underline{w}}^*)$
- $P_1 = -\frac{1}{2} \frac{(D_s + R_L N^2) \omega^2 |\underline{f}_{acc}|^2}{(K_s - M\omega^2)^2 + \omega^2 (D_s + N^2 R_L)^2}$

ω_0 should still be the vibration's pulsation.

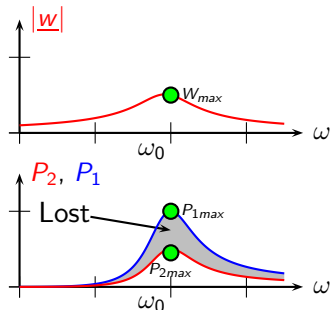

Generator's Power Losses

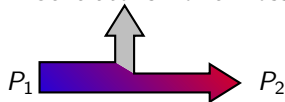

For a real generator ($D_s \neq 0$)

- $\underline{f} = N\underline{v} - K_s\underline{w} - D_s\dot{\underline{w}}$
- $\underline{w} = \frac{\underline{f}_{acc}}{(K_s - M\omega^2) + j\omega(D_s + N^2R_L)}$
- $P_2 = -\frac{1}{2}R_L|i_m|^2$
- $P_2 = -\frac{1}{2} \frac{R_L N^2 \omega^2 |f_{acc}|^2}{(K_s - M\omega^2)^2 + \omega^2 (D_s + N^2 R_L)^2}$
- $P_1 = -\frac{1}{2} \Re(\underline{f}_{acc} \cdot \dot{\underline{w}}^*)$
- $P_1 = -\frac{1}{2} \frac{(D_s + R_L N^2) \omega^2 |f_{acc}|^2}{(K_s - M\omega^2)^2 + \omega^2 (D_s + N^2 R_L)^2}$

ω_0 should still be the vibration's pulsation.

- $W_{max} = \frac{|f_{acc}|}{(D_s + N^2 R_L) \omega_0}$, $P_{1max} = \frac{1}{2} \frac{|f_{acc}|^2}{D_s + N^2 R_L}$,
 $P_{2max} = \frac{1}{2} \frac{N^2 R_L |f_{acc}|^2}{(D_s + N^2 R_L)^2}$

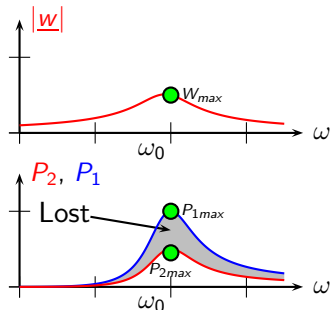

Generator's Power Losses



For a real generator ($D_s \neq 0$)

- $W_{max} = \frac{|f_{acc}|}{(D_s + N^2 R_L) \omega_0}, P_{1max} = \frac{1}{2} \frac{|f_{acc}|^2}{D_s + N^2 R_L}$
- $P_{2max} = \frac{1}{2} \frac{N^2 R_L |f_{acc}|^2}{(D_s + N^2 R_L)^2}$

For a real generator ($D_s \neq 0$)

- $W_{max} = \frac{|f_{acc}|}{(D_s + N^2 R_L) \omega_0}$, $P_{1max} = \frac{1}{2} \frac{|f_{acc}|^2}{D_s + N^2 R_L}$
- $P_{2max} = \frac{1}{2} \frac{N^2 R_L |f_{acc}|^2}{(D_s + N^2 R_L)^2}$

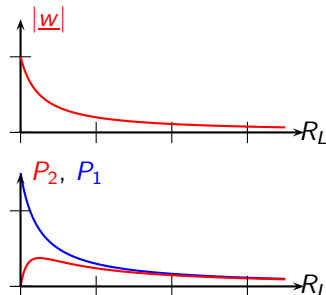

For a real generator ($D_s \neq 0$)

- $W_{max} = \frac{|f_{acc}|}{(D_s + N^2 R_L) \omega_0}$, $P_{1max} = \frac{1}{2} \frac{|f_{acc}|^2}{D_s + N^2 R_L}$
- $P_{2max} = \frac{1}{2} \frac{N^2 R_L |f_{acc}|^2}{(D_s + N^2 R_L)^2}$

When $R_L \searrow$, $P_1 \nearrow$, which is good, but the losses increase as well: it exists an optimal value of R_L which optimizes P_2 for a given vibration amplitude.

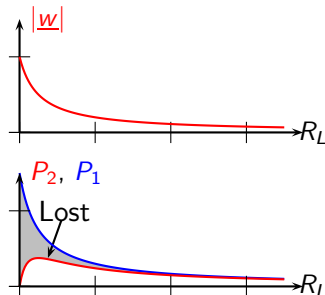

For a real generator ($D_s \neq 0$)

- $W_{max} = \frac{|f_{acc}|}{(D_s + N^2 R_L) \omega_0}$, $P_{1max} = \frac{1}{2} \frac{|f_{acc}|^2}{D_s + N^2 R_L}$
- $P_{2max} = \frac{1}{2} \frac{N^2 R_L |f_{acc}|^2}{(D_s + N^2 R_L)^2}$

When $R_L \searrow$, $P_1 \nearrow$, which is good, but the losses increase as well: it exists an optimal value of R_L which optimizes P_2 for a given vibration amplitude. It can be shown:

- $R_{Lopt} = \frac{D_s}{N^2}$,
- $P_{2opt} = \frac{|f_{acc}|^2}{8D_s}$
- $P_{1opt} = \frac{|f_{acc}|^2}{4D_s} = 2 \cdot P_{2opt}$

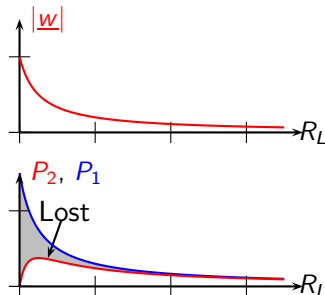

For a real generator ($D_s \neq 0$)

- $W_{max} = \frac{|f_{acc}|}{(D_s + N^2 R_L) \omega_0}$, $P_{1max} = \frac{1}{2} \frac{|f_{acc}|^2}{D_s + N^2 R_L}$
- $P_{2max} = \frac{1}{2} \frac{N^2 R_L |f_{acc}|^2}{(D_s + N^2 R_L)^2}$

When $R_L \searrow$, $P_1 \nearrow$, which is good, but the losses increase as well: it exists an optimal value of R_L which optimizes P_2 for a given vibration amplitude. It can be shown:

- $R_{Lopt} = \frac{D_s}{N^2}$,
- $P_{2opt} = \frac{|f_{acc}|^2}{8D_s}$
- $P_{1opt} = \frac{|f_{acc}|^2}{4D_s} = 2 \cdot P_{2opt}$

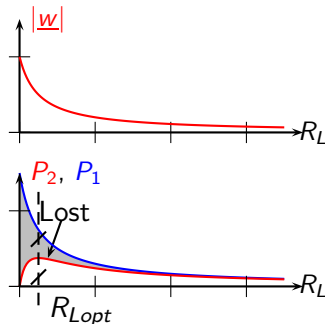

For a real generator ($D_s \neq 0$)

- $W_{max} = \frac{|f_{acc}|}{(D_s + N^2 R_L) \omega_0}$, $P_{1max} = \frac{1}{2} \frac{|f_{acc}|^2}{D_s + N^2 R_L}$
- $P_{2max} = \frac{1}{2} \frac{N^2 R_L |f_{acc}|^2}{(D_s + N^2 R_L)^2}$

When $R_L \searrow$, $P_1 \nearrow$, which is good, but the losses increase as well: it exists an optimal value of R_L which optimizes P_2 for a given vibration amplitude. It can be shown:

- $R_{Lopt} = \frac{D_s}{N^2}$,
- $P_{2opt} = \frac{|f_{acc}|^2}{8D_s}$
- $P_{1opt} = \frac{|f_{acc}|^2}{4D_s} = 2 \cdot P_{2opt}$
- $|\underline{v}_{max}| = NR_L \omega_0 |\underline{w}| = \frac{NR_L |f_{acc}|}{(D_s + N^2 R_L)}$

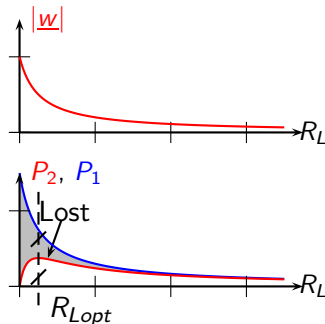

For a real generator ($D_s \neq 0$)

- $W_{max} = \frac{|f_{acc}|}{(D_s + N^2 R_L) \omega_0}$, $P_{1max} = \frac{1}{2} \frac{|f_{acc}|^2}{D_s + N^2 R_L}$
- $P_{2max} = \frac{1}{2} \frac{N^2 R_L |f_{acc}|^2}{(D_s + N^2 R_L)^2}$

When $R_L \searrow$, $P_1 \nearrow$, which is good, but the losses increase as well: it exists an optimal value of R_L which optimizes P_2 for a given vibration amplitude. It can be shown:

- $R_{Lopt} = \frac{D_s}{N^2}$,
- $P_{2opt} = \frac{|f_{acc}|^2}{8D_s}$
- $P_{1opt} = \frac{|f_{acc}|^2}{4D_s} = 2 \cdot P_{2opt}$
- $|v_{max}| = NR_L \omega_0 |w| = \frac{NR_L |f_{acc}|}{(D_s + N^2 R_L)}$

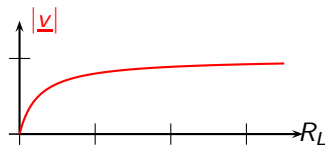
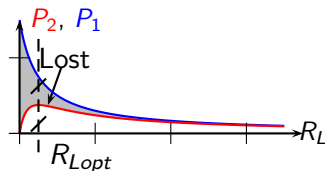
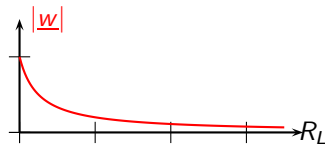

For a real generator ($D_s \neq 0$)

- $W_{max} = \frac{|f_{acc}|}{(D_s + N^2 R_L) \omega_0}$, $P_{1max} = \frac{1}{2} \frac{|f_{acc}|^2}{D_s + N^2 R_L}$
- $P_{2max} = \frac{1}{2} \frac{N^2 R_L |f_{acc}|^2}{(D_s + N^2 R_L)^2}$

When $R_L \searrow$, $P_1 \nearrow$, which is good, but the losses increase as well: it exists an optimal value of R_L which optimizes P_2 for a given vibration amplitude. It can be shown:

- $R_{Lopt} = \frac{D_s}{N^2}$,
- $P_{2opt} = \frac{|f_{acc}|^2}{8D_s}$
- $P_{1opt} = \frac{|f_{acc}|^2}{4D_s} = 2 \cdot P_{2opt}$
- $|v_{max}| = NR_L \omega_0 |w| = \frac{NR_L |f_{acc}|}{(D_s + N^2 R_L)}$

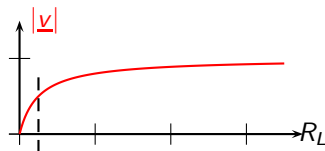
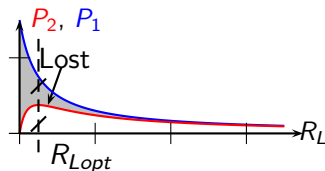
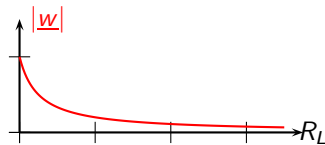

For a real generator ($D_s \neq 0$)

- $W_{max} = \frac{|f_{acc}|}{(D_s + N^2 R_L) \omega_0}$, $P_{1max} = \frac{1}{2} \frac{|f_{acc}|^2}{D_s + N^2 R_L}$
- $P_{2max} = \frac{1}{2} \frac{N^2 R_L |f_{acc}|^2}{(D_s + N^2 R_L)^2}$

When $R_L \searrow$, $P_1 \nearrow$, which is good, but the losses increase as well: it exists an optimal value of R_L which optimizes P_2 for a given vibration amplitude. It can be shown:

- $R_{Lopt} = \frac{D_s}{N^2}$,
- $P_{2opt} = \frac{|f_{acc}|^2}{8D_s}$
- $P_{1opt} = \frac{|f_{acc}|^2}{4D_s} = 2 \cdot P_{2opt}$
- $|v_{max}| = NR_L \omega_0 |w| = \frac{NR_L |f_{acc}|}{(D_s + N^2 R_L)}$
- voltage is not so high.

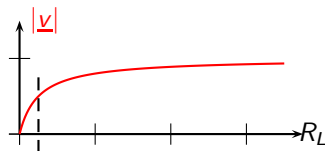
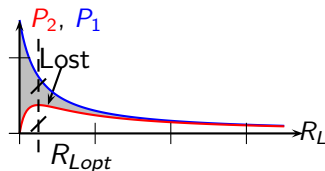
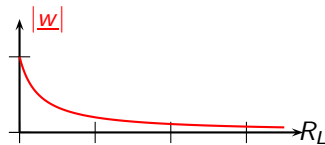

For a real generator ($D_s \neq 0$)

- $W_{max} = \frac{|f_{acc}|}{(D_s + N^2 R_L) \omega_0}$, $P_{1max} = \frac{1}{2} \frac{|f_{acc}|^2}{D_s + N^2 R_L}$
- $P_{2max} = \frac{1}{2} \frac{N^2 R_L |f_{acc}|^2}{(D_s + N^2 R_L)^2}$

When $R_L \searrow$, $P_1 \nearrow$, which is good, but the losses increase as well: it exists an optimal value of R_L which optimizes P_2 for a given vibration amplitude. It can be shown:

- $R_{Lopt} = \frac{D_s}{N^2}$,
- $P_{2opt} = \frac{|f_{acc}|^2}{8D_s}$
- $P_{1opt} = \frac{|f_{acc}|^2}{4D_s} = 2 \cdot P_{2opt}$
- $|v_{max}| = N R_L \omega_0 |w| = \frac{N R_L |f_{acc}|}{(D_s + N^2 R_L)}$
- voltage is not so high.

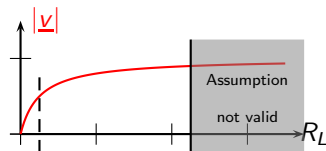
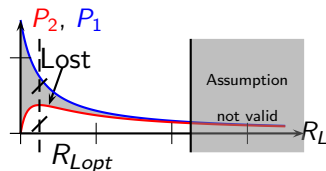
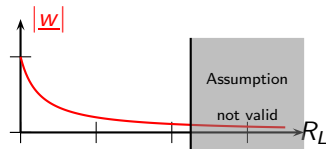

Example

Device's properties

$$N = 0.012 \text{ N/V}, K_s = 6300 \text{ N/m}, C_b = 300 \text{ nF}, D_s = 0.17 \text{ Ns/m}, \\ M = 1 \text{ g}$$

Calculate for $A = 0.1 \text{ mm}$

- the best working frequency,
- the harvested P_2 power in the best case,
- the power of the source P_1 in such best case,
- the optimal resistor R_L ,
- the deflection amplitude of the bender,
- the voltage for this working point.

Validation

Is $v = -R_L i_m$ a valid assumption?

Answers

- The best working frequency is given by

$$f_0 = \frac{1}{2\pi} \sqrt{\frac{K_s}{M}} = \frac{1}{2\pi} \sqrt{\frac{6300}{1.10^{-3}}} = \underline{400Hz}$$

Answers

- The best working frequency is given by

$$f_0 = \frac{1}{2\pi} \sqrt{\frac{K_s}{M}} = \frac{1}{2\pi} \sqrt{\frac{6300}{1 \cdot 10^{-3}}} = \underline{400\text{Hz}}$$

- For the best case, P_2 is given by

$$P_2 = \frac{|f_{acc}|^2}{8D_s} = \frac{(1 \cdot 10^{-3} \cdot 1 \cdot 10^{-4} \cdot (2\pi \cdot 400)^2)^2}{8 \cdot 0,17} = \underline{464\text{mW}}$$

Answers

- The best working frequency is given by

$$f_0 = \frac{1}{2\pi} \sqrt{\frac{K_s}{M}} = \frac{1}{2\pi} \sqrt{\frac{6300}{1 \cdot 10^{-3}}} = \underline{400\text{Hz}}$$

- For the best case, P_2 is given by

$$P_2 = \frac{|f_{acc}|^2}{8D_s} = \frac{(1 \cdot 10^{-3} \cdot 1 \cdot 10^{-4} \cdot (2\pi \cdot 400)^2)^2}{8 \cdot 0,17} = \underline{464\text{mW}}$$

- For the best case $P_1 = 2 \cdot P_2 = \underline{928\text{mW}}$

Answers

- The best working frequency is given by

$$f_0 = \frac{1}{2\pi} \sqrt{\frac{K_s}{M}} = \frac{1}{2\pi} \sqrt{\frac{6300}{1.10^{-3}}} = \underline{400\text{Hz}}$$

- For the best case, P_2 is given by

$$P_2 = \frac{|f_{\text{acc}}|^2}{8D_s} = \frac{(1.10^{-3} \cdot 1.10^{-4} \cdot (2\pi \cdot 400)^2)^2}{8.0,17} = \underline{464\text{mW}}$$

- For the best case $P_1 = 2 \cdot P_2 = \underline{928\text{mW}}$

- The optimal resistor R_{Lopt} is given by

$$R_{Lopt} = \frac{D_s}{N^2} = \frac{0,17}{0,012^2} = \underline{1180\Omega}$$

Answers

- The best working frequency is given by

$$f_0 = \frac{1}{2\pi} \sqrt{\frac{K_s}{M}} = \frac{1}{2\pi} \sqrt{\frac{6300}{1.10^{-3}}} = \underline{400\text{Hz}}$$

- For the best case, P_2 is given by

$$P_2 = \frac{|f_{acc}|^2}{8D_s} = \frac{(1.10^{-3} \cdot 1.10^{-4} \cdot (2\pi \cdot 400)^2)^2}{8 \cdot 0,17} = \underline{464\text{mW}}$$

- For the best case $P_1 = 2 \cdot P_2 = \underline{928\text{mW}}$

- The optimal resistor R_{Lopt} is given by

$$R_{Lopt} = \frac{D_s}{N^2} = \frac{0,17}{0,012^2} = \underline{1180\Omega}$$

- The deflection W_{max} is given by

$$W_{max} = \frac{|f_{acc}|}{(D_s + N^2 R_L)\omega_0} = \frac{(1.10^{-3} \cdot 1.10^{-4} \cdot (2\pi \cdot 400)^2)}{2 \cdot 0,17 \cdot 2\pi \cdot 400} = \underline{738\mu\text{m!}}$$

Answers

- The best working frequency is given by

$$f_0 = \frac{1}{2\pi} \sqrt{\frac{K_s}{M}} = \frac{1}{2\pi} \sqrt{\frac{6300}{1.10^{-3}}} = \underline{400\text{Hz}}$$

- For the best case, P_2 is given by

$$P_2 = \frac{|f_{acc}|^2}{8D_s} = \frac{(1.10^{-3} \cdot 1.10^{-4} \cdot (2\pi \cdot 400)^2)^2}{8 \cdot 0,17} = \underline{464\text{mW}}$$

- For the best case $P_1 = 2 \cdot P_2 = \underline{928\text{mW}}$

- The optimal resistor R_{Lopt} is given by

$$R_{Lopt} = \frac{D_s}{N^2} = \frac{0,17}{0,012^2} = \underline{1180\Omega}$$

- The deflection W_{max} is given by

$$W_{max} = \frac{|f_{acc}|}{(D_s + N^2 R_L) \omega_0} = \frac{(1.10^{-3} \cdot 1.10^{-4} \cdot (2\pi \cdot 400)^2)}{2 \cdot 0,17 \cdot 2\pi \cdot 400} = \underline{738\mu\text{m}}$$

- The voltage is then given by

$$v_{max} = N R_L \omega_0 |w| = 0,012 \cdot 1180 \cdot 2\pi \cdot 400 \cdot 738 \cdot 10^{-6} = \underline{26\text{V}}$$

Answers

- The best working frequency is given by

$$f_0 = \frac{1}{2\pi} \sqrt{\frac{K_s}{M}} = \frac{1}{2\pi} \sqrt{\frac{6300}{1.10^{-3}}} = \underline{400\text{Hz}}$$

- For the best case, P_2 is given by

$$P_2 = \frac{|f_{acc}|^2}{8D_s} = \frac{(1.10^{-3} \cdot 1.10^{-4} \cdot (2\pi \cdot 400)^2)^2}{8 \cdot 0,17} = \underline{464\text{mW}}$$

- For the best case $P_1 = 2 \cdot P_2 = \underline{928\text{mW}}$

- The optimal resistor R_{Lopt} is given by

$$R_{Lopt} = \frac{D_s}{N^2} = \frac{0,17}{0,012^2} = \underline{1180\Omega}$$

- The deflection W_{max} is given by

$$W_{max} = \frac{|f_{acc}|}{(D_s + N^2 R_L) \omega_0} = \frac{(1.10^{-3} \cdot 1.10^{-4} \cdot (2\pi \cdot 400)^2)}{2 \cdot 0,17 \cdot 2\pi \cdot 400} = \underline{738\mu\text{m}}$$

- The voltage is then given by

$$v_{max} = N R_L \omega_0 |w| = 0,012 \cdot 1180 \cdot 2\pi \cdot 400 \cdot 738 \cdot 10^{-6} = \underline{26\text{V}}$$

- $Z_{Cb} = \frac{1}{C_b \omega} = \frac{1}{2\pi \cdot 400 \cdot 300 \cdot 10^{-9}} = \underline{1990\Omega} \approx R_L, \rightarrow$ **Calculations are NOT valid!**

For a real Generator, $D_s \neq 0$ and $v \neq -R_L i_m$

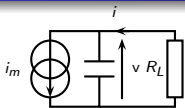

For a real Generator, $D_s \neq 0$ and $v \neq -R_L i_m$

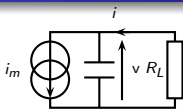

We can show:

$$\underline{v} = -\frac{R_L}{1+j\omega R_L C_b} \underline{i}_m = -j\omega N R_L \frac{1-j\omega R_L C_b}{1+(R_L C_b \omega)^2} \underline{w}_m$$

and we write: $\underline{v} = -j\omega N r_{Leq} \underline{w} - N k_{eq} \underline{w}$

For a real Generator, $D_s \neq 0$ and $v \neq -R_L i_m$

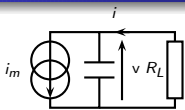

We can show:

$$\underline{v} = -\frac{R_L}{1+j\omega R_L C_b} \underline{i}_m = -j\omega N R_L \frac{1-j\omega R_L C_b}{1+(R_L C_b \omega)^2} \underline{\omega}_m$$

and we write: $\underline{v} = -j\omega N r_{Leq} \underline{\omega} - N k_{eq} \underline{\omega}$

2 Cases to consider, since ω should be ω_0 :

For a real Generator, $D_s \neq 0$ and $v \neq -R_L i_m$

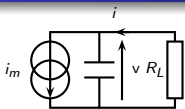

We can show:

$$\underline{v} = -\frac{R_L}{1+j\omega R_L C_b} \underline{i}_m = -j\omega N R_L \frac{1-j\omega R_L C_b}{1+(R_L C_b \omega)^2} \underline{w}_m$$

and we write: $\underline{v} = -j\omega N r_{Leq} \underline{w} - N k_{eq} \underline{w}$

2 Cases to consider, since ω should be ω_0 :

$$\omega_0 \ll \frac{1}{R_L C_b}$$

For a real Generator, $D_s \neq 0$ and $v \neq -R_L i_m$

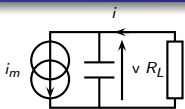

We can show:

$$\underline{v} = -\frac{R_L}{1+j\omega R_L C_b} \underline{i}_m = -j\omega N R_L \frac{1-j\omega R_L C_b}{1+(R_L C_b \omega)^2} \underline{w}_m$$

and we write: $\underline{v} = -j\omega N r_{Leq} \underline{w} - N k_{eq} \underline{w}$

2 Cases to consider, since ω should be ω_0 :

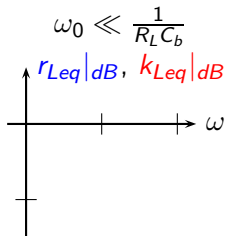

For a real Generator, $D_s \neq 0$ and $v \neq -R_L i_m$

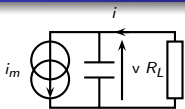

We can show:

$$\underline{v} = -\frac{R_L}{1+j\omega R_L C_b} \underline{i}_m = -j\omega N R_L \frac{1-j\omega R_L C_b}{1+(R_L C_b \omega)^2} \underline{w}_m$$

and we write: $\underline{v} = -j\omega N r_{Leq} \underline{w} - N k_{eq} \underline{w}$

2 Cases to consider, since ω should be ω_0 :

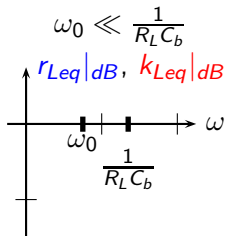

For a real Generator, $D_s \neq 0$ and $v \neq -R_L i_m$

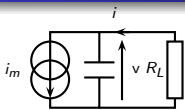

We can show:

$$\underline{v} = -\frac{R_L}{1+j\omega R_L C_b} \underline{i}_m = -j\omega N R_L \frac{1-j\omega R_L C_b}{1+(R_L C_b \omega)^2} \underline{w}_m$$

and we write: $\underline{v} = -j\omega N r_{Leq} \underline{w} - N k_{eq} \underline{w}$

2 Cases to consider, since ω should be ω_0 :

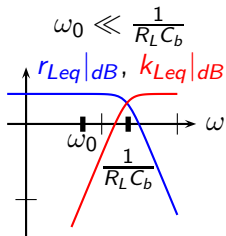

For a real Generator, $D_s \neq 0$ and $v \neq -R_L i_m$

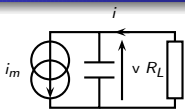

We can show:

$$\underline{v} = -\frac{R_L}{1+j\omega R_L C_b} \underline{i}_m = -j\omega N R_L \frac{1-j\omega R_L C_b}{1+(R_L C_b \omega)^2} \underline{w}_m$$

and we write: $\underline{v} = -j\omega N r_{Leq} \underline{w} - N k_{eq} \underline{w}$

2 Cases to consider, since ω should be ω_0 :

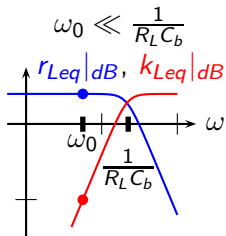

For a real Generator, $D_s \neq 0$ and $v \neq -R_L i_m$

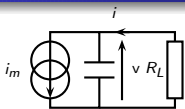

We can show:

$$\underline{v} = -\frac{R_L}{1+j\omega R_L C_b} \underline{i}_m = -j\omega N R_L \frac{1-j\omega R_L C_b}{1+(R_L C_b \omega)^2} \underline{w}_m$$

and we write: $\underline{v} = -j\omega N r_{Leq} \underline{w} - N k_{eq} \underline{w}$

2 Cases to consider, since ω should be ω_0 :

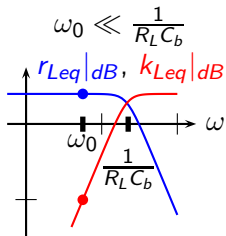

$r_{Leq} \simeq R_L$ and $k_{Leq} \simeq 0$, no problem,
 just use the assumption

For a real Generator, $D_s \neq 0$ and $v \neq -R_L i_m$

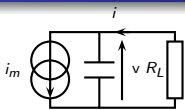

We can show:

$$\underline{v} = -\frac{R_L}{1+j\omega R_L C_b} \underline{i}_m = -j\omega N R_L \frac{1-j\omega R_L C_b}{1+(R_L C_b \omega)^2} \underline{w}_m$$

and we write: $\underline{v} = -j\omega N r_{Leq} \underline{w} - N k_{eq} \underline{w}$

2 Cases to consider, since ω should be ω_0 :

$$\omega_0 \ll \frac{1}{R_L C_b}$$

$$\omega_0 \gg \frac{1}{R_L C_b}$$

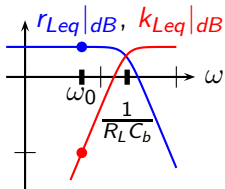

$r_{Leq} \simeq R_L$ and $k_{Leq} \simeq 0$, no problem,
just use the assumption

For a real Generator, $D_s \neq 0$ and $v \neq -R_L i_m$

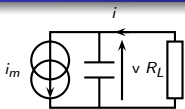

We can show:

$$\underline{v} = -\frac{R_L}{1+j\omega R_L C_b} \underline{i}_m = -j\omega N R_L \frac{1-j\omega R_L C_b}{1+(R_L C_b \omega)^2} \underline{w}_m$$

and we write: $\underline{v} = -j\omega N r_{Leq} \underline{w} - N k_{eq} \underline{w}$

2 Cases to consider, since ω should be ω_0 :

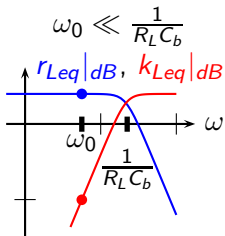

$r_{Leq} \simeq R_L$ and $k_{Leq} \simeq 0$, no problem,
 just use the assumption

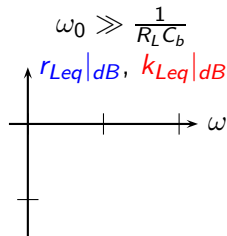

For a real Generator, $D_s \neq 0$ and $v \neq -R_L i_m$

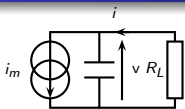

We can show:

$$\underline{v} = -\frac{R_L}{1+j\omega R_L C_b} \underline{i}_m = -j\omega N R_L \frac{1-j\omega R_L C_b}{1+(R_L C_b \omega)^2} \underline{w}_m$$

and we write: $\underline{v} = -j\omega N r_{Leq} \underline{w} - N k_{eq} \underline{w}$

2 Cases to consider, since ω should be ω_0 :

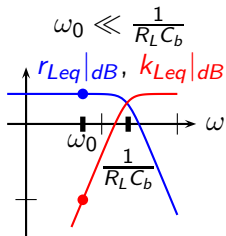

$r_{Leq} \simeq R_L$ and $k_{Leq} \simeq 0$, no problem,
 just use the assumption

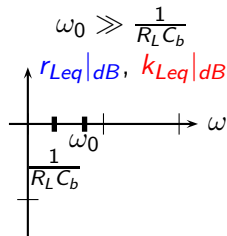

For a real Generator, $D_s \neq 0$ and $v \neq -R_L i_m$

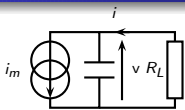

We can show:

$$\underline{v} = -\frac{R_L}{1+j\omega R_L C_b} \underline{i}_m = -j\omega N R_L \frac{1-j\omega R_L C_b}{1+(R_L C_b \omega)^2} \underline{w}_m$$

and we write: $\underline{v} = -j\omega N r_{Leq} \underline{w} - N k_{eq} \underline{w}$

2 Cases to consider, since ω should be ω_0 :

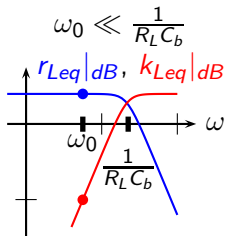

$r_{Leq} \simeq R_L$ and $k_{Leq} \simeq 0$, no problem,
 just use the assumption

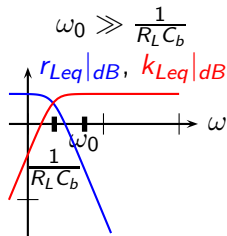

For a real Generator, $D_s \neq 0$ and $v \neq -R_L i_m$

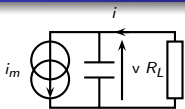

We can show:

$$\underline{v} = -\frac{R_L}{1+j\omega R_L C_b} \underline{i}_m = -j\omega N R_L \frac{1-j\omega R_L C_b}{1+(R_L C_b \omega)^2} \underline{w}_m$$

and we write: $\underline{v} = -j\omega N r_{Leq} \underline{w} - N k_{eq} \underline{w}$

2 Cases to consider, since ω should be ω_0 :

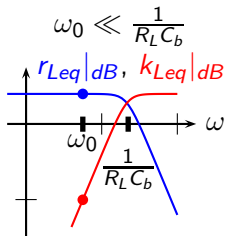

$r_{Leq} \simeq R_L$ and $k_{Leq} \simeq 0$, no problem,
 just use the assumption

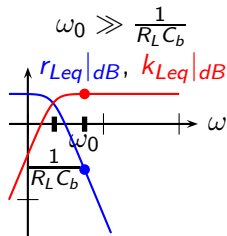

For a real Generator, $D_s \neq 0$ and $v \neq -R_L i_m$

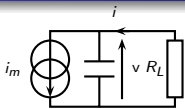

We can show:

$$\underline{v} = -\frac{R_L}{1+j\omega R_L C_b} \underline{i}_m = -j\omega N R_L \frac{1-j\omega R_L C_b}{1+(R_L C_b \omega)^2} \underline{w}_m$$

and we write: $\underline{v} = -j\omega N r_{Leq} \underline{w} - N k_{eq} \underline{w}$

2 Cases to consider, since ω should be ω_0 :

$$\omega_0 \ll \frac{1}{R_L C_b}$$

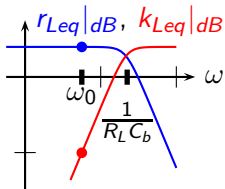

$r_{Leq} \simeq R_L$ and $k_{Leq} \simeq 0$, no problem,
just use the assumption

$$\omega_0 \gg \frac{1}{R_L C_b}$$

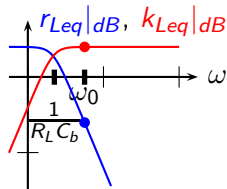

$r_{Leq} \ll R_L$ and k_{Leq} is high, an other
study is needed

For a real Generator, $D_s \neq 0$ and $v \neq -R_L i_m$

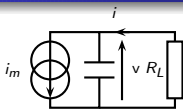

We can show:

$$\underline{v} = -\frac{R_L}{1+j\omega R_L C_b} \underline{i}_m = -j\omega N R_L \frac{1-j\omega R_L C_b}{1+(R_L C_b \omega)^2} \underline{w}_m$$

and we write: $\underline{v} = -j\omega N r_{Leq} \underline{w} - N k_{eq} \underline{w}$

2 Cases to consider, since ω should be ω_0 :

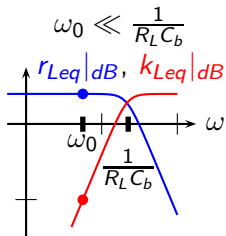

$r_{Leq} \simeq R_L$ and $k_{Leq} \simeq 0$, no problem,
 just use the assumption

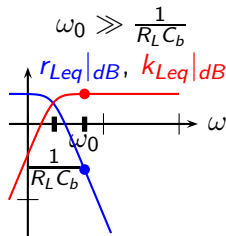

$r_{Leq} \ll R_L$ and k_{Leq} is high, an other
 study is needed

$$((K_s + N^2 k_{eq}) - M\omega^2) + j\omega(D_s + N^2 r_{Leq}) \underline{w} = \underline{f}_{acc}$$

Rule of the Thumb

Let R_b defined as $R_b C_b \omega_0 = 1$, $\omega_0 < \frac{1}{R_L C_b} \rightarrow R_L < R_b$

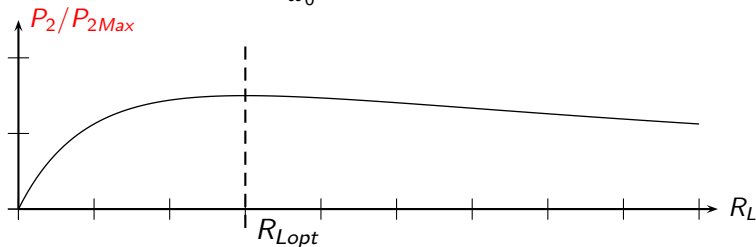
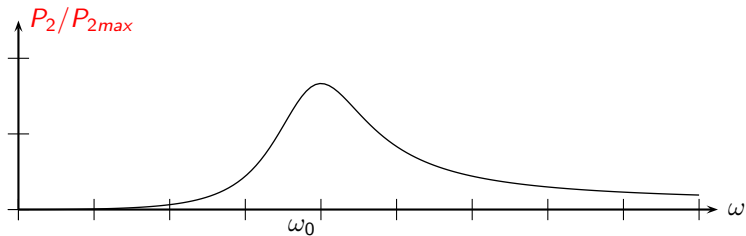

Rule of the Thumb

Let R_b defined as $R_b C_b \omega_0 = 1$, $\omega_0 < \frac{1}{R_L C_b} \rightarrow R_L < R_b$

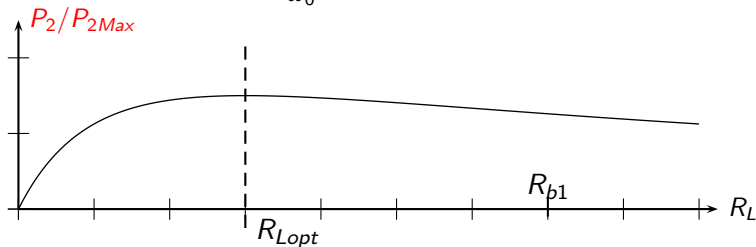
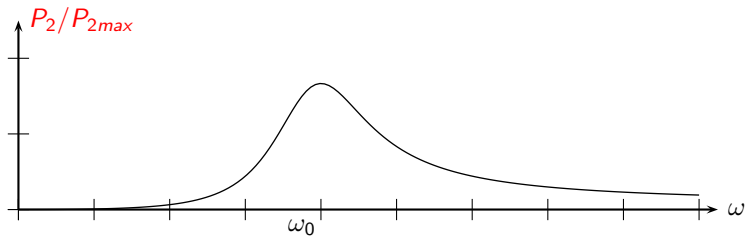

Rule of the Thumb

Let R_b defined as $R_b C_b \omega_0 = 1$, $\omega_0 < \frac{1}{R_L C_b} \rightarrow R_L < R_b$

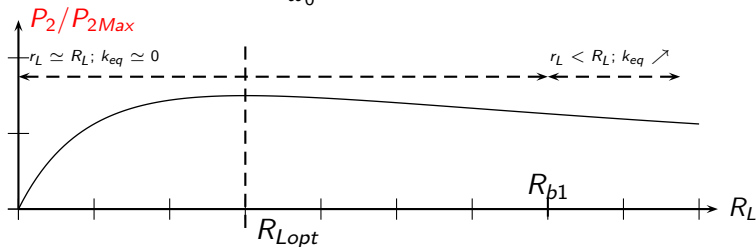
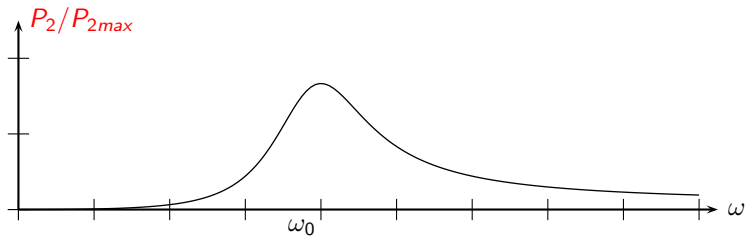

Rule of the Thumb

Let R_b defined as $R_b C_b \omega_0 = 1$, $\omega_0 < \frac{1}{R_L C_b} \rightarrow R_L < R_b$

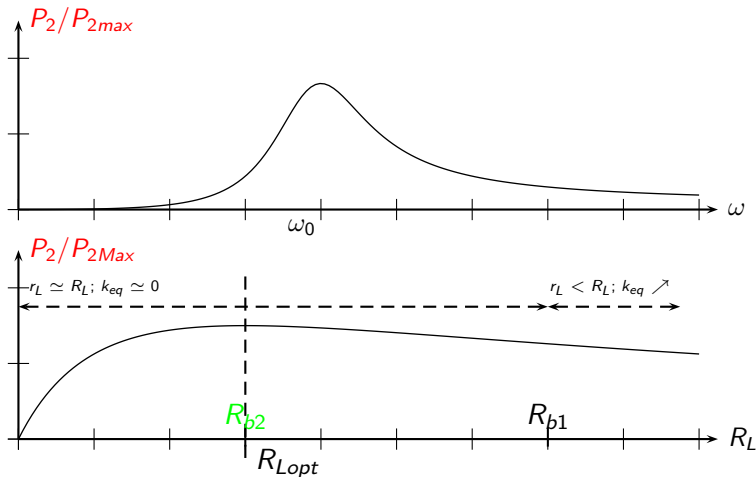

Rule of the Thumb

Let R_b defined as $R_b C_b \omega_0 = 1$, $\omega_0 < \frac{1}{R_L C_b} \rightarrow R_L < R_b$

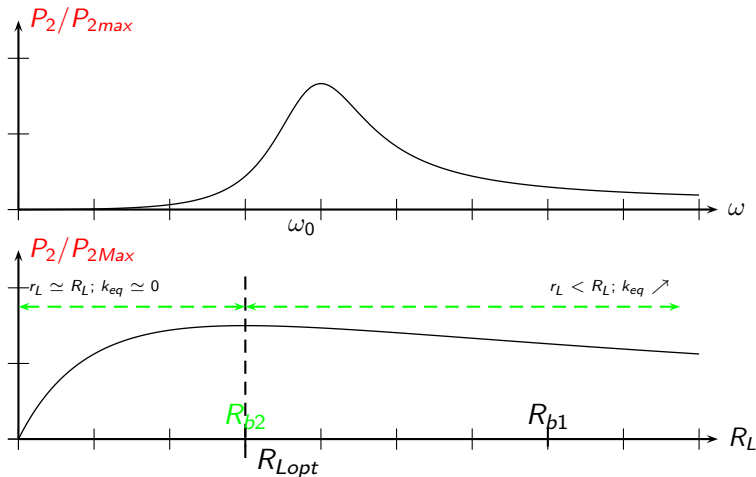

Rule of the Thumb

Let R_b defined as $R_b C_b \omega_0 = 1$, $\omega_0 < \frac{1}{R_L C_b} \rightarrow R_L < R_b$

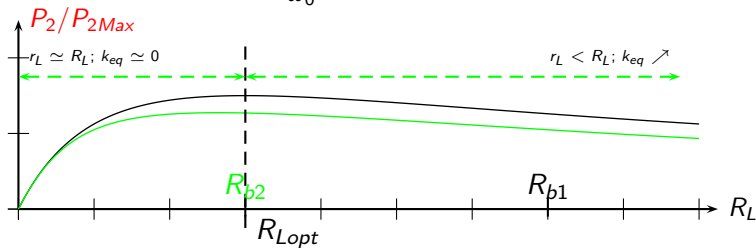
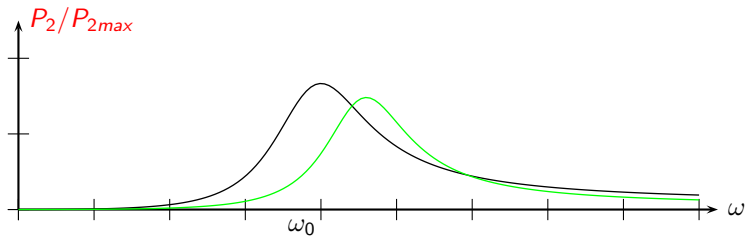

Rule of the Thumb

Let R_b defined as $R_b C_b \omega_0 = 1$, $\omega_0 < \frac{1}{R_L C_b} \rightarrow R_L < R_b$

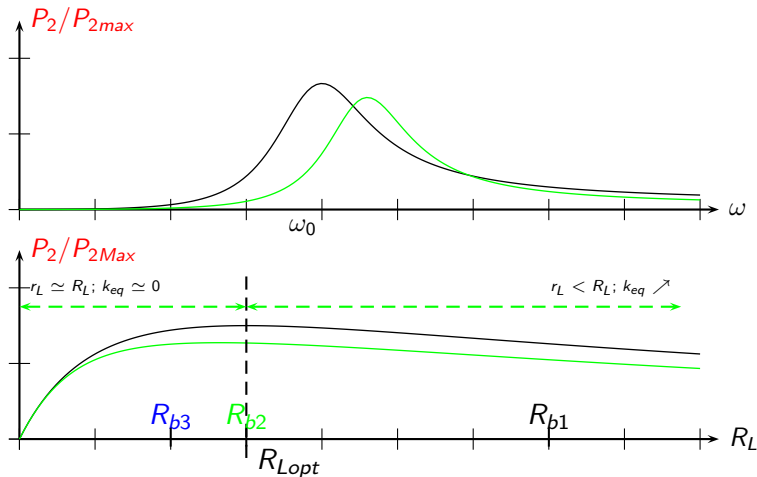

Rule of the Thumb

Let R_b defined as $R_b C_b \omega_0 = 1$, $\omega_0 < \frac{1}{R_L C_b} \rightarrow R_L < R_b$

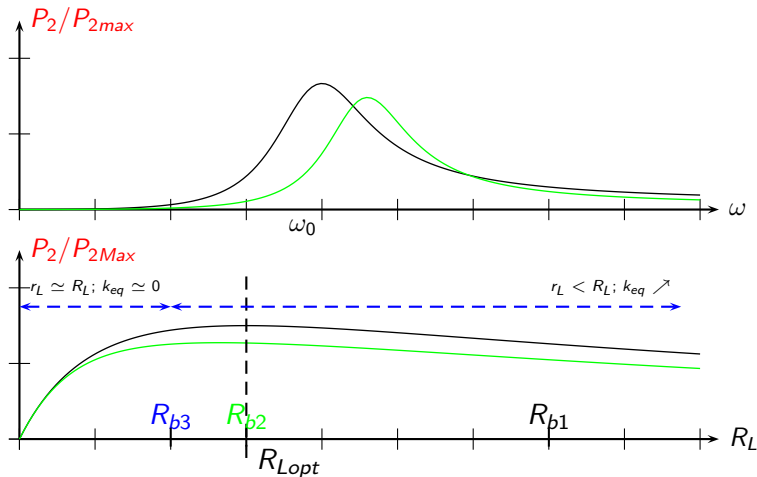

Rule of the Thumb

Let R_b defined as $R_b C_b \omega_0 = 1$, $\omega_0 < \frac{1}{R_L C_b} \rightarrow R_L < R_b$

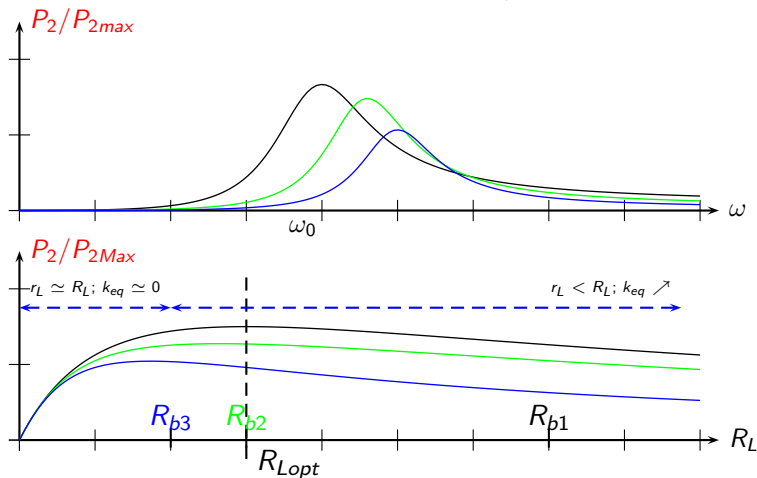

Rule of the Thumb

Let R_b defined as $R_b C_b \omega_0 = 1$, $\omega_0 < \frac{1}{R_L C_b} \rightarrow R_L < R_b$

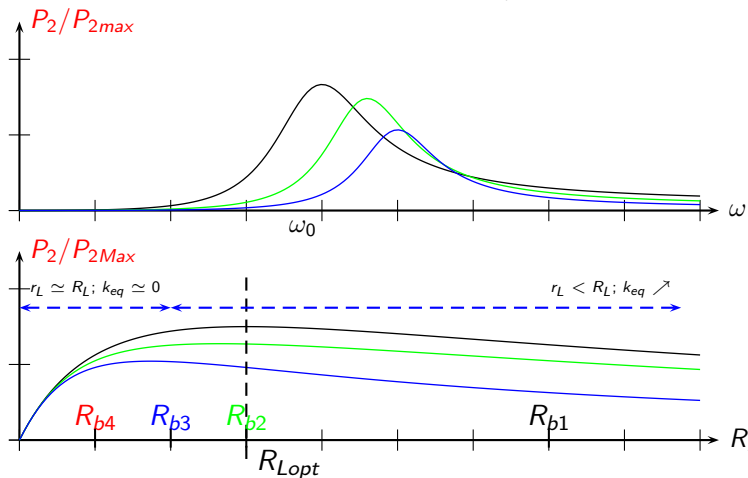

Rule of the Thumb

Let R_b defined as $R_b C_b \omega_0 = 1$, $\omega_0 < \frac{1}{R_L C_b} \rightarrow R_L < R_b$

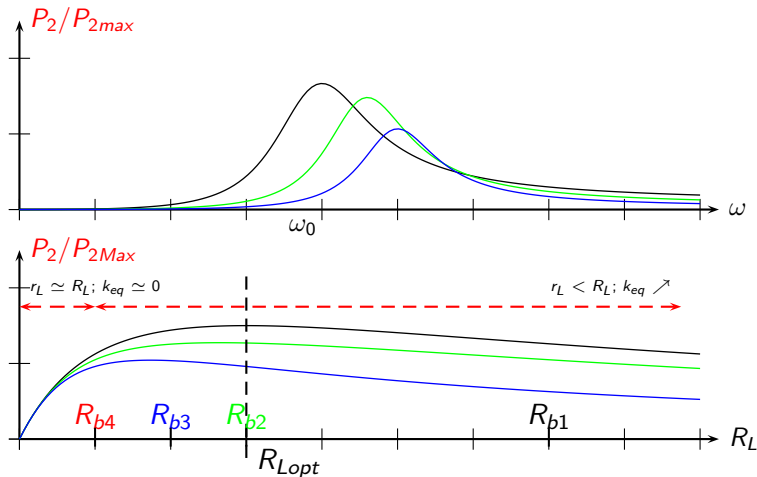

Rule of the Thumb

Let R_b defined as $R_b C_b \omega_0 = 1$, $\omega_0 < \frac{1}{R_L C_b} \rightarrow R_L < R_b$

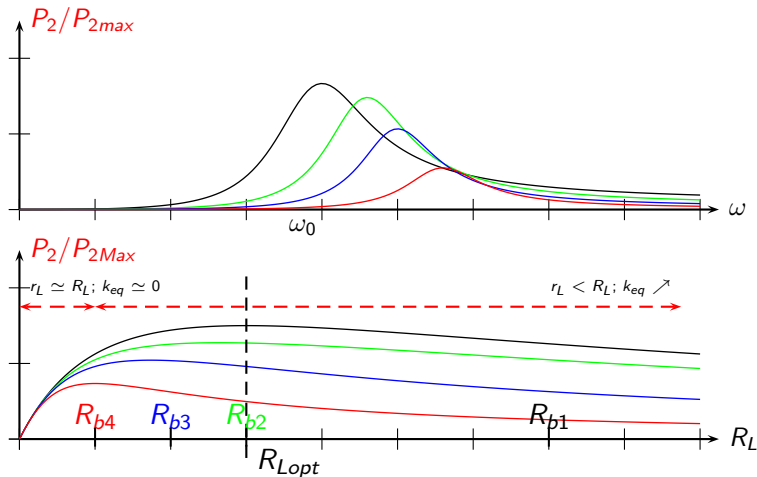

Partial Conclusion

If $R_{opt} < R_b$

A resistor can recover the power optimally. But the study was not valid for high R_L . What happens for $R_L \gg R_b$?

Partial Conclusion

If $R_{opt} < R_b$

A resistor can recover the power optimally. But the study was not valid for high R_L . What happens for $R_L \gg R_b$?

If $R_{opt} > R_b$

The power is not well extracted because $P_2 < P_{2max}$. This happens for high damped mechanisms.

A simple resistor cannot recover the power optimally (and this is due to C_b).

What happens if $R_{opt} < R_b$ and $R_L \gg R_b$?

resonance is shifted

- $r_{Leq} = \frac{R_L}{1+(R_L C_b \omega)^2} \simeq \frac{R_L}{(R_L C_b \omega)^2}$

- $k_{eq} = R_L \frac{\omega^2 R_L C_b}{1+(R_L C_b \omega)^2} \simeq \frac{1}{C_b}$

$((K_s + N^2 k_{eq}) - M\omega^2) + j\omega(D_s + N^2 r_{Leq})\underline{w} = \underline{f}_{acc}$ leads to:

$$\omega'_0 = \sqrt{\frac{K_s + N^2 k_{eq}}{M}} = \sqrt{\frac{K_s + \frac{N^2}{C_b}}{M}}$$

What happens if $R_{opt} < R_b$ and $R_L \gg R_b$?

resonance is shifted

- $r_{Leq} = \frac{R_L}{1+(R_L C_b \omega)^2} \simeq \frac{R_L}{(R_L C_b \omega)^2}$

- $k_{eq} = R_L \frac{\omega^2 R_L C_b}{1+(R_L C_b \omega)^2} \simeq \frac{1}{C_b}$

$((K_s + N^2 k_{eq}) - M\omega^2) + j\omega(D_s + N^2 r_{Leq})\underline{w} = \underline{f}_{acc}$ leads to:

$$\omega'_0 = \sqrt{\frac{K_s + N^2 k_{eq}}{M}} = \sqrt{\frac{K_s + \frac{N^2}{C_b}}{M}}$$

Another optimal resistor

The optimal power is harvested is $N^2 r_{Leq} = D_s$, leading to:

$$\frac{N^2 R_L}{(R_L C_b \omega'_0)^2} = \frac{N^2}{R_L C_b^2 \frac{K_s + \frac{N^2}{C_b}}{M}} = D_s$$

$$R_{Lopt2} = \frac{N^2}{D_s} \frac{1}{C_b^2 \frac{K_s}{M} (1 + \frac{N^2}{K_s C_b})} = \frac{R_b^2}{R_{Lopt}} \frac{1}{1 + \frac{N^2}{K_s C_b}}$$

What happens if $R_{opt} < R_b$ and $R_L \gg R_b$?

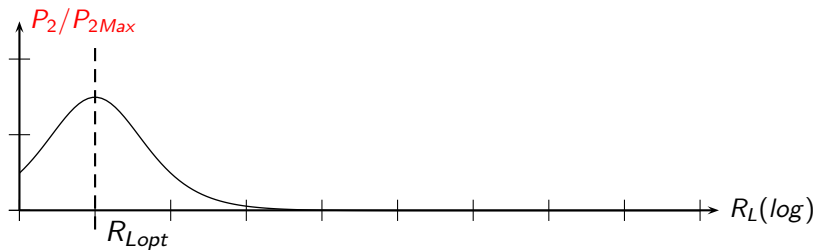

What happens if $R_{opt} < R_b$ and $R_L \gg R_b$?

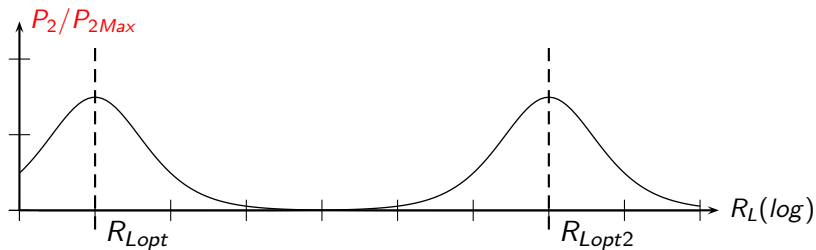

Conclusion

- For the realistic case, there is one or two resistive loads which allow to extract the maximum of power,

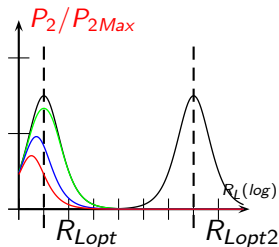

Conclusion

- For the realistic case, there is one or two resistive loads which allow to extract the maximum of power,
- There exist an optimal frequency which may vary if R_L is very high,

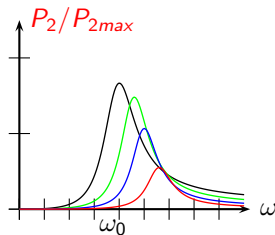
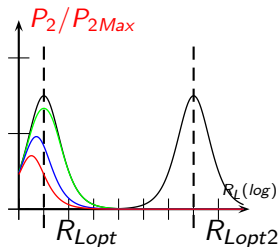

Conclusion

- For the realistic case, there is one or two resistive loads which allow to extract the maximum of power,
- There exist an optimal frequency which may vary if R_L is very high,
- For highly damped structure, a simple resistor is not optimal.

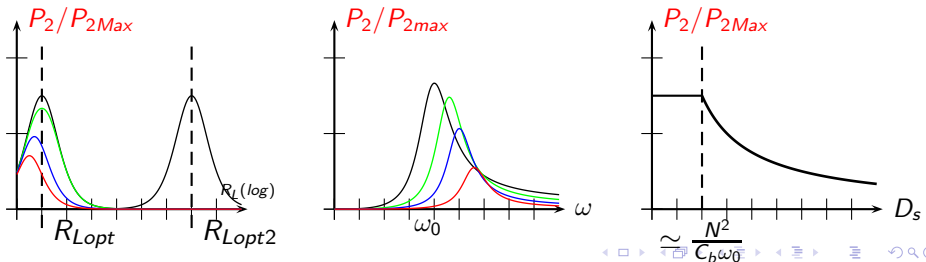

Conclusion

- For the realistic case, there is one or two resistive loads which allow to extract the maximum of power,
 - There exist an optimal frequency which may vary if R_L is very high,
 - For highly damped structure, a simple resistor is not optimal.
- we always want to harvest the maximum of power!

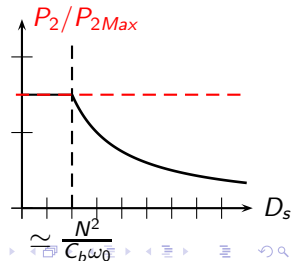
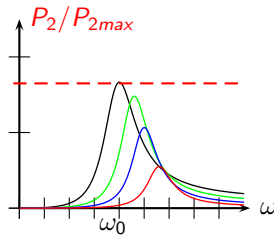
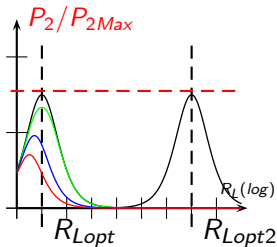
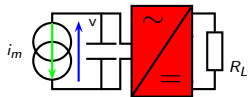

Table of contents

- 1 Introduction
 - What is Energy Harvesting ?
 - Generator Technologies
 - Summary
- 2 Modelling of a piezoelectric energy harvester
 - Presentation of the system
 - EMR of the system
 - Power Extraction on a load resistor R_L from harmonic oscillation
- 3 An Example of inverter
 - Introduction
 - SSHI: Synchronized Switch Harvesting on Inductor

Introduction



Introduction

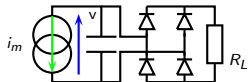

Introduction

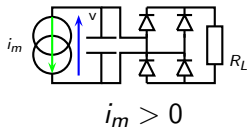

Introduction

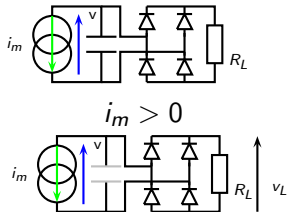

Introduction

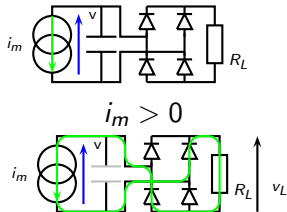

Introduction

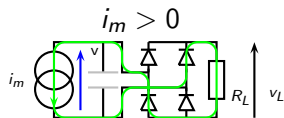
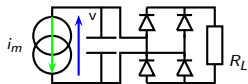

$$v_L = R_L i_m \text{ which is } > 0$$

$$\text{and } v = -v_L = -R_L i_m$$

Introduction

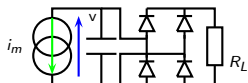

$$i_m > 0$$

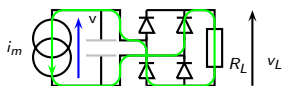

$$v_L = R_L i_m \text{ which is } > 0$$

$$\text{and } v = -v_L = -R_L i_m$$

$$i_m < 0$$

Introduction

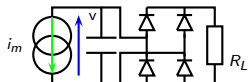

$$i_m > 0$$

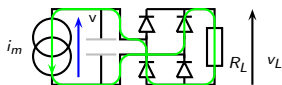

$$v_L = R_L i_m \text{ which is } > 0$$

$$\text{and } v = -v_L = -R_L i_m$$

$$i_m < 0$$

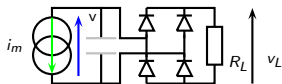

Introduction

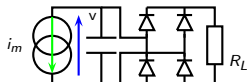

$$i_m > 0$$

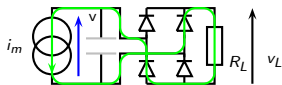

$$v_L = R_L i_m \text{ which is } > 0$$

$$\text{and } v = -v_L = -R_L i_m$$

$$i_m < 0$$

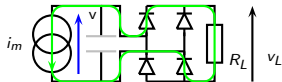

Introduction

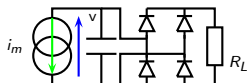

$$i_m > 0$$

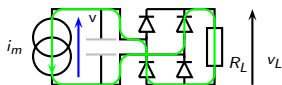

$$v_L = R_L i_m \text{ which is } > 0$$

$$\text{and } v = -v_L = -R_L i_m$$

$$i_m < 0$$

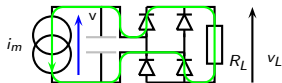

$$v_L = -R_L i_m \text{ which is } > 0$$

$$\text{again, and}$$

$$v = v_L = -R_L i_m$$

Introduction

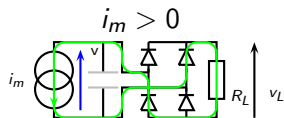
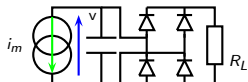

$v_L = R_L i_m$ which is > 0
and $v = -v_L = -R_L i_m$

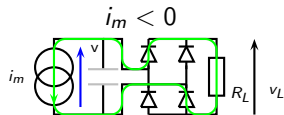

$v_L = -R_L i_m$ which is > 0
again, and
 $v = v_L = -R_L i_m$

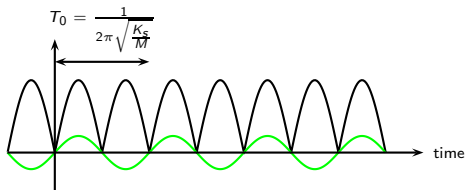

Introduction

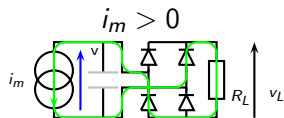
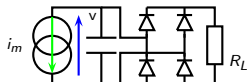

$$v_L = R_L i_m \text{ which is } > 0$$

$$\text{and } v = -v_L = -R_L i_m$$

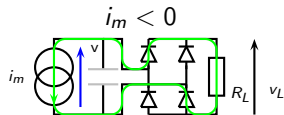

$$v_L = -R_L i_m \text{ which is } > 0$$

again, and

$$v = v_L = -R_L i_m$$

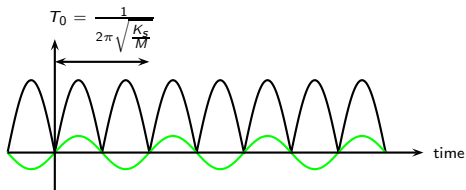

The current is rectified, but we still have $v = -R_L i_m$: Power harvesting depends on R_L

Introduction

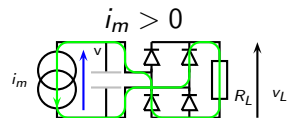
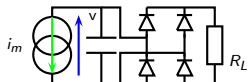

$$v_L = R_L i_m \text{ which is } > 0$$

$$\text{and } v = -v_L = -R_L i_m$$

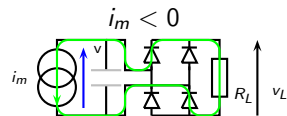

$$v_L = -R_L i_m \text{ which is } > 0$$

again, and

$$v = v_L = -R_L i_m$$

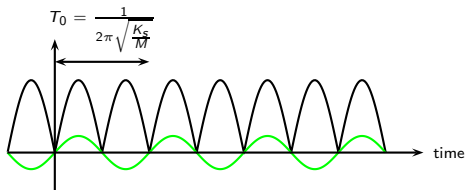

The current is rectified, but we still have $v = -R_L i_m$: Power harvesting depends on R_L
Moreover, it is still not optimal if $R_{opt} > R_b$.

Introduction

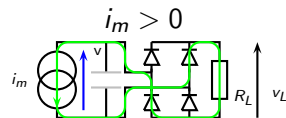
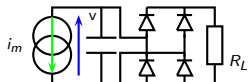

$$v_L = R_L i_m \text{ which is } > 0$$

$$\text{and } v = -v_L = -R_L i_m$$

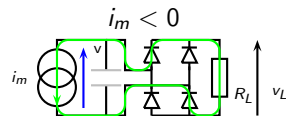

$$v_L = -R_L i_m \text{ which is } > 0$$

again, and

$$v = v_L = -R_L i_m$$

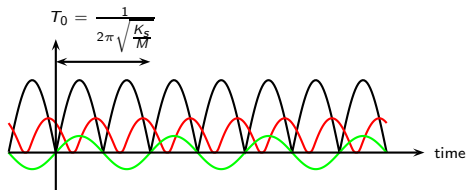

The current is rectified, but we still have $v = -R_L i_m$: Power harvesting depends on R_L
Moreover, it is still not optimal if $R_{opt} > R_b$.

Introduction

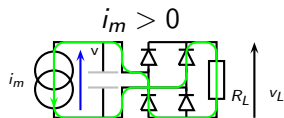
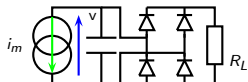

$$v_L = R_L i_m \text{ which is } > 0$$

$$\text{and } v = -v_L = -R_L i_m$$

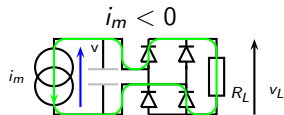

$$v_L = -R_L i_m \text{ which is } > 0$$

$$\text{again, and}$$

$$v = v_L = -R_L i_m$$

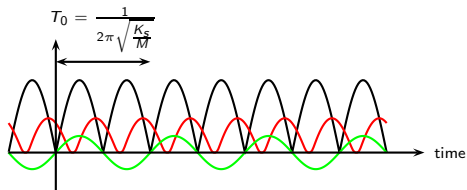

The current is rectified, but we still have $v = -R_L i_m$: Power harvesting depends on R_L
Moreover, it is still not optimal if $R_{opt} > R_b$.
This is why, some want to compensate for C_b :

Introduction

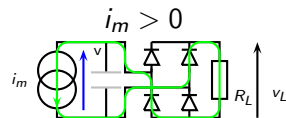
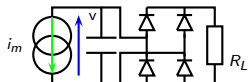

$v_L = R_L i_m$ which is > 0
and $v = -v_L = -R_L i_m$

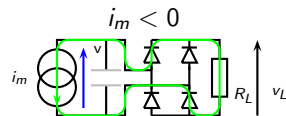

$v_L = -R_L i_m$ which is > 0
again, and
 $v = v_L = -R_L i_m$

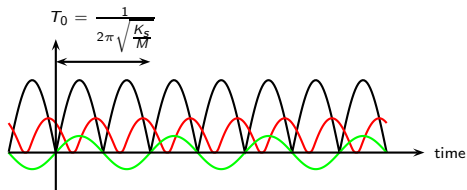

The current is rectified, but we still have $v = -R_L i_m$: Power harvesting depends on R_L
Moreover, it is still not optimal if $R_{opt} > R_b$.
This is why, some want to compensate for C_b :

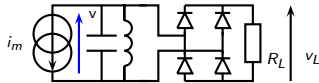

Introduction

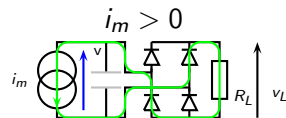
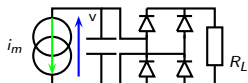

$v_L = R_L i_m$ which is > 0
and $v = -v_L = -R_L i_m$

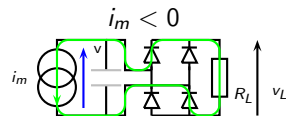

$v_L = -R_L i_m$ which is > 0
again, and
 $v = v_L = -R_L i_m$

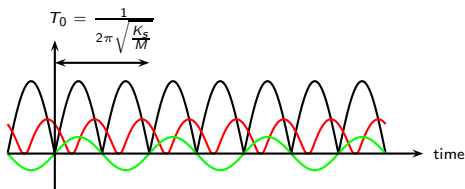

The current is rectified, but we still have $v = -R_L i_m$: Power harvesting depends on R_L
Moreover, it is still not optimal if $R_{opt} > R_b$.
This is why, some want to compensate for C_b :

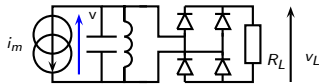

This is a bad solution because it works only for ω_0 (what if the frequency shifts?), and the Inductor is large (because ω_0 usually is small)

Introduction

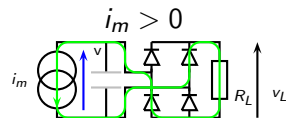
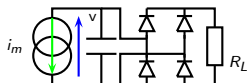

$v_L = R_L i_m$ which is > 0
and $v = -v_L = -R_L i_m$

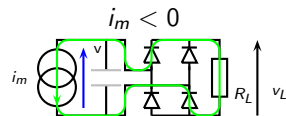

$v_L = -R_L i_m$ which is > 0
again, and
 $v = v_L = -R_L i_m$

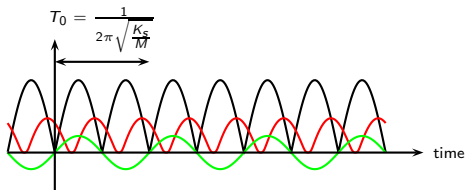

The current is rectified, but we still have
 $v = -R_L i_m$: Power harvesting depends on R_L
Moreover, it is still not optimal if $R_{opt} > R_b$.
This is why, some want to compensate for C_b :

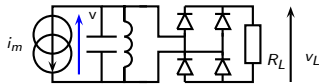

This is a bad solution because it works only for ω_0 (what if the frequency shifts?), and the Inductor is large (because ω_0 usually is small)
→ Non linear Techniques

Why Synchronized

Why Synchronized

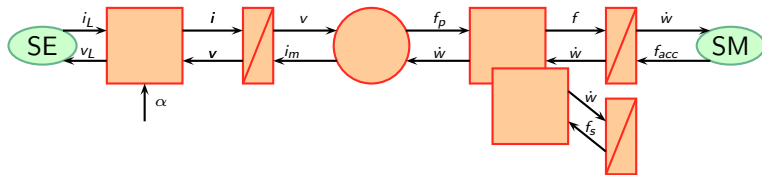

Why Synchronized

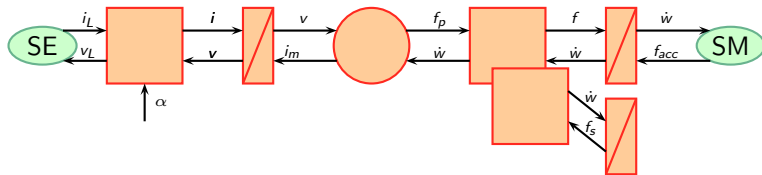

Why Synchronized

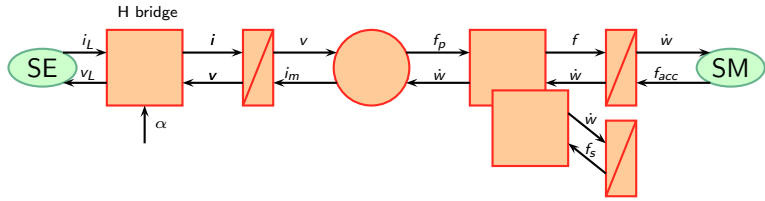

Why Synchronized

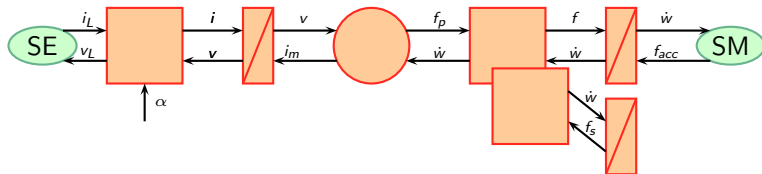

Strategy: $v = -R_{opt}i_m$ leads to $\frac{f_p}{N} = -\frac{D_s}{N^2}N\dot{w}$ or, $f_p = -D_s\dot{w}$.

Why Synchronized

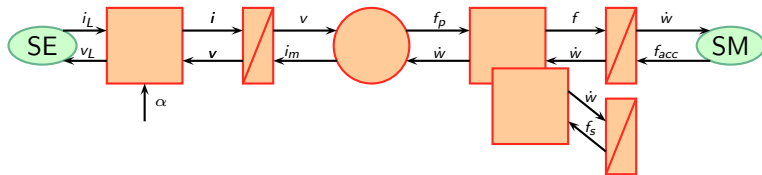

Strategy: $v = -R_{opt}i_m$ leads to $\frac{f_p}{N} = -\frac{D_s}{N^2}N\dot{w}$ or, $f_p = -D_s\dot{w}$.

Why Synchronized

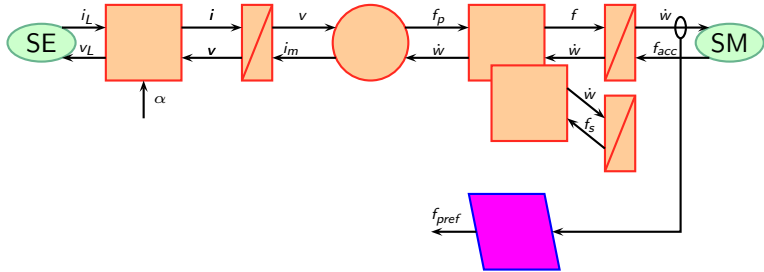

Strategy: $v = -R_{opt}i_m$ leads to $\frac{f_p}{N} = -\frac{D_s}{N^2}N\dot{w}$ or, $f_p = -D_s\dot{w}$.

Why Synchronized

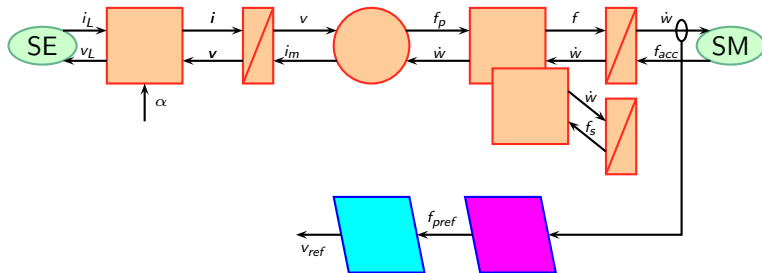

Strategy: $v = -R_{opt}i_m$ leads to $\frac{f_p}{N} = -\frac{D_s}{N^2}N\dot{w}$ or, $f_p = -D_s\dot{w}$.

Why Synchronized

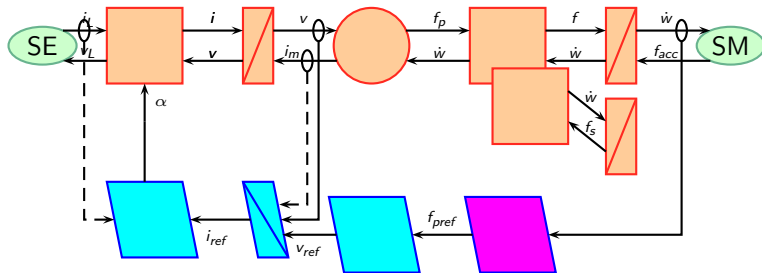

Strategy: $v = -R_{opt} i_m$ leads to $\frac{f_p}{N} = -\frac{D_s}{N^2} N \dot{w}$ or, $f_p = -D_s \dot{w}$.
 This shows that v should be controlled.

Why Synchronized

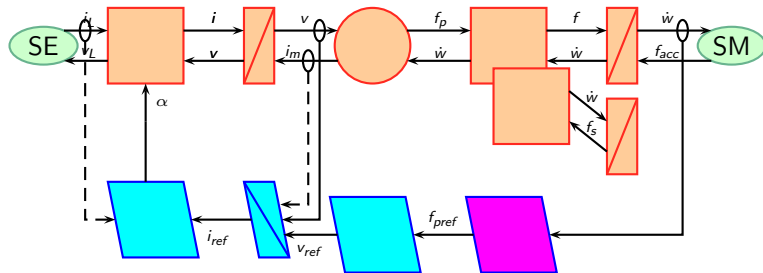

Strategy: $v = -R_{opt} i_m$ leads to $\frac{f_p}{N} = -\frac{D_s}{N^2} N \dot{w}$ or, $f_p = -D_s \dot{w}$.
 This shows that v should be controlled. SSHI does this with efficiency.

How it works

LC oscillations



How it works

LC oscillations

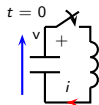

How it works

LC oscillations

$t = 0$

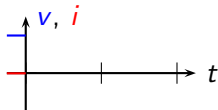
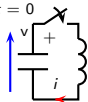

How it works

LC oscillations

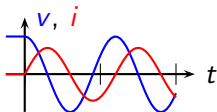
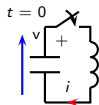

How it works

LC oscillations

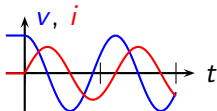
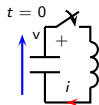

Switched inductor

How it works

LC oscillations

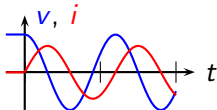
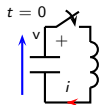

Switched inductor



How it works

LC oscillations

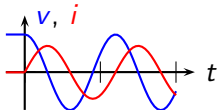
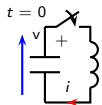

Switched inductor

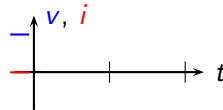
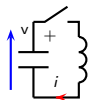

How it works

LC oscillations

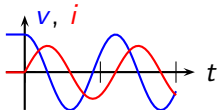
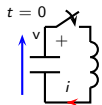

Switched inductor

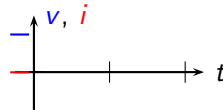

How it works

LC oscillations

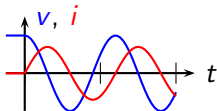
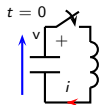

Switched inductor

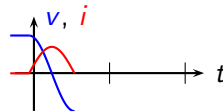

How it works

LC oscillations

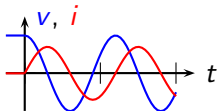
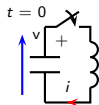

Switched inductor

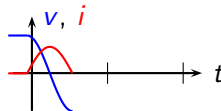
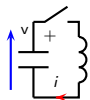

How it works

LC oscillations

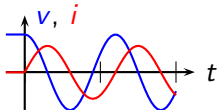
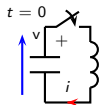

Switched inductor

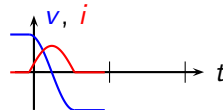
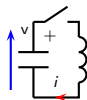

How it works

LC oscillations

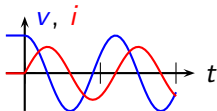
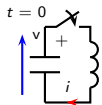

Switched inductor

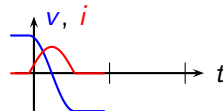

How it works

LC oscillations

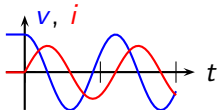
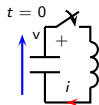

Switched inductor

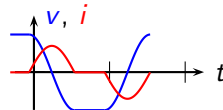

How it works

LC oscillations

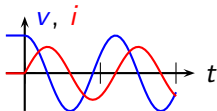
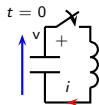

Switched inductor

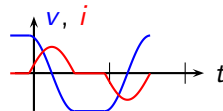
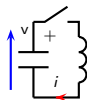

How it works

LC oscillations

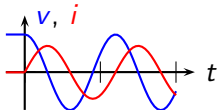
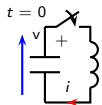

Switched inductor

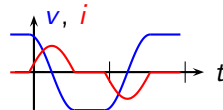
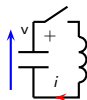

How it works

LC oscillations

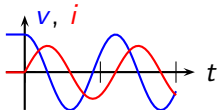
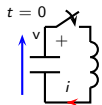

Switched inductor

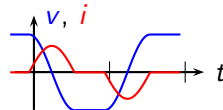
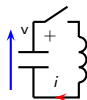

SSHI

How it works

LC oscillations

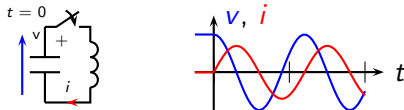

Switched inductor

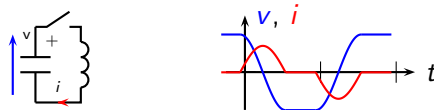

SSHI

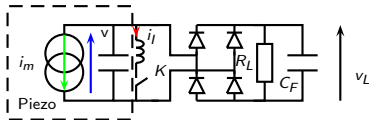

How it works

LC oscillations

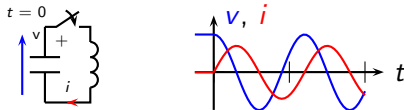

Switched inductor

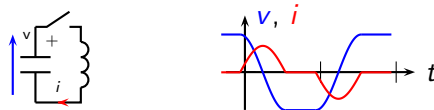

SSHI

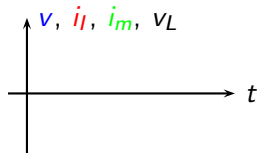
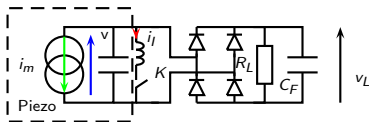

How it works

LC oscillations

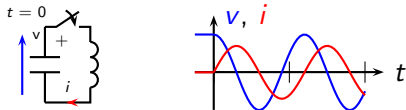

Switched inductor

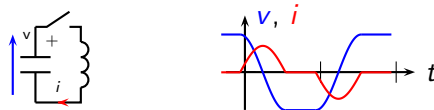

SSHI

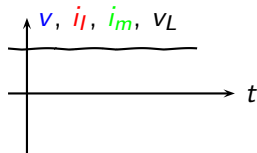
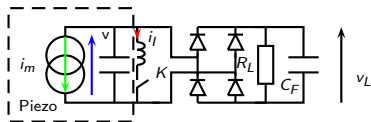

How it works

LC oscillations

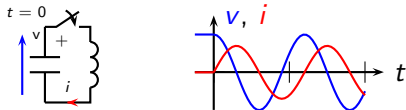

Switched inductor

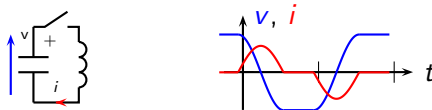

SSHI

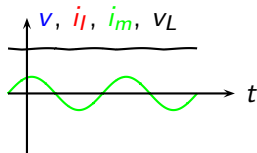
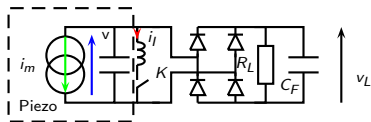

How it works

LC oscillations

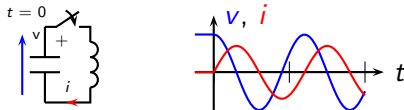

Switched inductor

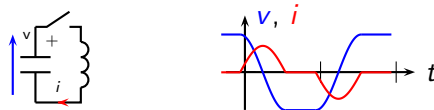

SSHI

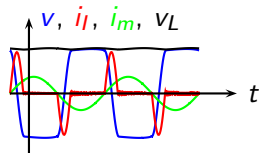
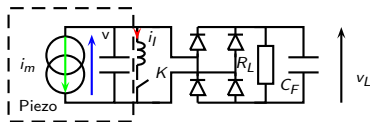

How it works

LC oscillations

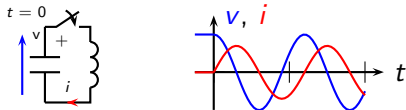

Switched inductor

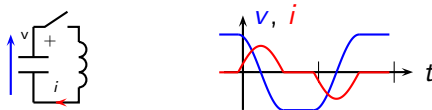

SSHI

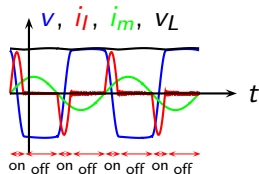
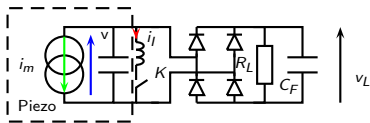

Switching is synchronized on \dot{w} , or

$$i_m = N\dot{w}$$

How it works

LC oscillations

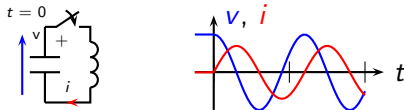

Switched inductor

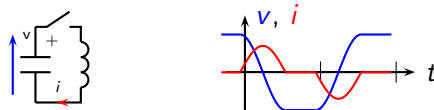

SSHI

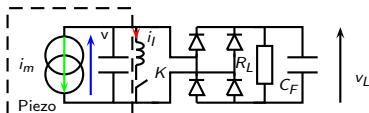

Operating point: calculate v_L from i_m

1st Harmonic assumption: $P = \frac{1}{2} \frac{V_L^2}{R_L} \simeq \frac{1}{2} \frac{4V_L I_m}{\pi}$, $V_L = \frac{4}{\pi} R_L I_m$

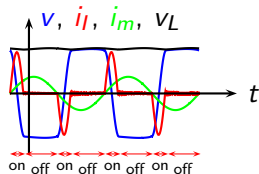

Switching is synchronized on \dot{w} , or

$$i_m = N\dot{w}$$

How it works

LC oscillations

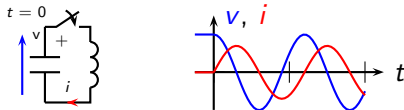

Switched inductor

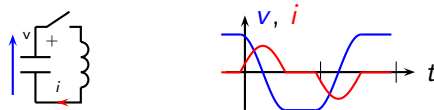

SSHI

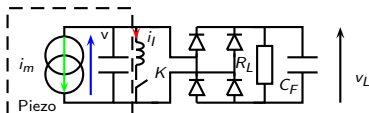

Operating point: calculate v_L from i_m

1st Harmonic assumption: $P = \frac{1}{2} \frac{V_L^2}{R_L} \simeq \frac{1}{2} \frac{4V_L I_m}{\pi}$, $V_L = \frac{4}{\pi} R_L I_m$

SSHI controls v and synchronises it, but doesn't impose $f_p = -D_s \dot{w}$.

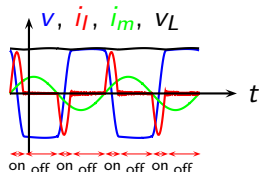

Switching is synchronized on \dot{w} , or

$$i_m = N \dot{w}.$$

Conclusion

Performances

- SSHI can extract energy more efficiently than a resistor when damping is important,

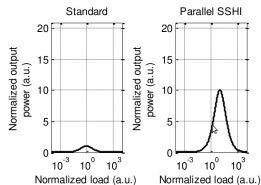
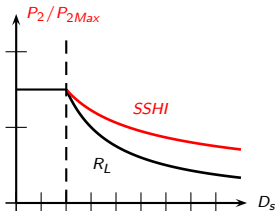

Conclusion

Performances

- SSHI can extract energy more efficiently than a resistor when damping is important,
- But Power extraction still depends on the load,

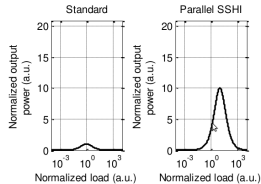
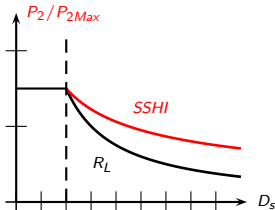

Conclusion

Performances

- SSHI can extract energy more efficiently than a resistor when damping is important,
- But Power extraction still depends on the load,
- Needs to measure bender's deflection $w(t)$.

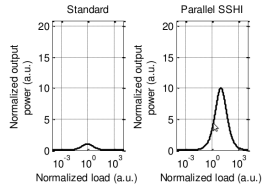
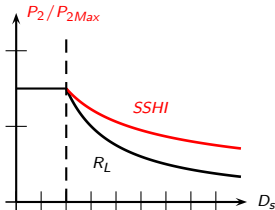

General conclusion



In this presentation, applications of Energy Harvesting were shown. The modelling of a piezoelectric generator has shown that the power source needs an adaptation:

- in frequency,
- in load.

to maximize the harvested power.

The key energy management rules were presented through the analysis of the EMR of the system. A typical power electronic circuit was also presented, but the bibliography shows a lot of example.

References I

-  S Adhikari, M I Friswell, and D J Inman, *Piezoelectric energy harvesting from broadband random vibrations*, Smart Materials and Structures **18** (2009), no. 11, 115005.
-  R. G Ballas, H. F Schlaak, and A. J Schmid, *Closed form analysis of piezoelectric multilayer bending actuators using constituent equations*, The 13th International Conference on Solid-State Sensors, Actuators and Microsystems, 2005. Digest of Technical Papers. TRANSDUCERS '05, vol. 1, IEEE, June 2005, pp. 788–791 Vol. 1.
-  R. Djugum, P. Trivailo, and K. Graves, *A study of energy harvesting from piezoelectrics using impact forces*, The European Physical Journal Applied Physics **48** (2009), no. 1, 11101.
-  Daniel Guyomar, Gal Sebald, Sbastien Pruvost, Mickal Lallart, Akram Khodayari, and Claude Richard, *Energy harvesting from ambient vibrations and heat*, Journal of Intelligent Material Systems and Structures **20** (2009), no. 5, 609–624.
-  Aman Kansal, Jason Hsu, Sadaf Zahedi, and Mani B. Srivastava, *Power management in energy harvesting sensor networks*, ACM Transactions on Embedded Computing Systems **6** (2007), 32–es.
-  Elie Lefeuvre, Adrien Badel, Claude Richard, and Daniel Guyomar, *Piezoelectric energy harvesting device optimization by synchronous electric charge extraction*, Journal of Intelligent Material Systems and Structures **16** (2005), no. 10, 865–876.
-  H. Lhermet, C. Condemine, M. Plissonnier, R. Salot, P. Audebert, and M. Rosset, *Efficient power management circuit: From thermal energy harvesting to above-IC microbattery energy storage*, IEEE Journal of Solid-State Circuits **43** (2008), no. 1, 246–255.

References II



G. A. Lesieutre, G. K. Ottman, and H. F. Hofmann, *Damping as a result of piezoelectric energy harvesting*, Journal of Sound and Vibration **269** (2004), no. 3-5, 991–1001.



D. Niyato, E. Hossain, M. M Rashid, and V. K Bhargava, *Wireless sensor networks with energy harvesting technologies: a game-theoretic approach to optimal energy management*, IEEE Wireless Communications **14** (2007), no. 4, 90–96.



Shad Roundy, Paul Kenneth Wright, and Jan M. Rabaey, *Energy scavenging for wireless sensor networks: with special focus on vibrations*, Springer, 2003.



G. Sebald, E. Lefeuvre, and D. Guyomar, *Pyroelectric energy conversion: Optimization principles*, IEEE Transactions on Ultrasonics, Ferroelectrics and Frequency Control **55** (2008), no. 3, 538–551.



Qing-Ming Wang and L. E Cross, *Constitutive equations of symmetrical triple layer piezoelectric benders*, IEEE Transactions on Ultrasonics, Ferroelectrics and Frequency Control **46** (1999), no. 6, 1343–1351.

End of the presentation

Questions?