



HAL
open science

Multiplexage pour les nuls

Damien Prêle

► **To cite this version:**

| Damien Prêle. Multiplexage pour les nuls. École thématique. France. 2016. hal-03252697

HAL Id: hal-03252697

<https://cel.hal.science/hal-03252697>

Submitted on 23 Aug 2021

HAL is a multi-disciplinary open access archive for the deposit and dissemination of scientific research documents, whether they are published or not. The documents may come from teaching and research institutions in France or abroad, or from public or private research centers.

L'archive ouverte pluridisciplinaire **HAL**, est destinée au dépôt et à la diffusion de documents scientifiques de niveau recherche, publiés ou non, émanant des établissements d'enseignement et de recherche français ou étrangers, des laboratoires publics ou privés.

en préparation du workshop "multiplexage X-IFU" - Sept. 2016

**MULTIPLÉXAGE
POUR
LES NULS**

Damien PRÊLE prele@apc.in2p3.fr

Outline

- 1 Basic multiplexing considerations
- 2 Multiplexing/Demultiplexing of *tones*
- 3 Technological considerations

Multiplexing general

Transmission of N signals over 1 channel

INFORMATION

N data/signals

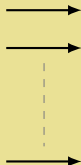

Multiplexer

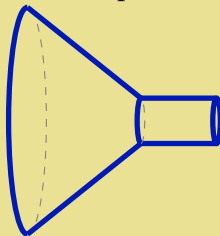

TRANSMISSION

One channel

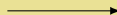

Introduced for telegraphy at the end of the 19th century and widely applied in **telecommunications** during the 20th century :

several telephone calls may be carried using one wire



Multiplexing general

Transmission of N signals over 1 channel

INFORMATION

N data/signals

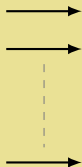

Multiplexer

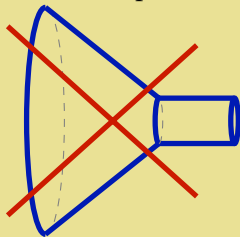

TRANSMISSION

One channel



*That is **not a real multiplexer**, because this need to reduces - **Data compression** - the transmitted informations to use the **same output channel capacity***



Multiplexing general

Transmission of N signals over 1 channel **with HIGHER "capacity"**

INFORMATION

TRANSMISSION

N data/signals

Multiplexer

One channel

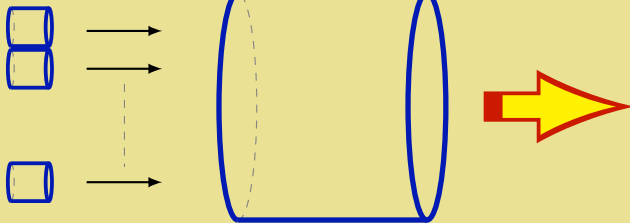

*To transmit N signals via One channel, **the "channel" must provides better performances** than for a single signal transmission.*



Multiplexing notice



To transmit N signals *via* one channel, **the "channel" must provides better performances** than for a single signal transmission.

- ⇒ The increasing of the required performances is directly linked to the number N of multiplexed signals.
- ⇒ The affected performances are both :
 - Band Width
 - Dynamic / Signal to Noise Ratio

the multiplexing **divides the capacity of the high-level communication channel** into several **low-level sub-channels**, one for each message, signal or data to be transmitted.



Multiplexing as a modulation

There are intersections between modulation and multiplexing

Multiplexing = **modulation of input signals by orthogonal signals:**

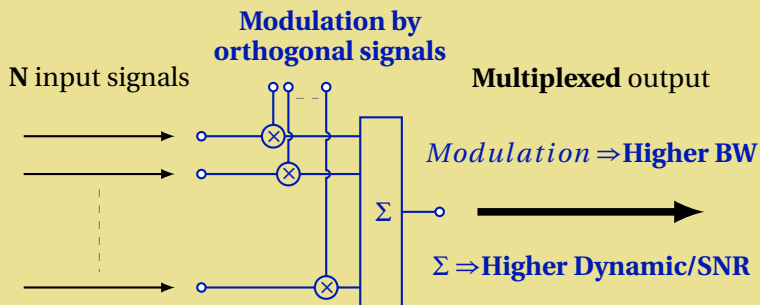

Orthogonal : **boxcar functions** or **carriers at different frequencies**.
 Orthogonality \Rightarrow demultiplexer **able to recover each input signal without interference from the other**.



Orthogonal functions

- boxcar functions \equiv **sampling**

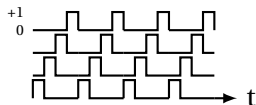

- carriers \equiv **modulation**

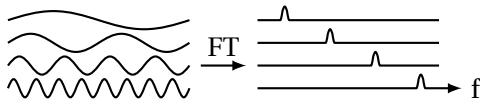

- linear codes* \equiv **coding**

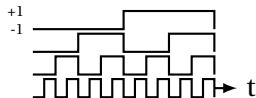

* as used for error-detection/correction code. Especially, Hadamard/Walsh code could be used for multiplexing.



Multiplexing type *vs* standard modulations

- Multiplexing
 - **Time Domain Multiplexing (TDM)**
 - **Frequency Domain Multiplexing (FDM)**
 - Wave length Domain Multiplexing for optical fiber
 - **Coded Domain Multiplexing (CDM)**
- Coding
 - Amplitude Shift Keying (ASK)
 - Frequency Shift Keying (FSK)
 - Coded Division Multiple Access (CDMA)



Code as a third dimension ?

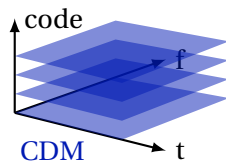
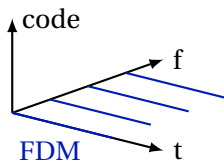
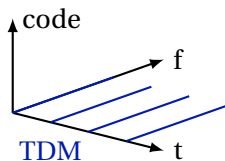

Multiplexing \Rightarrow spread spectrum

- Code is represented as a third dimension even if this is **not necessarily a physical dimension**.
- CDM is usually used to **spread the spectrum** of the multiplexed signal. But the code dimension is often a repartition both in time, in frequency and some times in amplitude.



Time Domain Multiplexing (TDM)

Time slot of **limited duration** of each input signal (S_x) is **summed**

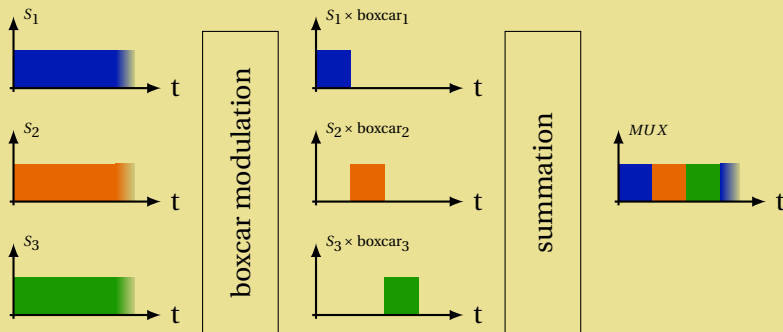

- Requires a specific boxcar (time shifted) modulation / signal
- *Limited duration* \equiv **sampling**

\Rightarrow increasing of the bandwidth
= risk of noise aliasing



Frequency Domain Multiplexing (FDM)

Frequency **transposition** of each input signal (S_x) is **summed**

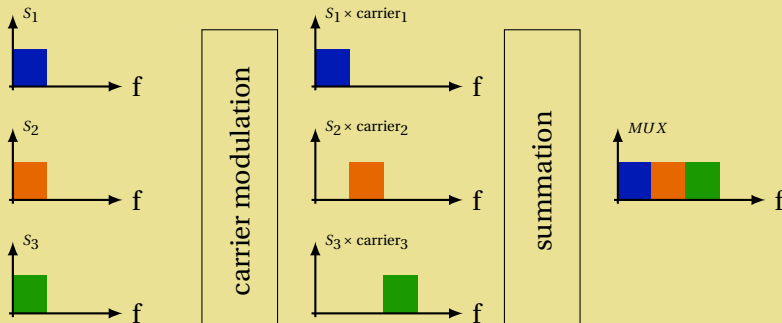

- Requires a specific frequency carrier / signal
- *Summation* \equiv increasing the **bandwidth** and the **dynamic**



Sine waves multiplexing

until now, signal has been represented as a time or freq. *"tophat"*

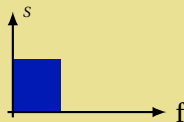

from now, signals will be represented as **4 sine waves**

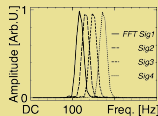
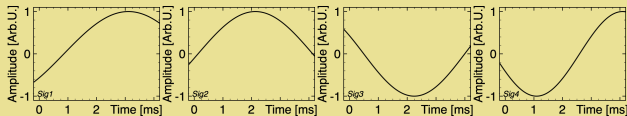

Time Domain/Division Multiplexing - TDM

Modulation - Sampling

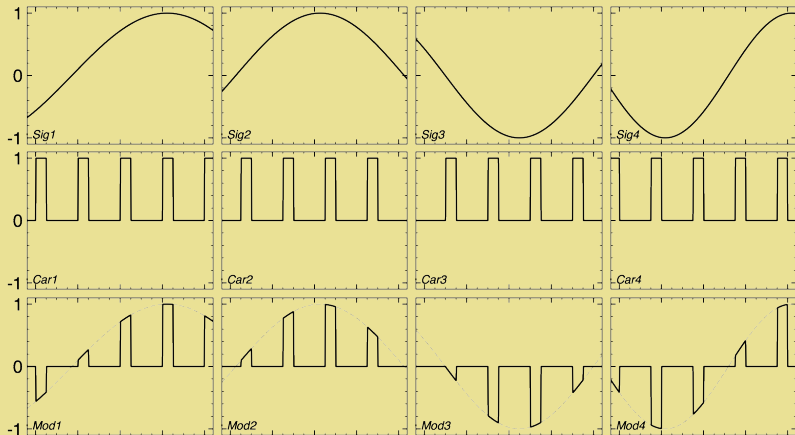

Time Domain/Division Multiplexing - TDM

Summation - multiplexing

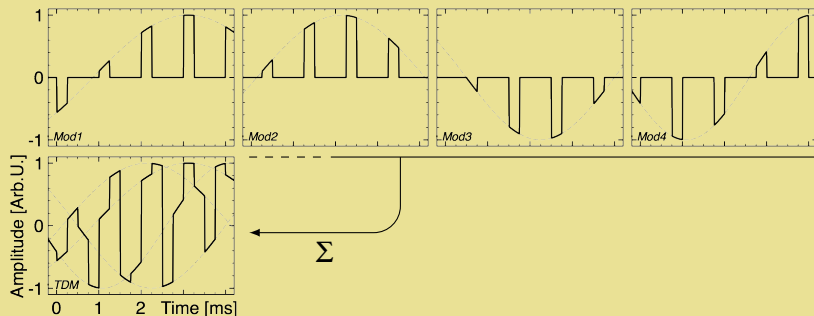

Time Domain/Division Multiplexing - TDM

Spectrum occupancy : $BW_{TDM} > N \times f_s > 2 \times N \times BW_{Sig}$

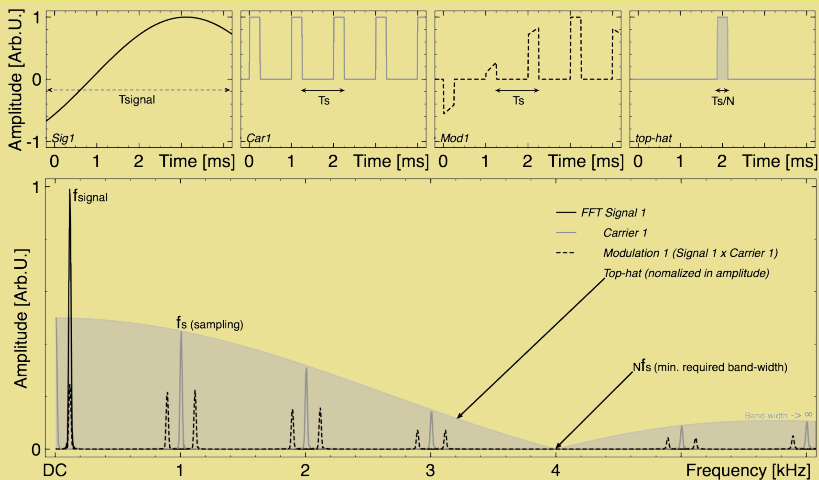

Time Domain/Division Multiplexing - TDM

Shannon-Nyquist Unsatisfied \Rightarrow Alias the unfiltered white noise

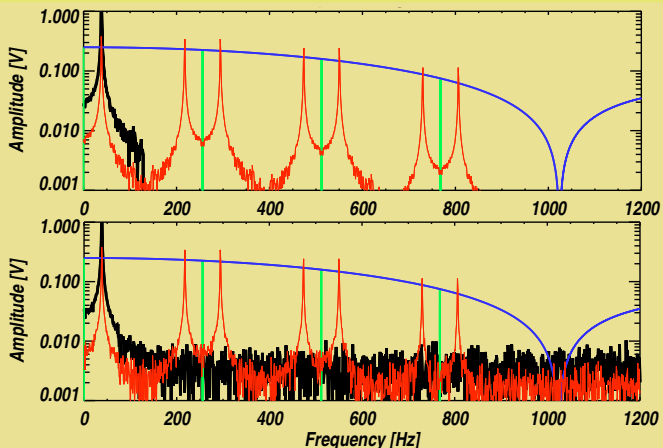

Time Domain/Division Multiplexing - TDM

demultiplexing before sample & hold and filtering

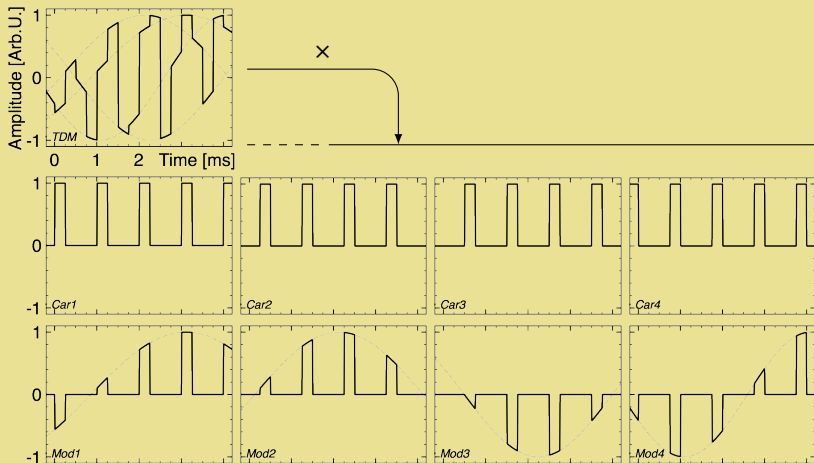

Frequency Domain/Division Multiplexing - FDM

Modulation - Frequency transposition

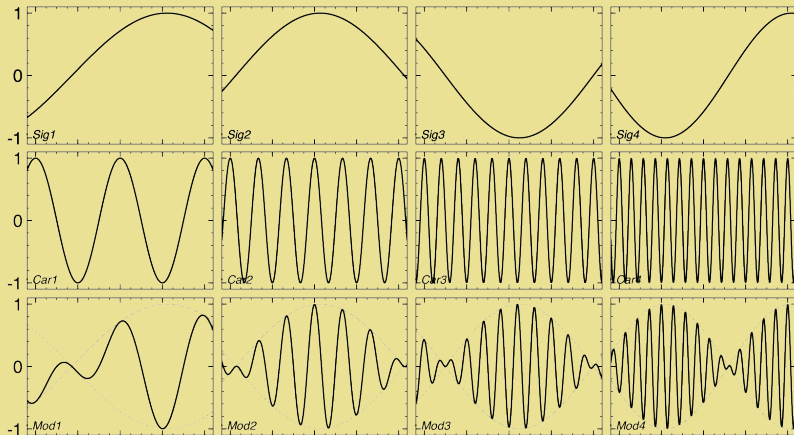

Frequency Domain/Division Multiplexing - FDM

Summation - multiplexing

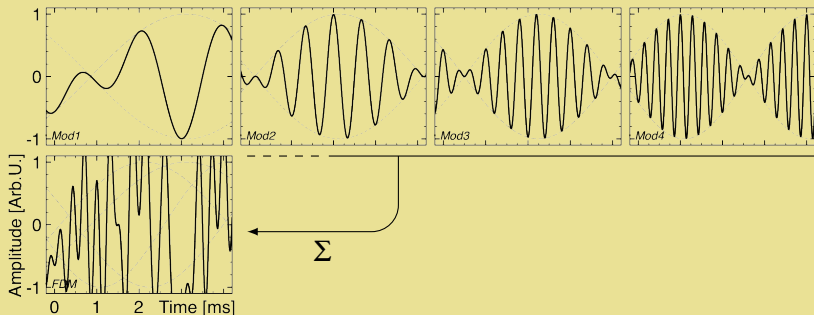

Frequency Domain/Division Multiplexing - FDM

Increasing of the amplitude of the multiplexed signal

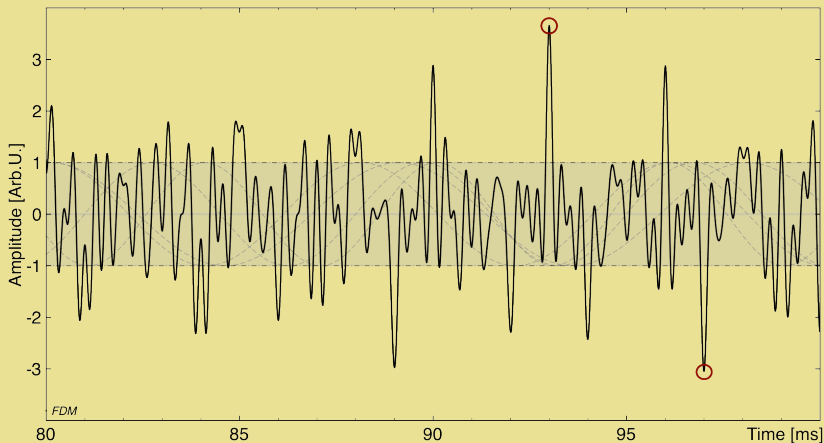

Frequency Domain/Division Multiplexing - FDM

Spectrum occupancy : $BW_{FDM} > 2 \times N \times BW_{Sig}$

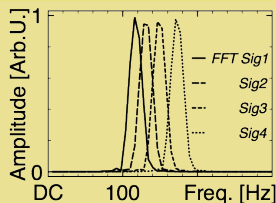

Multiplexing

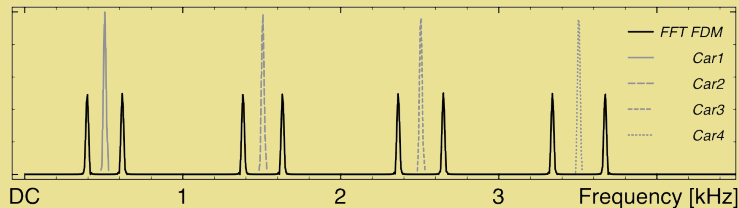

Frequency Domain/Division Multiplexing - FDM

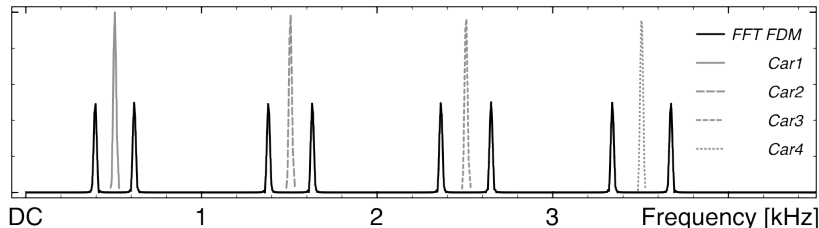

Aliasing of the unfiltered signal and white noise

As for TDM, there is a "Shannon-Nyquist" law (modulation *vs* sampling) which need to limit the signal (and noise) to a bandwidth below an half of the carriers frequency separation



Frequency Domain/Division Multiplexing - FDM

demultiplexing before filtering

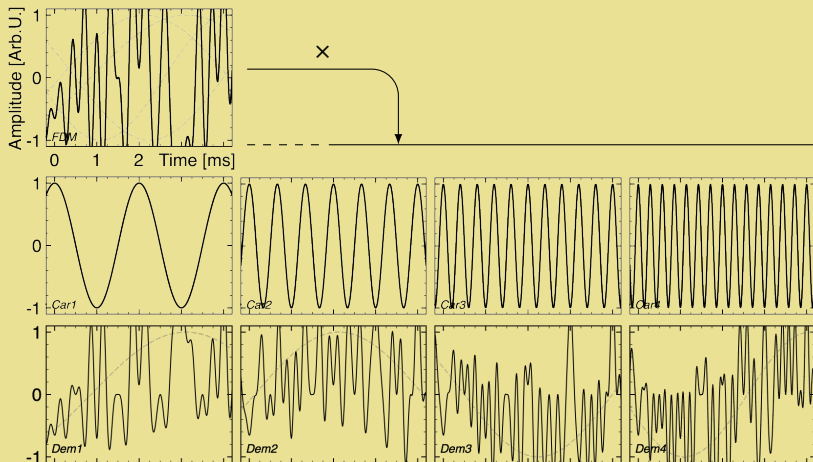

Frequency Domain/Division Multiplexing - FDM

demultiplexing in the frequency domain

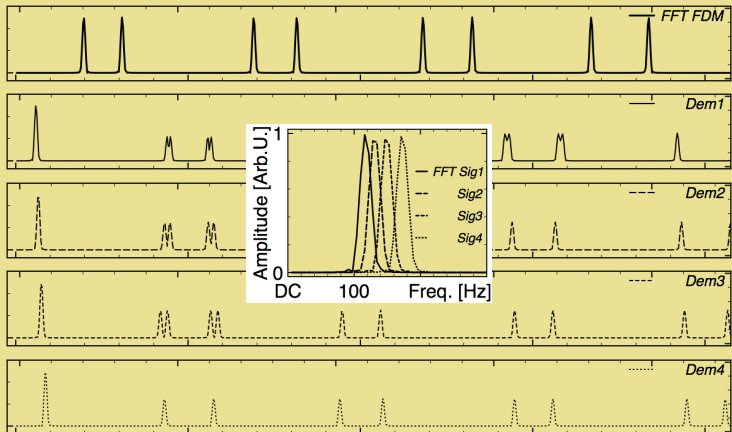

Coded Domain/Division Multiplexing - CDM

Modulation - Coding

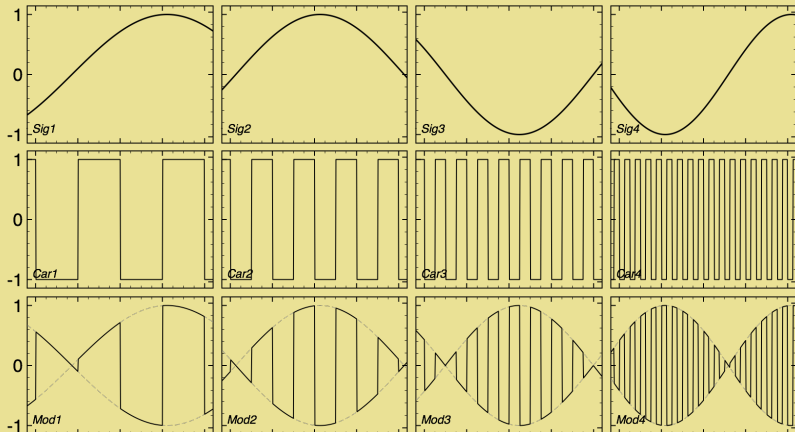

Coded Domain/Division Multiplexing - CDM

Summation - multiplexing

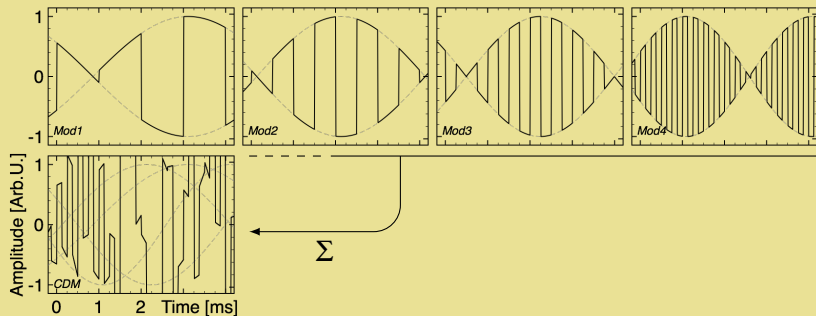

Coded Domain/Division Multiplexing - CDM

Increasing of the amplitude of the multiplexed signal

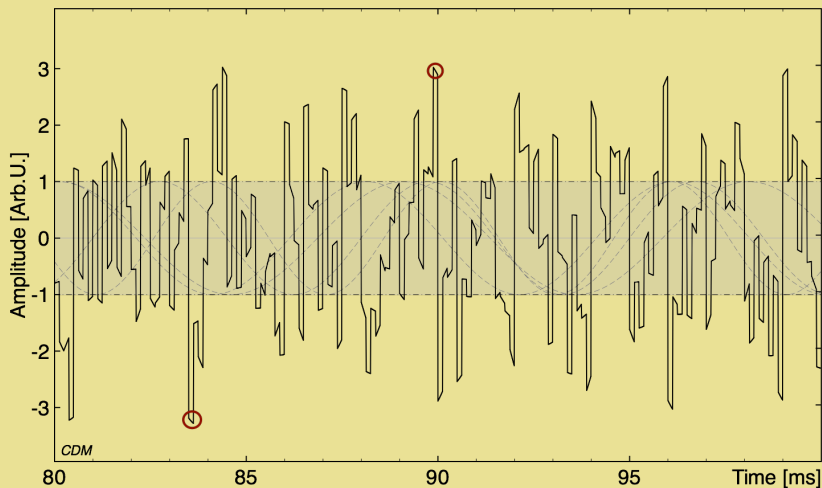

Coded Domain/Division Multiplexing - CDM

Spectrum occupancy : $BW_{FDM} > 2 \times N \times BW_{Sig}$

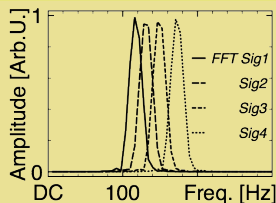

Multiplexing

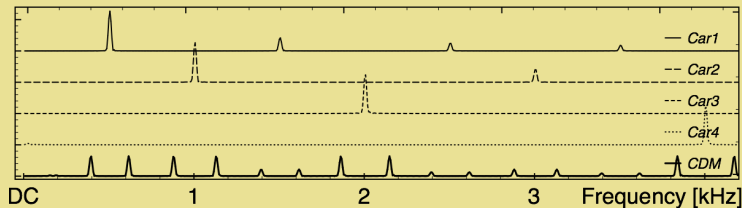

Coded Domain/Division Multiplexing - CDM

Spectrum occupancy : wide "spread" spectrum

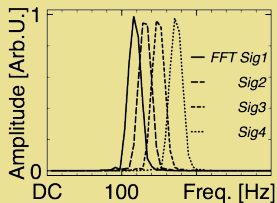

Multiplexing

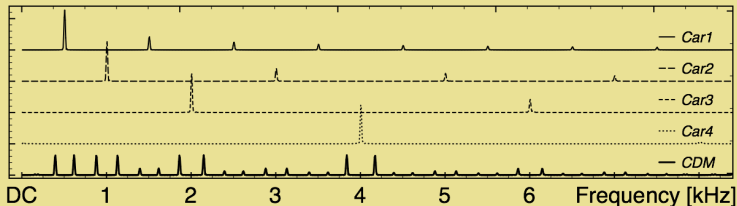

TDM vs FDM principle

Multiplexer 1D

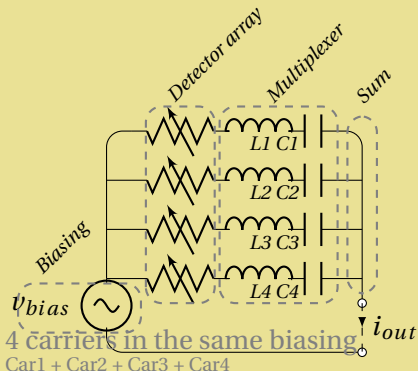
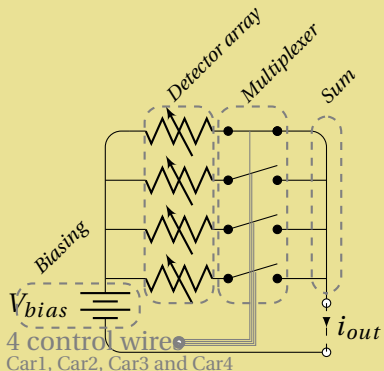

TDM vs FDM with SQUID 1D

Multiplexer 1D

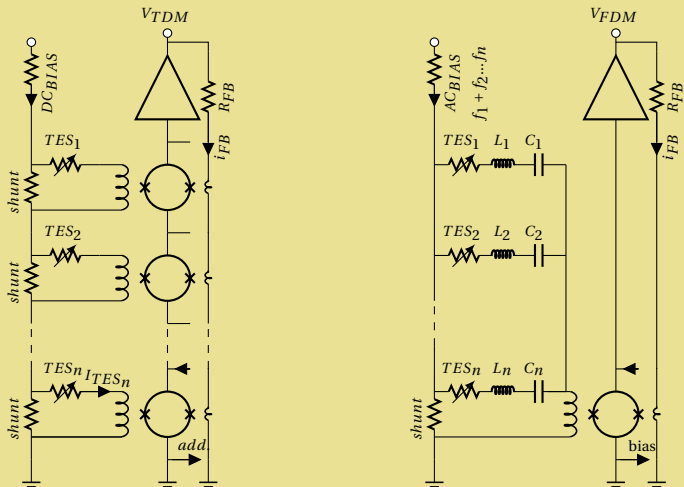

TDM for QUBIC (APC) 2D

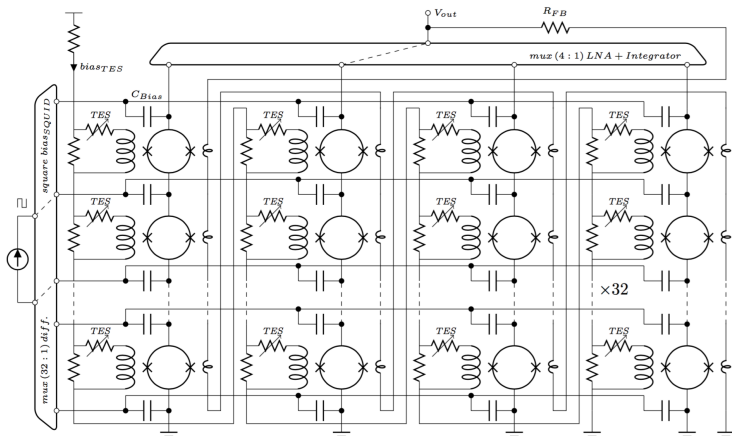

TDM by NIST 2D

Boxcar Modulation Functions (can be from Cryogenic CMOS MUX)

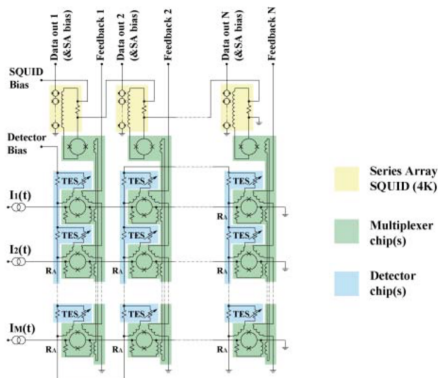
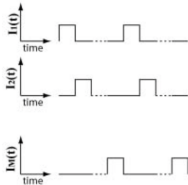

FDM by SRON 1D

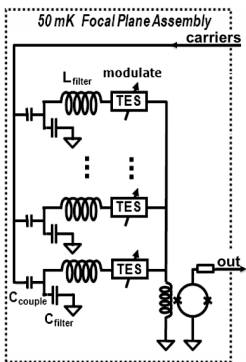

CDM by NIST 1D

