

Quantum Chemistry & Quantum Computing

Saad Yalouz

Chargé de recherche CNRS

Laboratoire de Chimie Quantique de Strasbourg

Université
de Strasbourg



$\langle LCQ | S \rangle$
Laboratoire de Chimie Quantique de Strasbourg



Summary

- I) From quantum computing to chemistry
- II) Electronic structure on a Quantum Computer
- III) Near Term Era: VQE
- IV) Fault Tolerant Era: QPE

I) From quantum computing to quantum chemistry

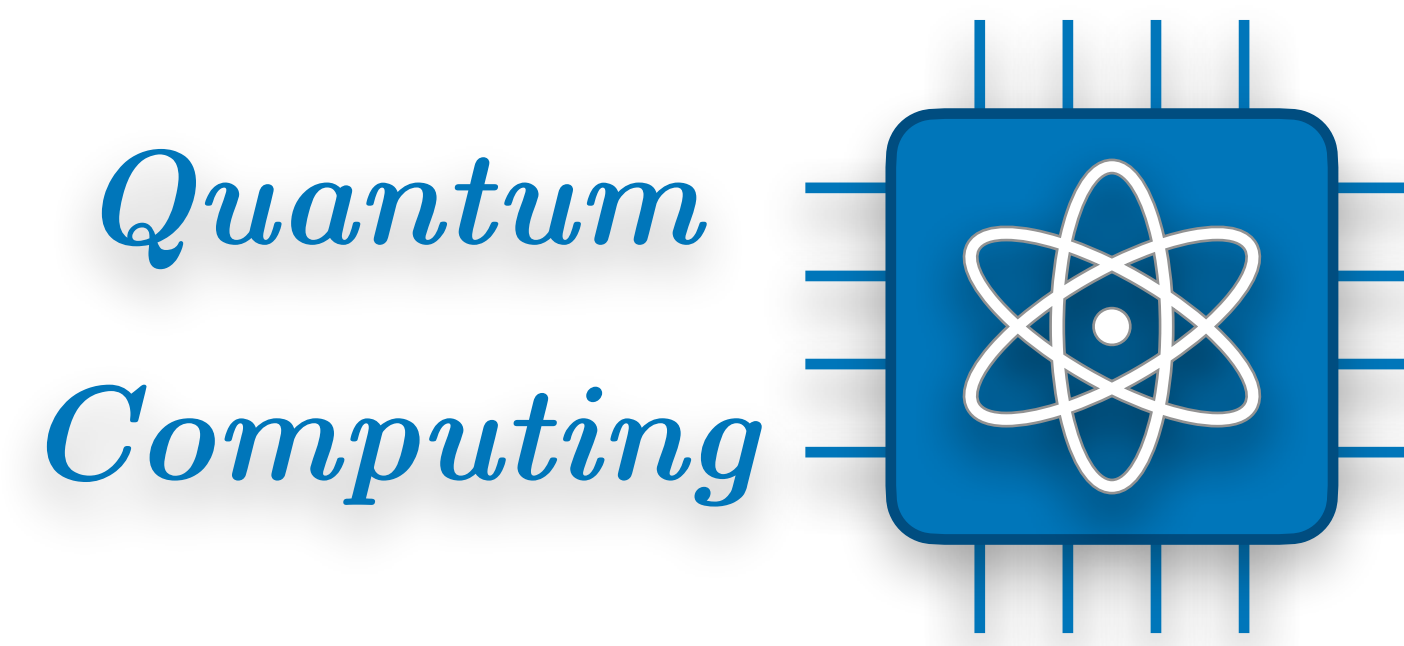

I) From quantum computing to quantum chemistry

Machine Learning

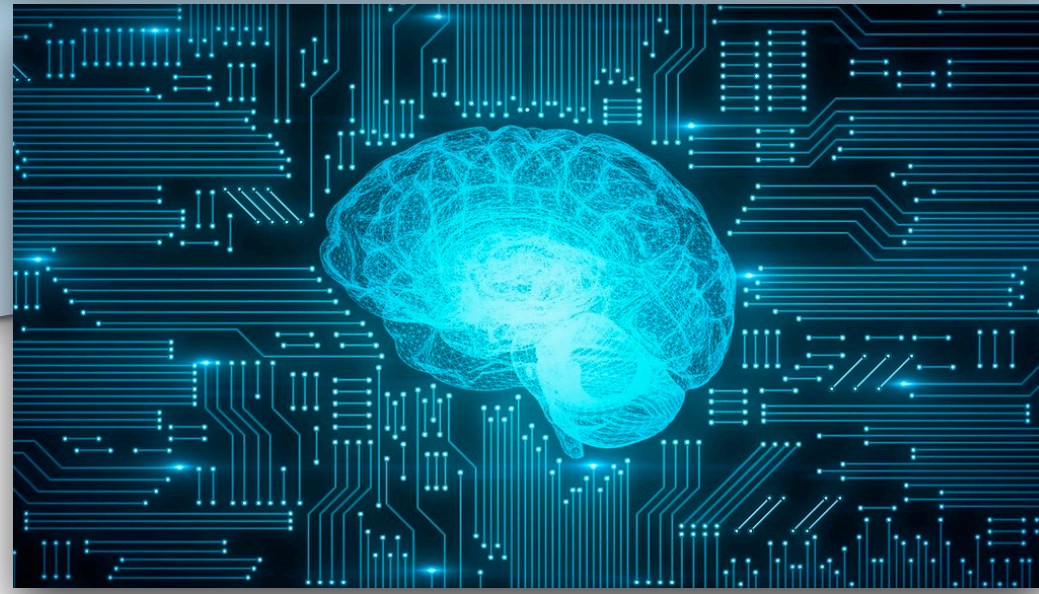

*Quantum
Computing*

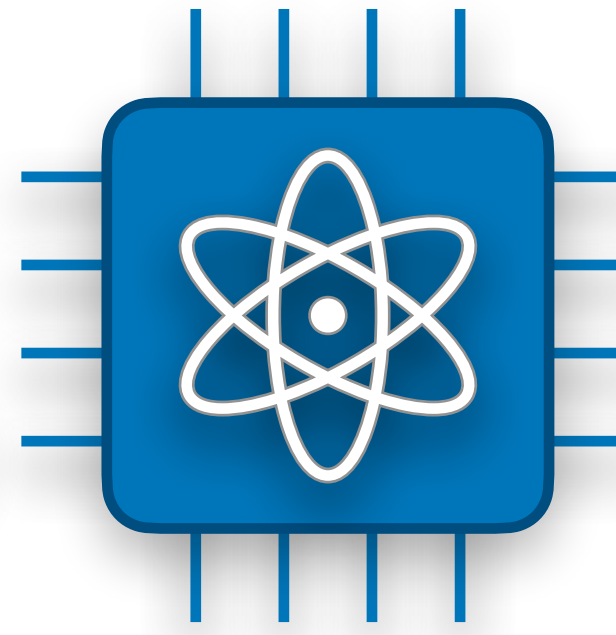

I) From quantum computing to quantum chemistry

Big Data

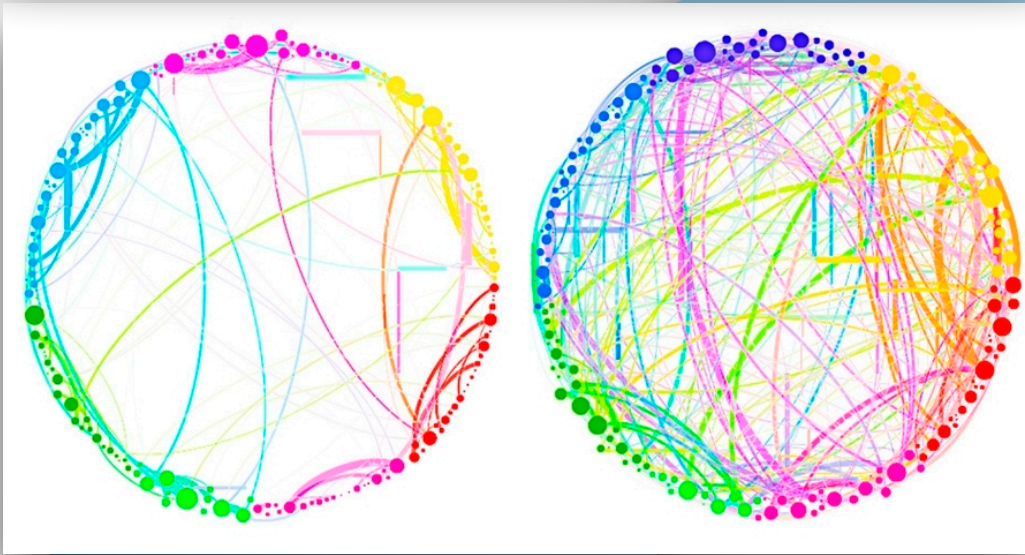

Machine Learning

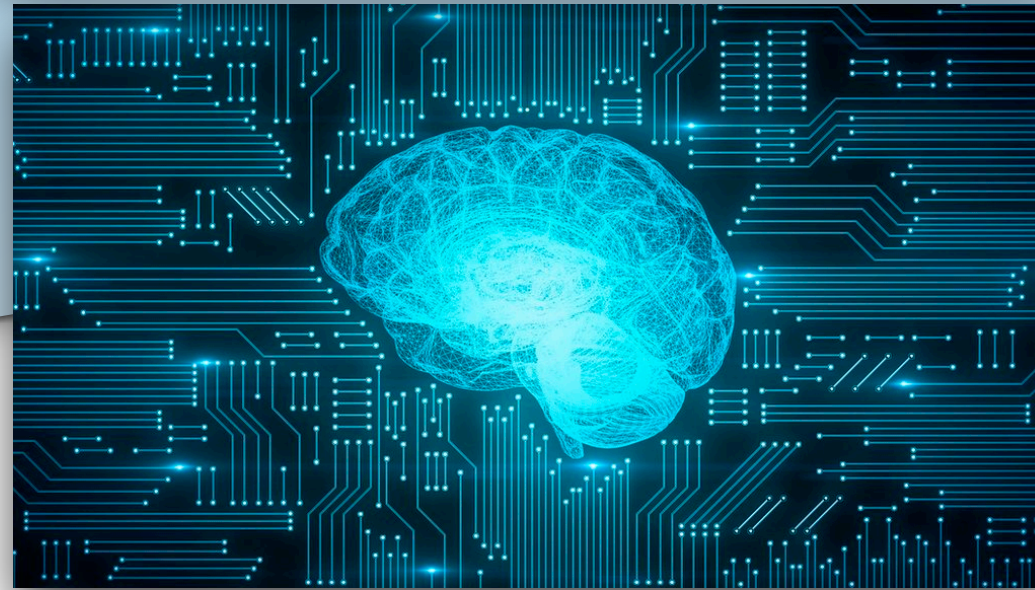

*Quantum
Computing*

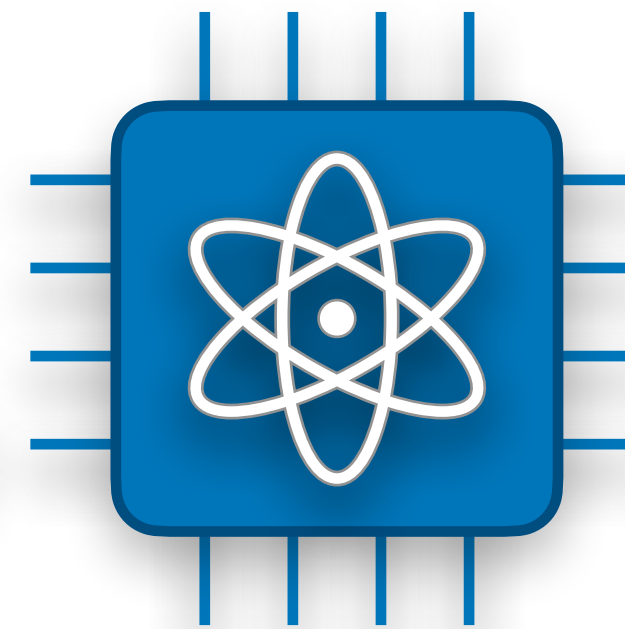

I) From quantum computing to quantum chemistry

Machine Learning

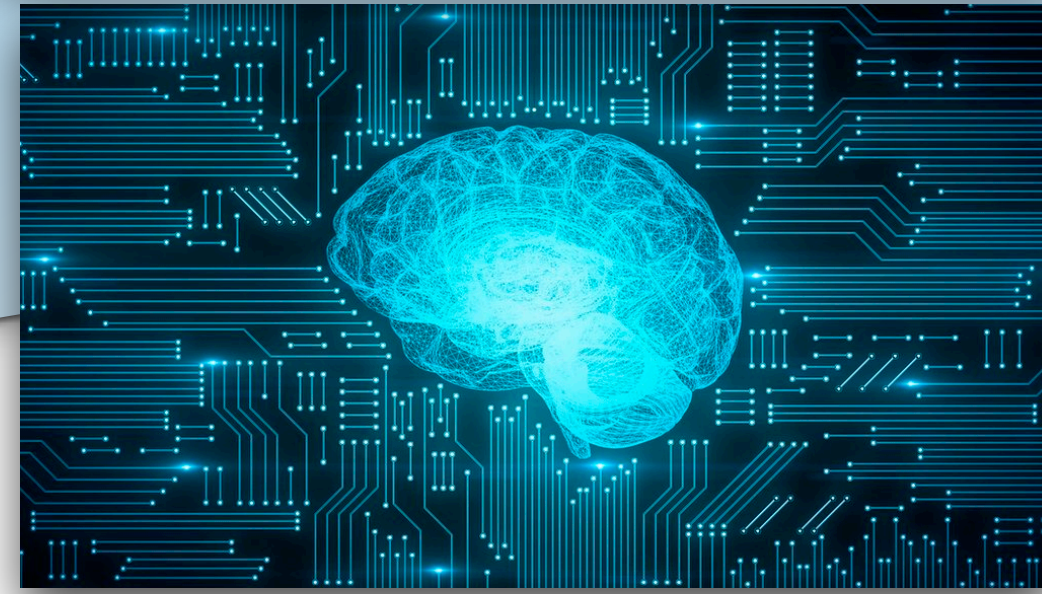

Big Data

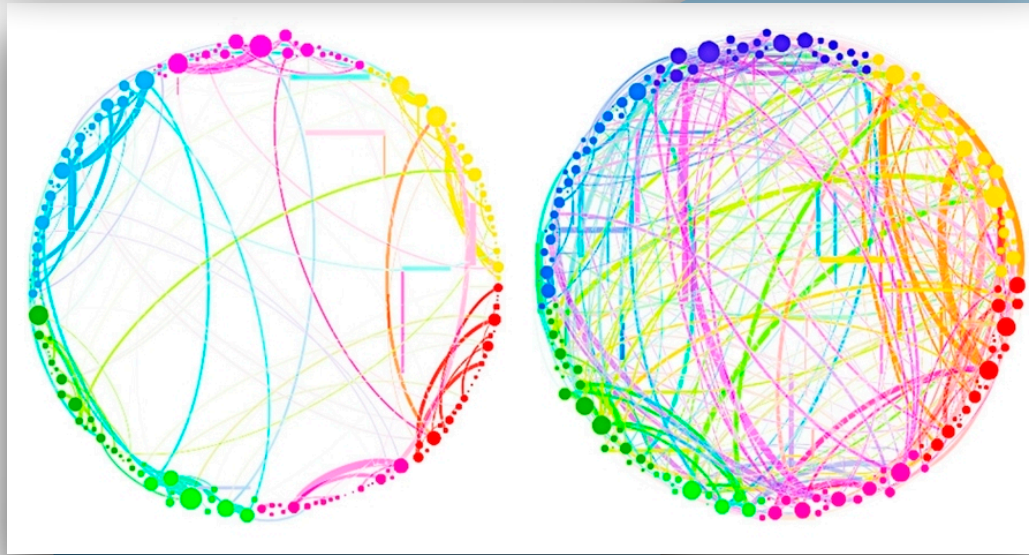

*Quantum
Computing*

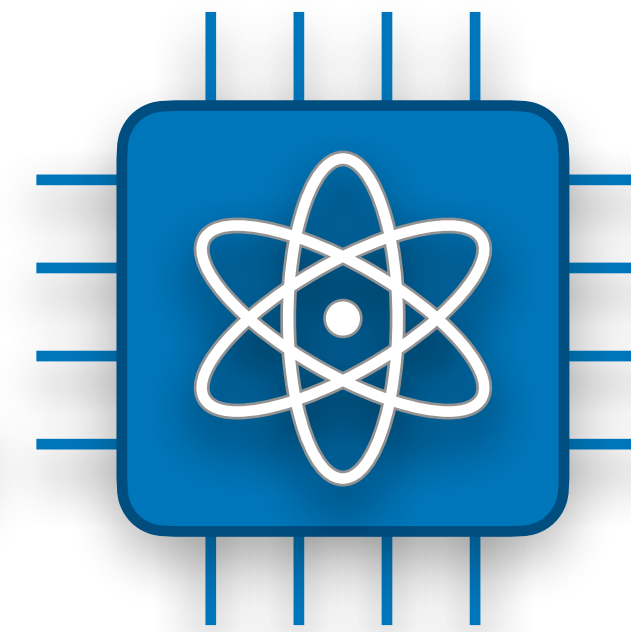

Cryptography



I) From quantum computing to quantum chemistry

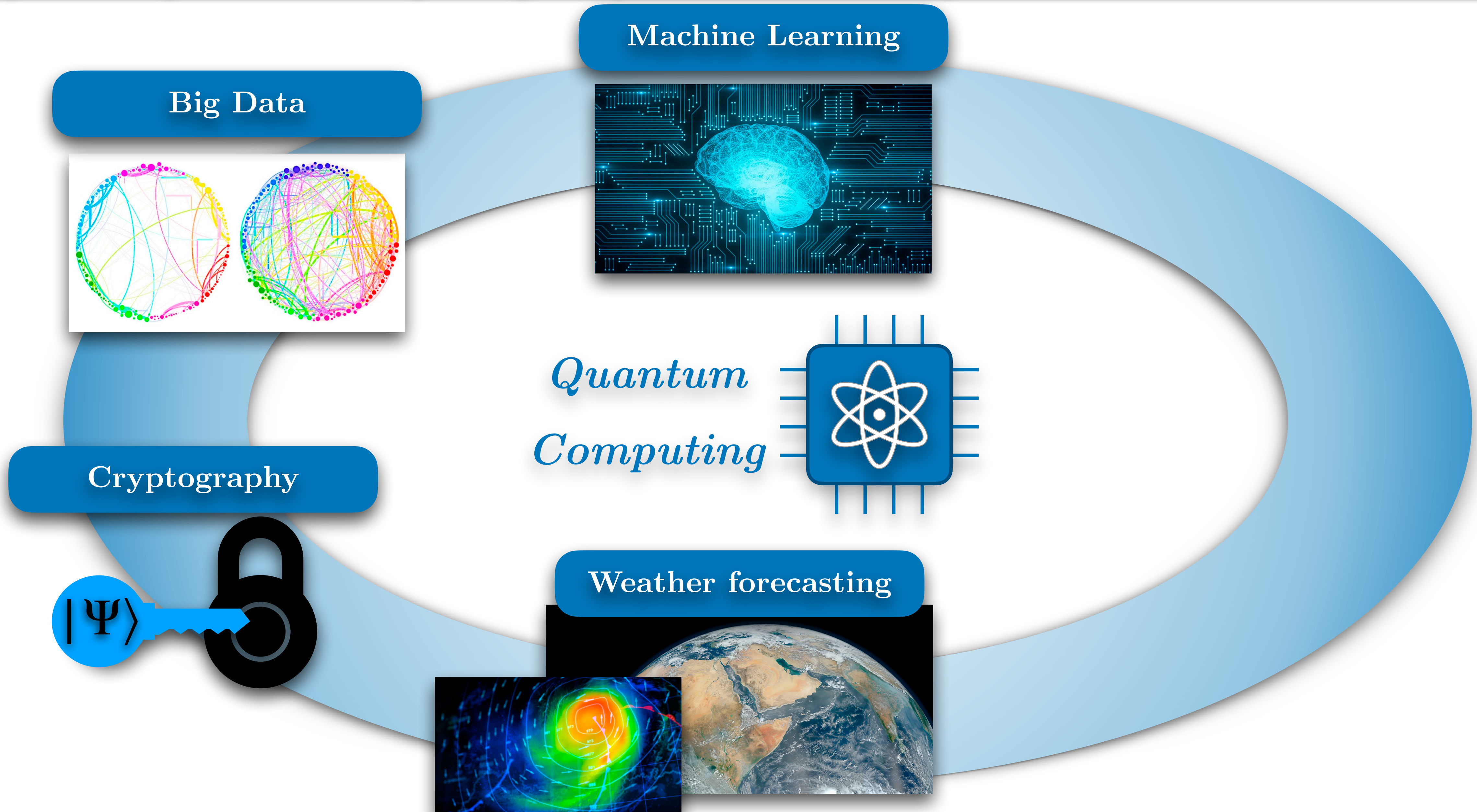

Big Data

Machine Learning

Quantum
Computing

Cryptography

Weather forecasting

$|\Psi\rangle$

I) From quantum computing to quantum chemistry

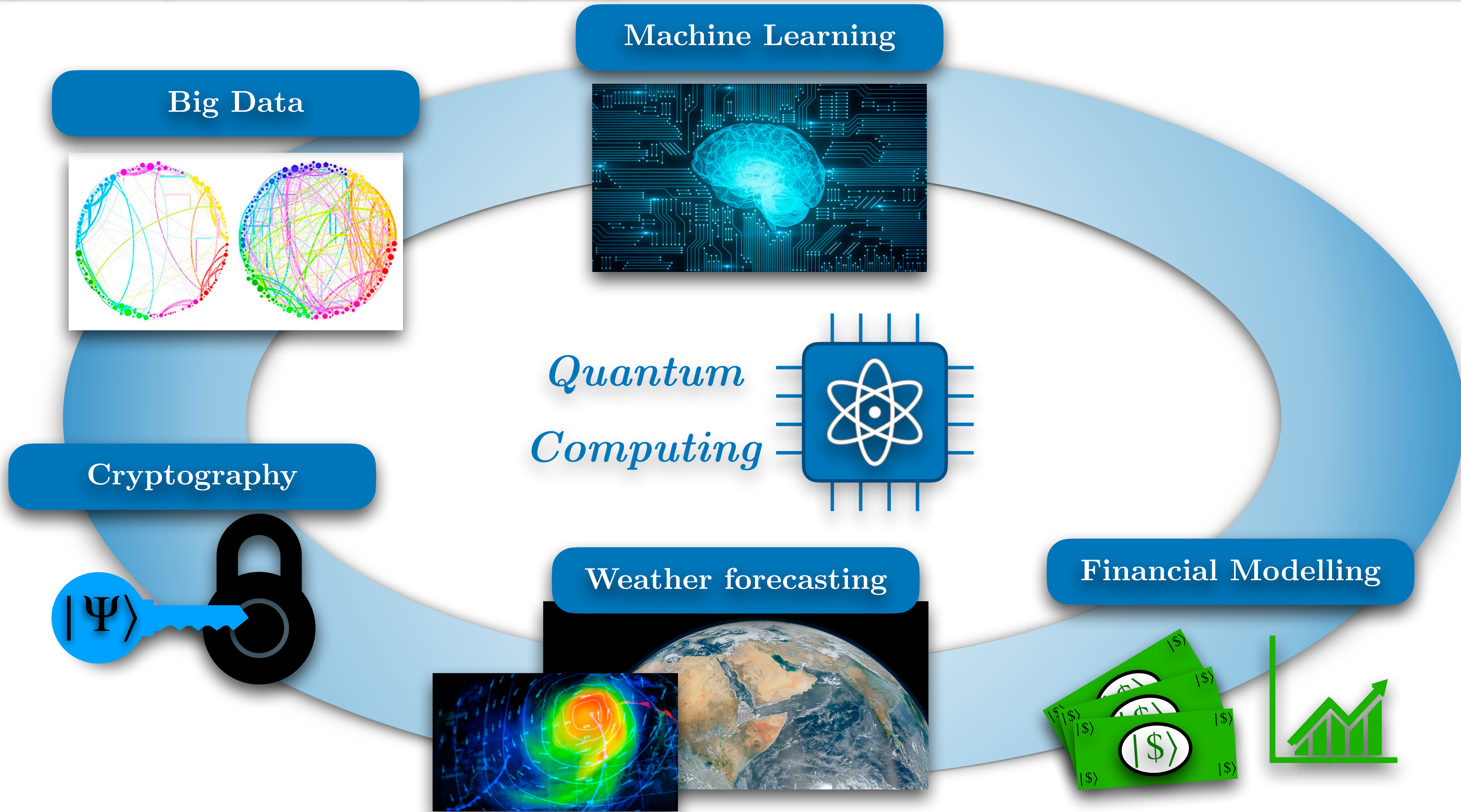

Big Data

Machine Learning

Quantum
Computing

Cryptography

Weather forecasting

Financial Modelling

$|\Psi\rangle$

$|\$ \rangle$

I) From quantum computing to quantum chemistry

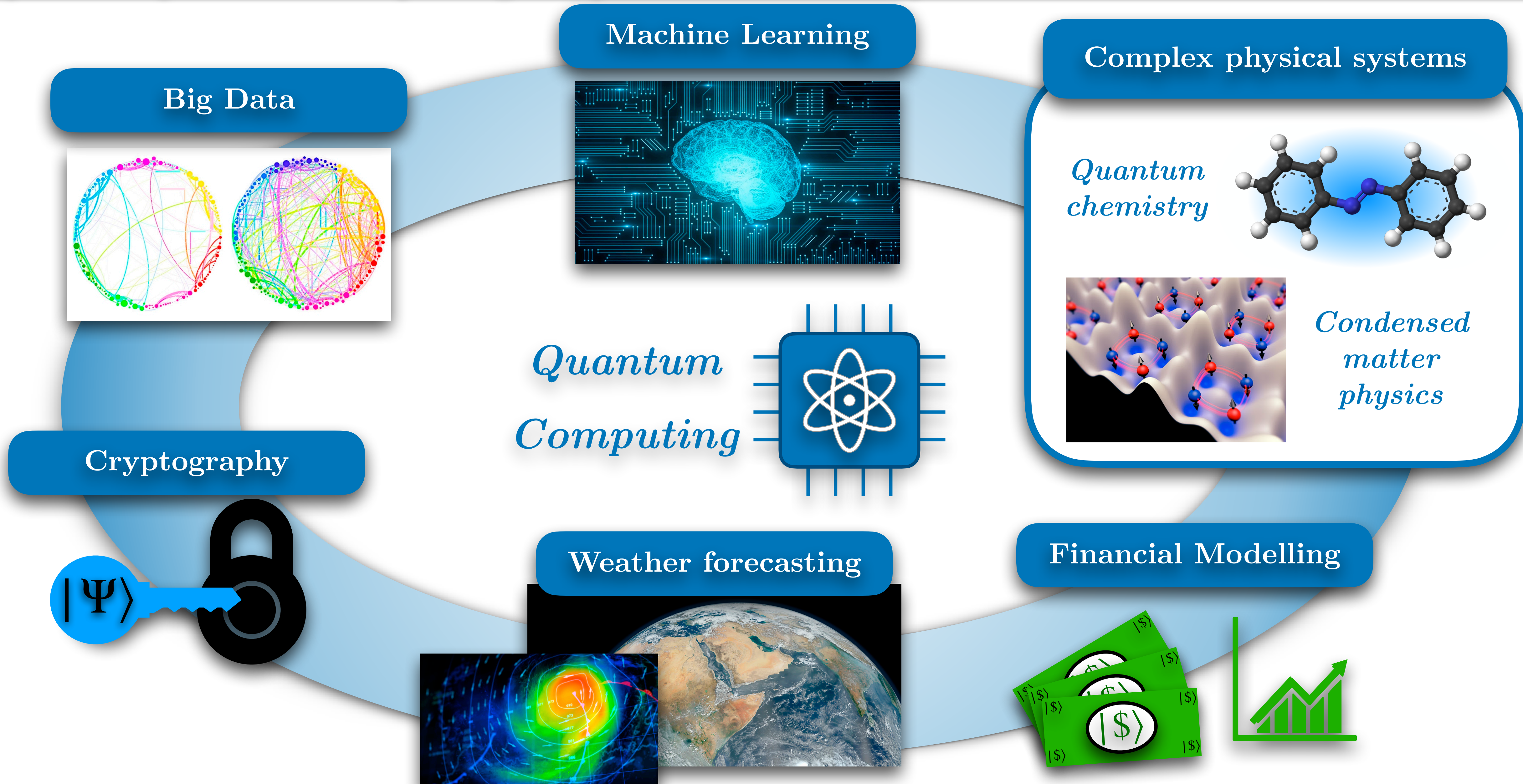

I) From quantum computing to quantum chemistry

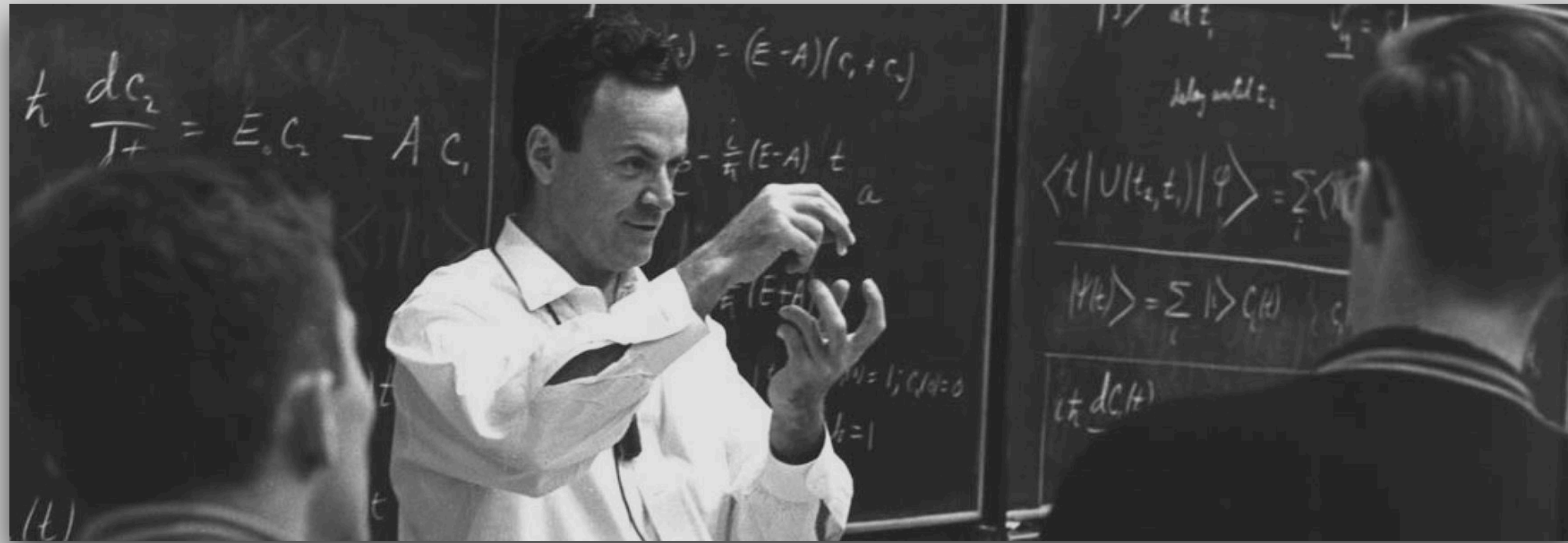

-Richard P. Feynman

“Nature (e.g. atoms, molecules ...) isn't classical and if you want to make a simulation of nature, you'd better make it quantum mechanical.”

I) From quantum computing to quantum chemistry

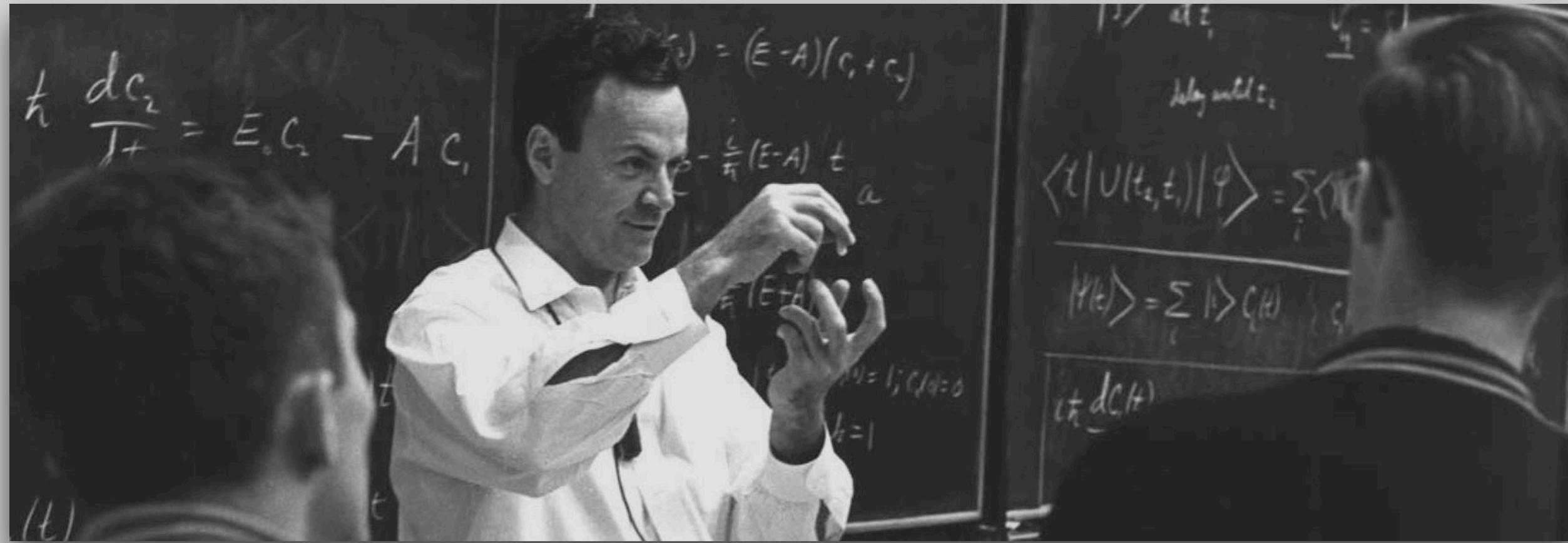

-Richard P. Feynman

“Nature (e.g. atoms, molecules ...) isn't classical and if you want to make a simulation of nature, you'd better make it quantum mechanical.”

Quantum Chemistry

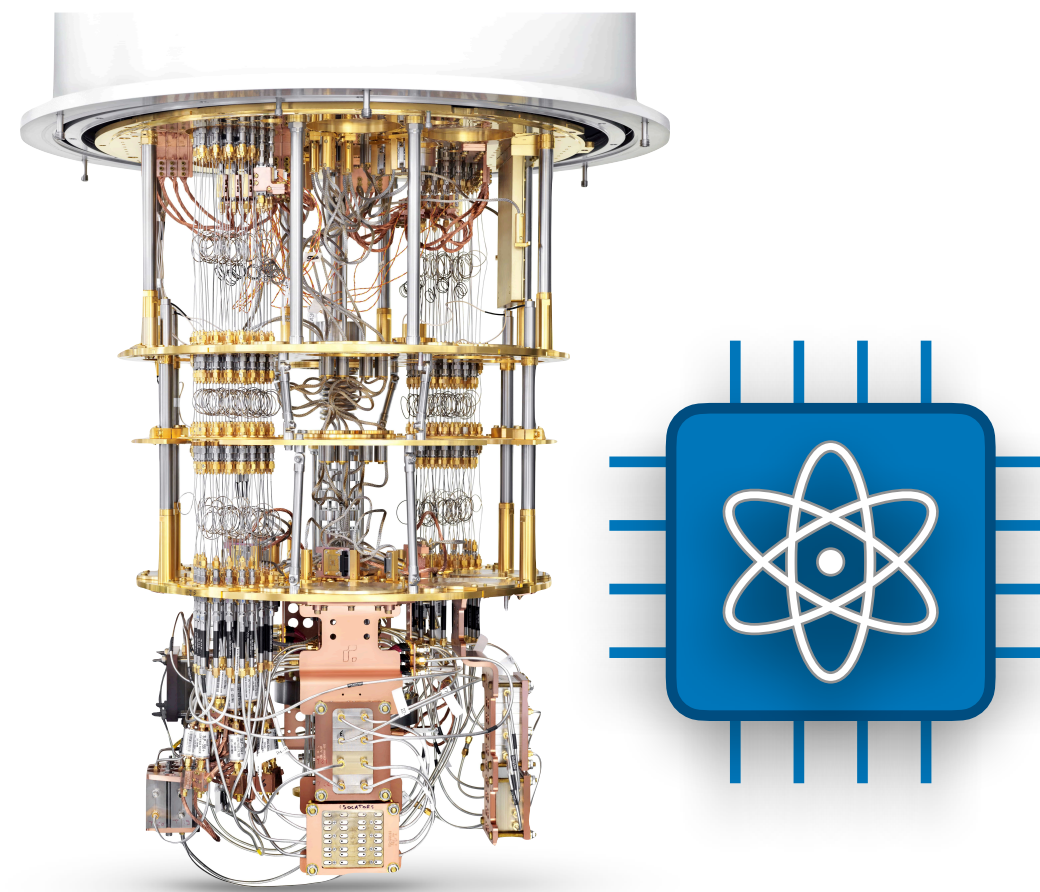
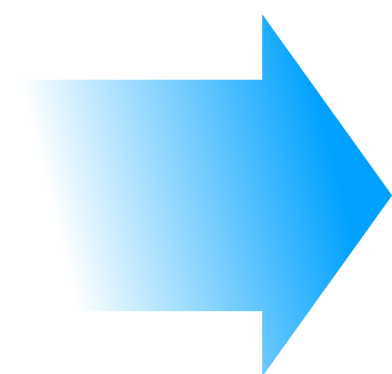
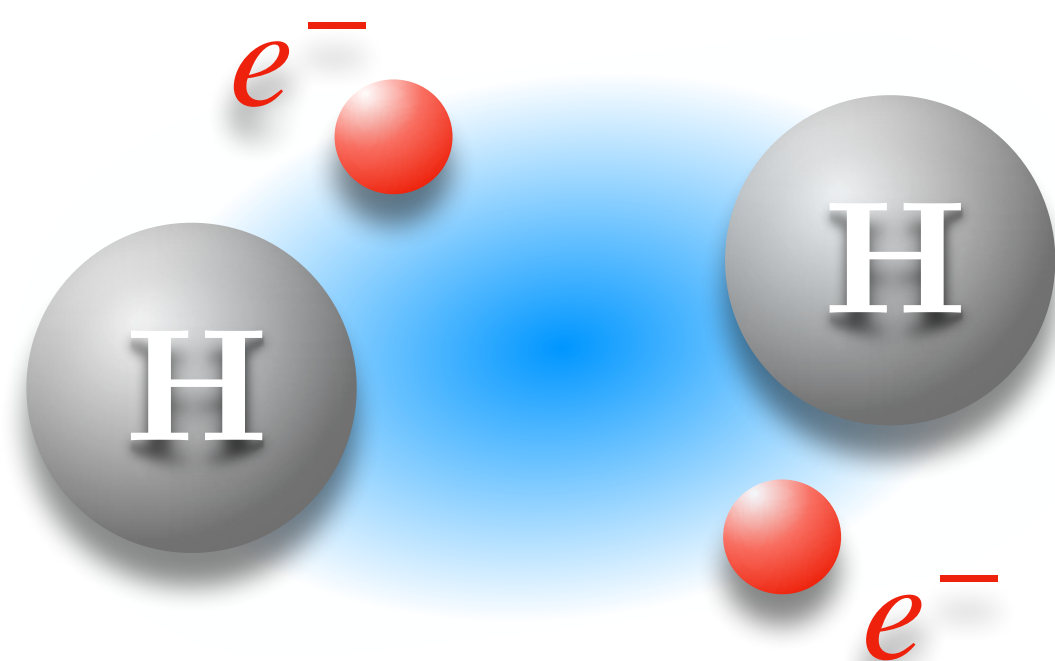

Quantum Computer

I) From quantum computing to quantum chemistry

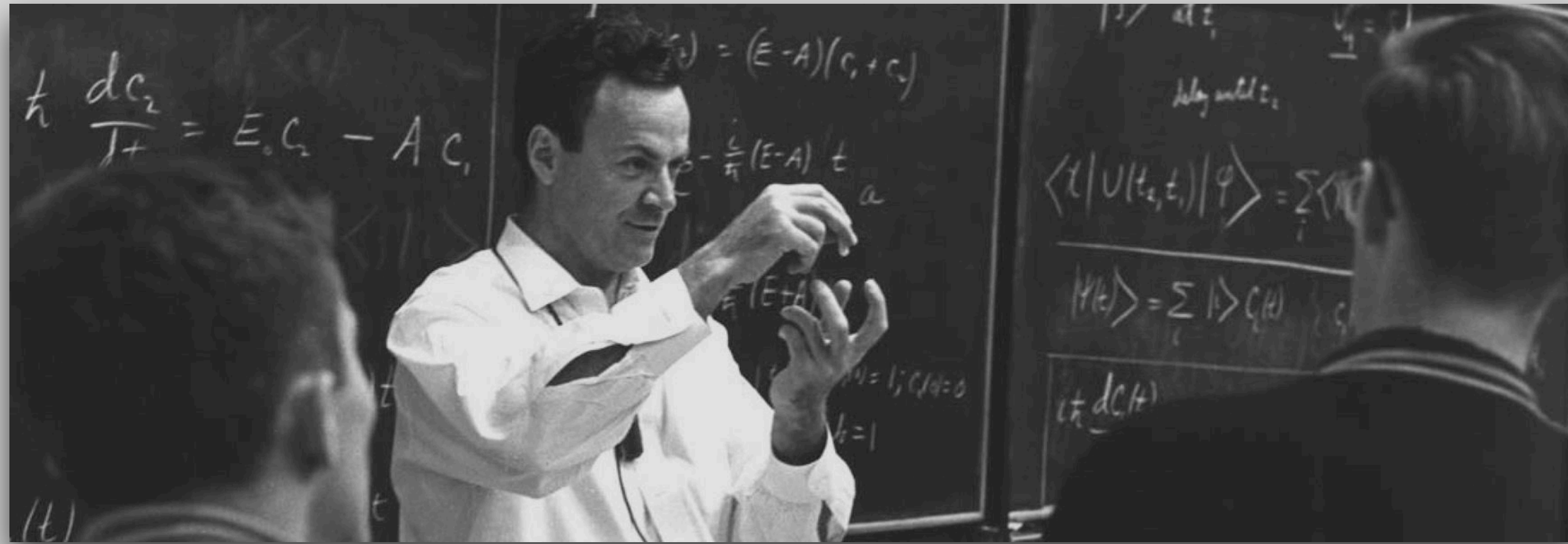

-Richard P. Feynman

“Nature (e.g. atoms, molecules ...) isn't classical and if you want to make a simulation of nature, you'd better make it quantum mechanical.”

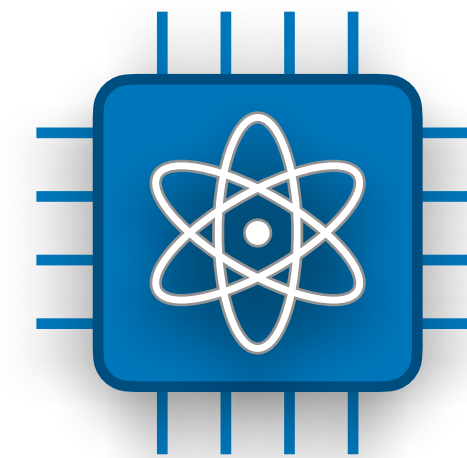
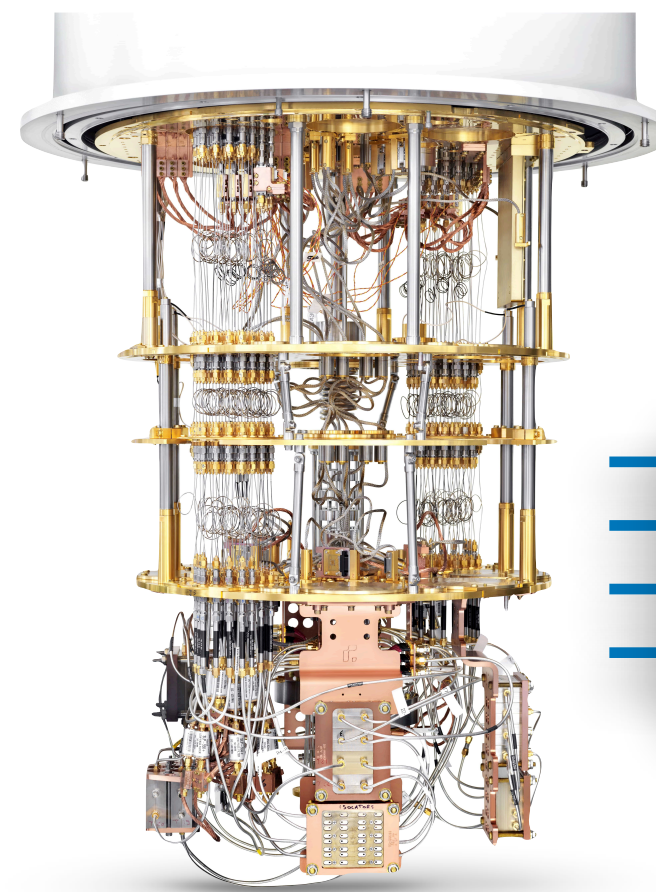
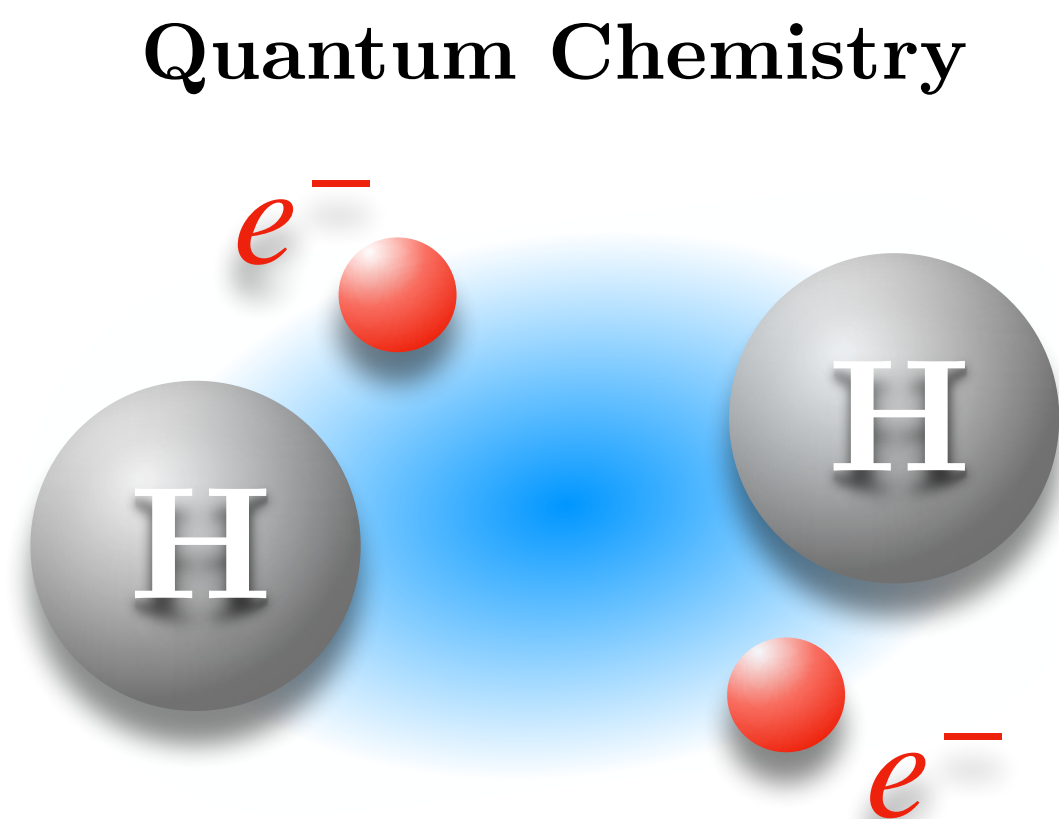

Quantum Computer

VS.



Classical Computer

I) From quantum computing to quantum chemistry

Classical Computer



Quantum Computer

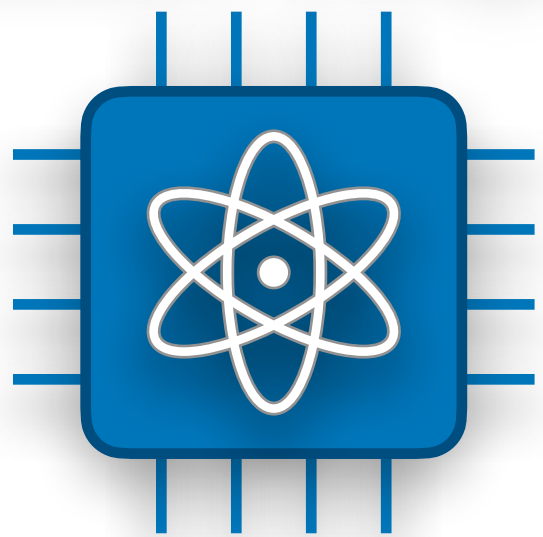

I) From quantum computing to quantum chemistry

Unit of Information

Basic Logic

Prog. Language

Classical Computer



VS.

Quantum Computer

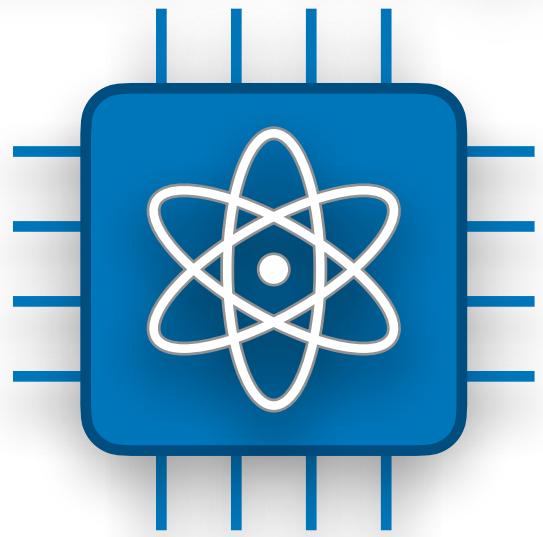

I) From quantum computing to quantum chemistry

Unit of Information

Basic Logic

Prog. Language

Classical Computer



The Bit

0
1

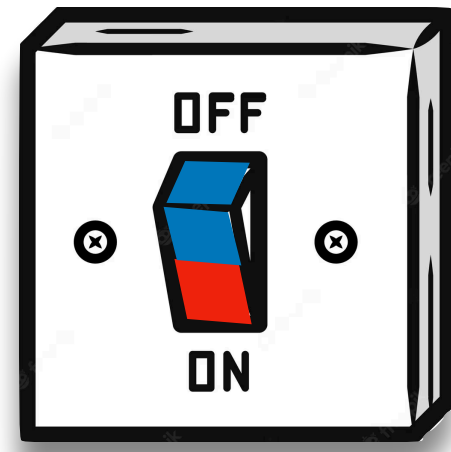

VS.

Quantum Computer

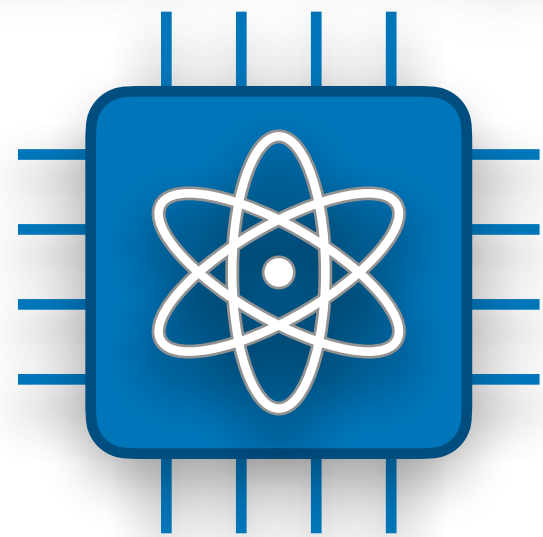

I) From quantum computing to quantum chemistry

Unit of Information

Basic Logic

Prog. Langage

Classical Computer



The Bit

0
1

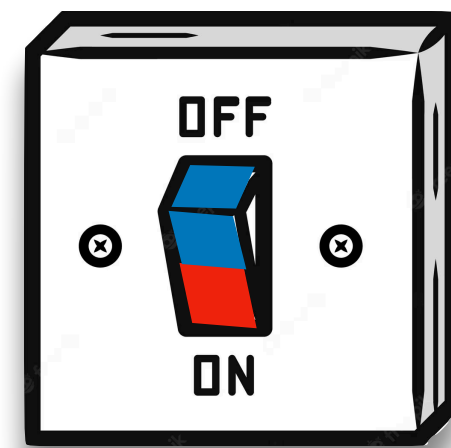

Logical circuit

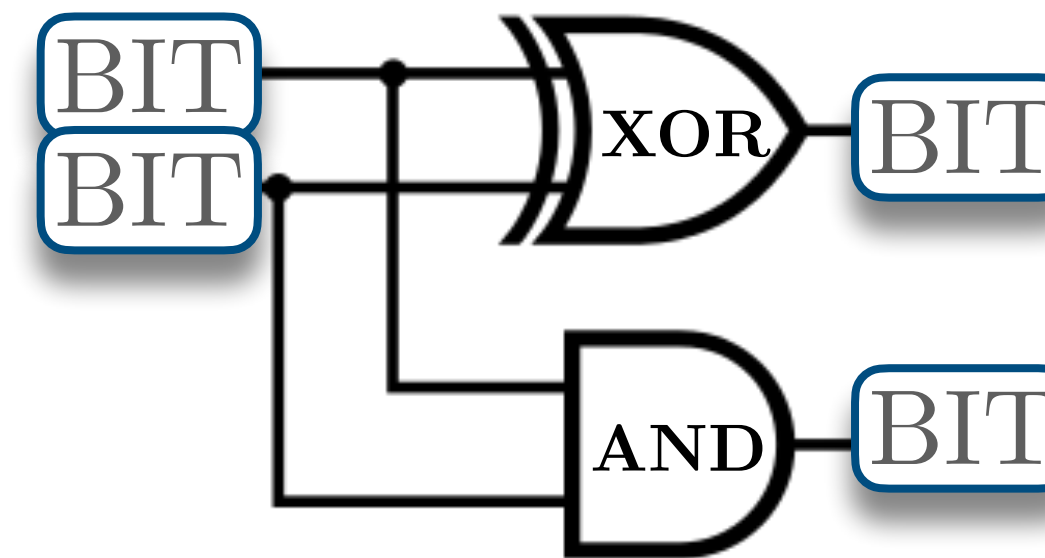

VS.

Quantum Computer

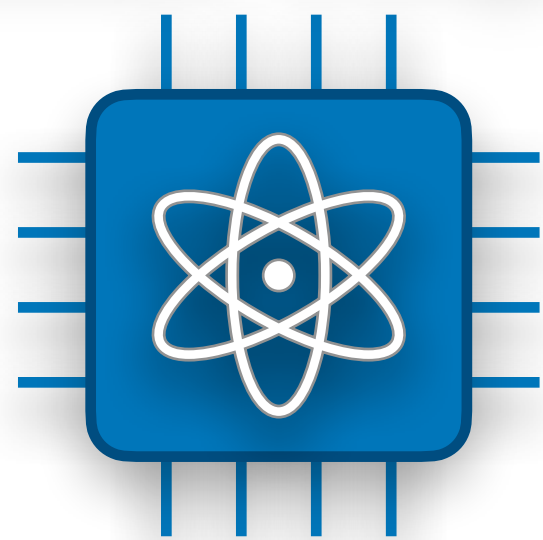

I) From quantum computing to quantum chemistry

Unit of Information

Basic Logic

Prog. Language

Classical Computer



The Bit

0
1

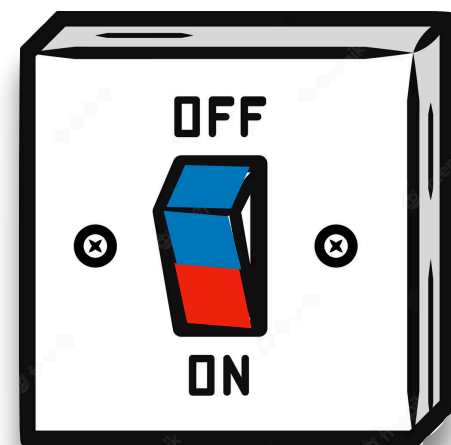

Logical circuit

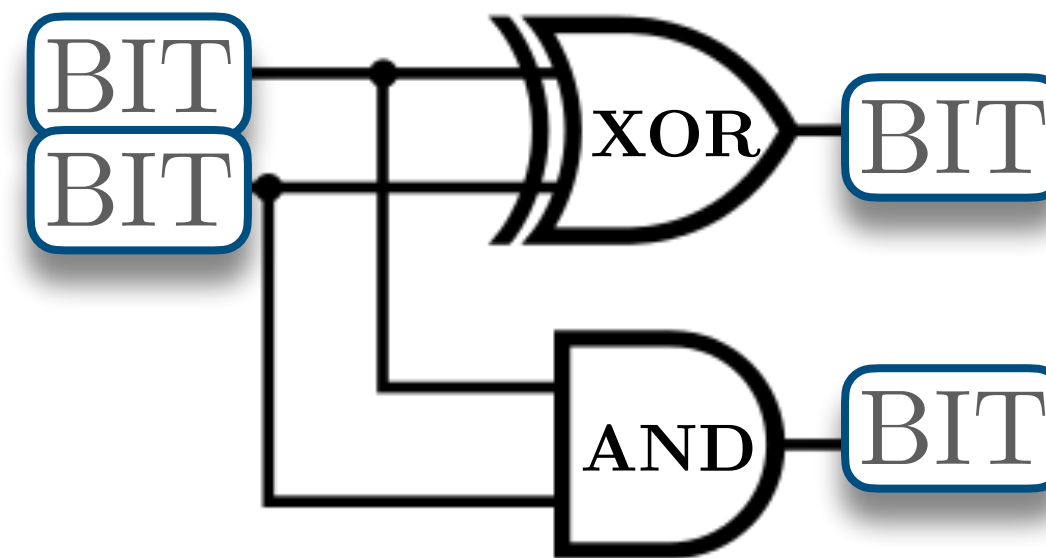

Fortran, C, Python ...



VS.

Quantum Computer

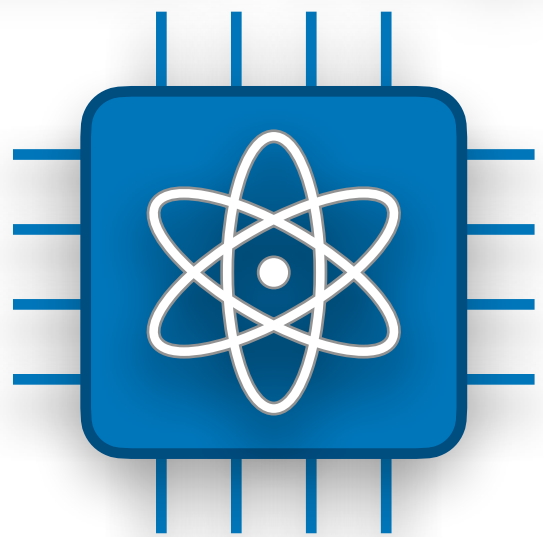

I) From quantum computing to quantum chemistry

Unit of Information

Basic Logic

Prog. Language

Classical Computer



The Bit

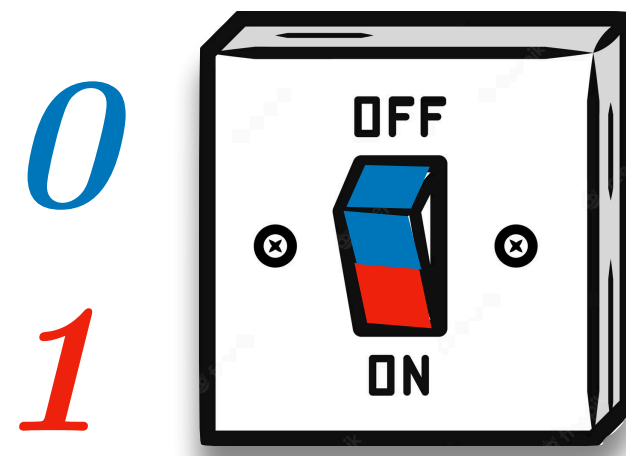

Logical circuit

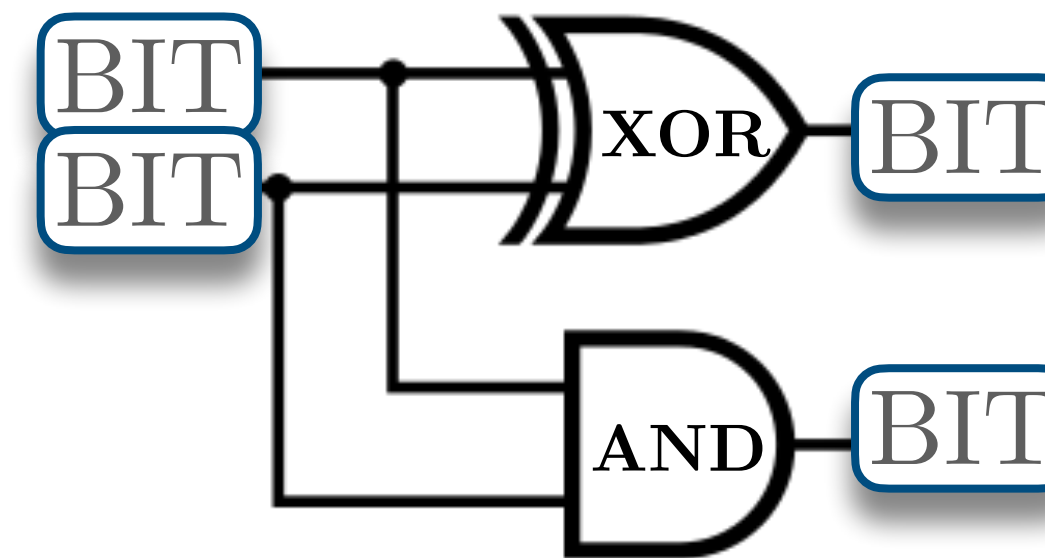

Fortran, C, Python ...



VS.

The Qubit

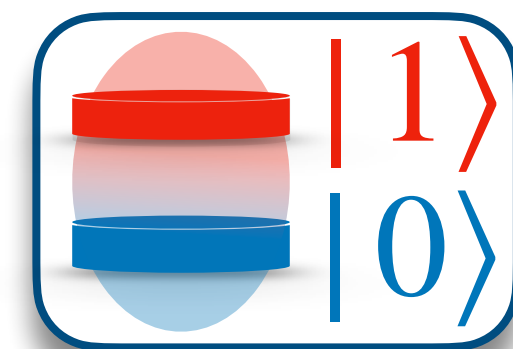

$$|Q\rangle = c_0 |0\rangle + c_1 |1\rangle$$

Quantum Computer

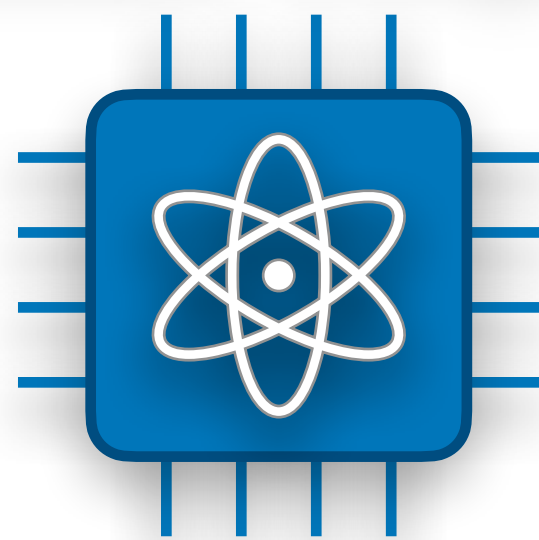

I) From quantum computing to quantum chemistry

Unit of Information

Basic Logic

Prog. Language

Classical Computer



The Bit

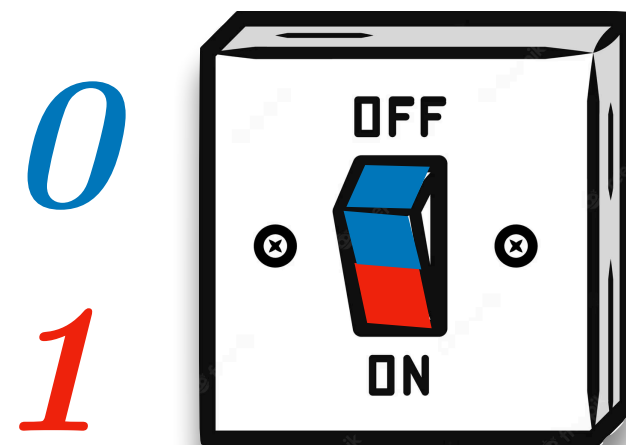

Logical circuit

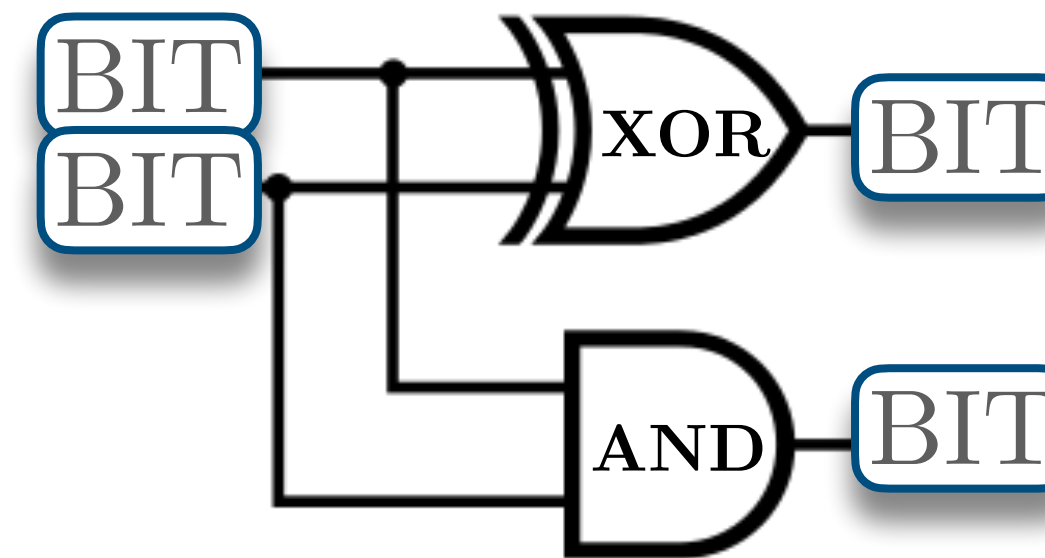

Fortran, C, Python ...



VS.

The Qubit

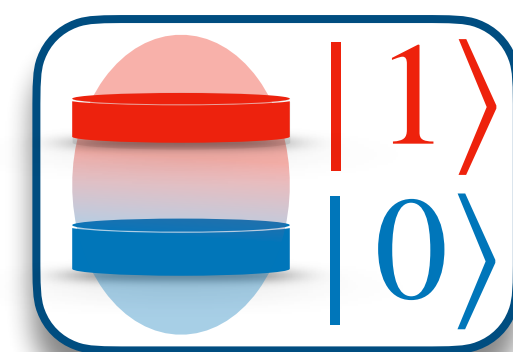

$$|Q\rangle = c_0 |0\rangle + c_1 |1\rangle$$

Quantum Circuit

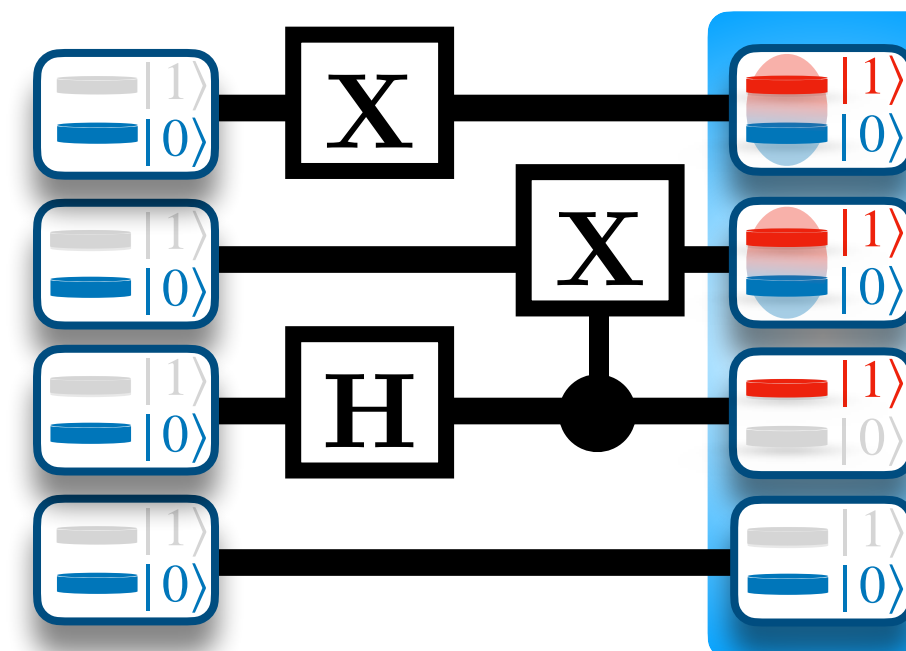

Quantum Computer

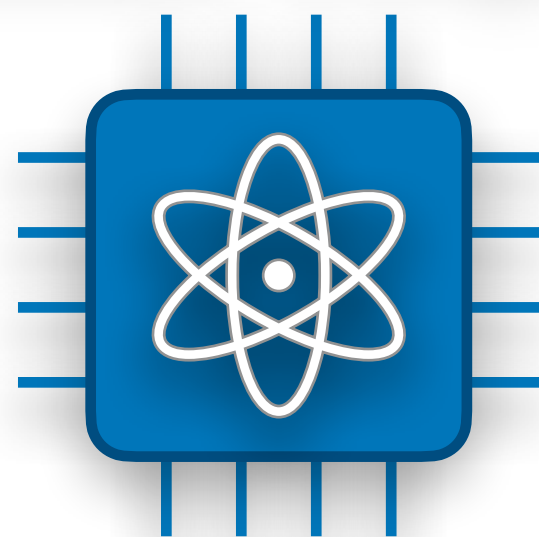

I) From quantum computing to quantum chemistry

Unit of Information

Basic Logic

Prog. Language

Classical Computer



The Bit

0
1

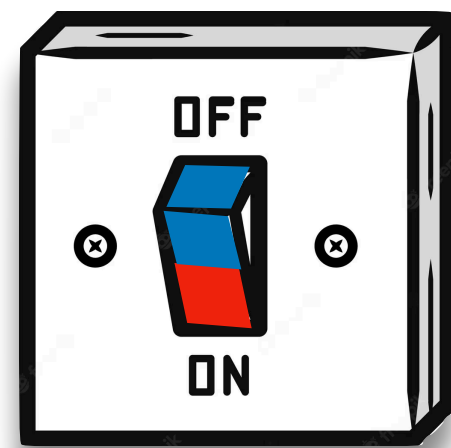

Logical circuit

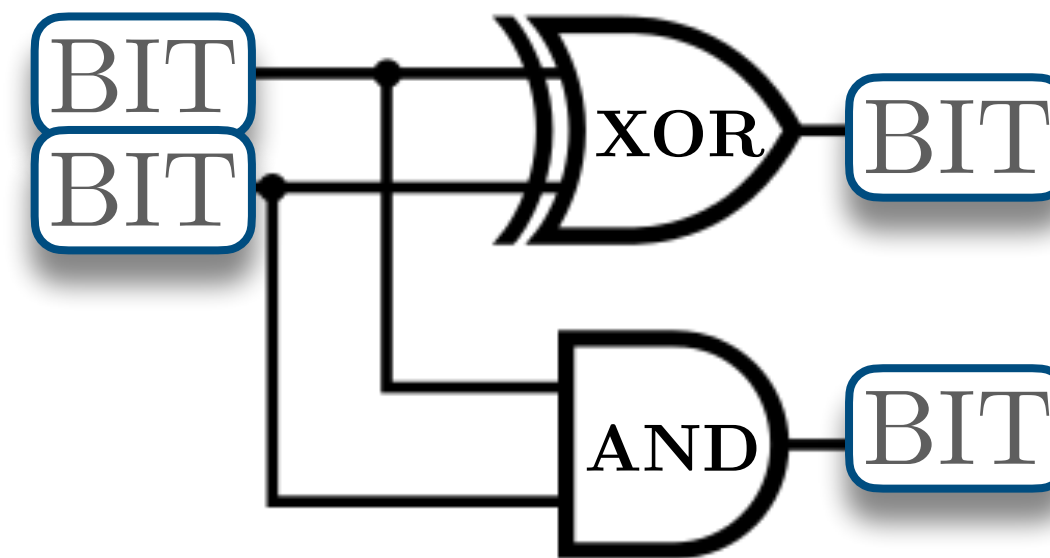

Fortran, C, Python ...



VS.

Quantum Computer

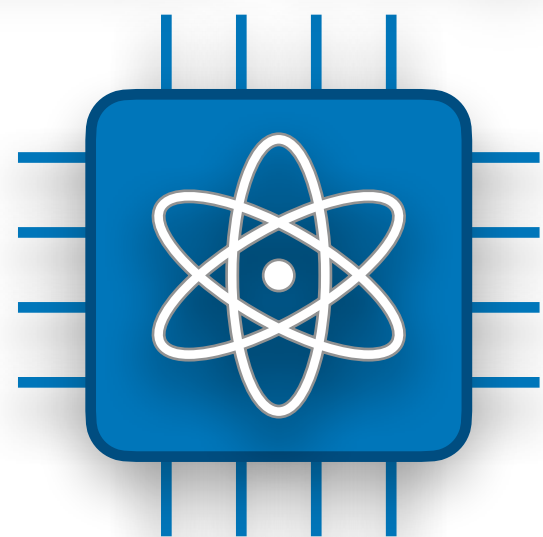

The Qubit

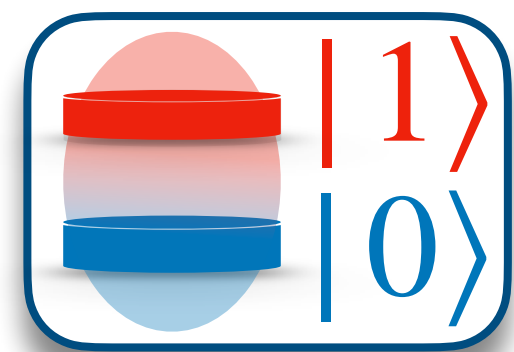

$$|Q\rangle = c_0 |0\rangle + c_1 |1\rangle$$

Quantum Circuit

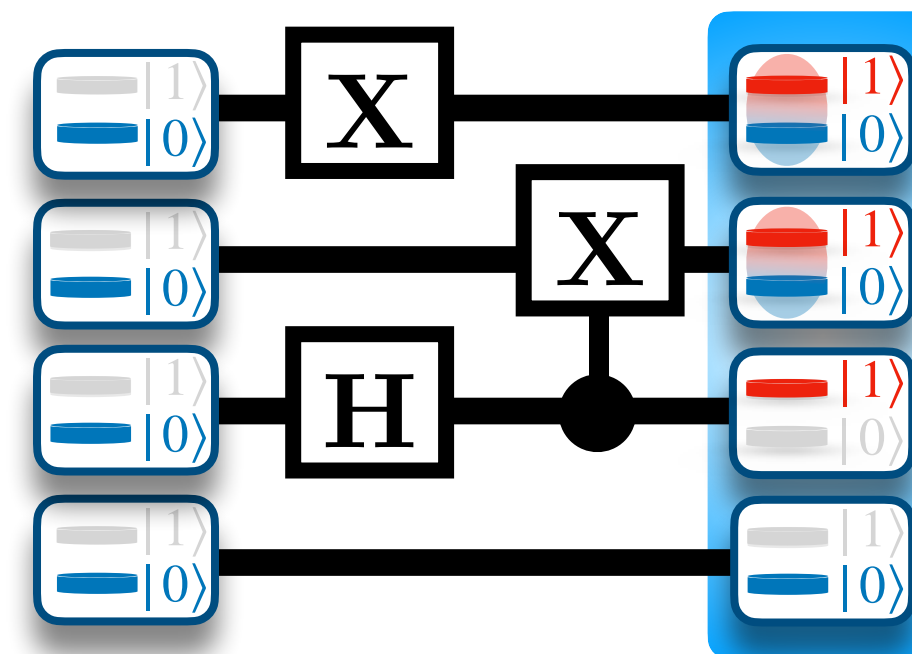

Quantum Physics !
(Unitary Transformations)

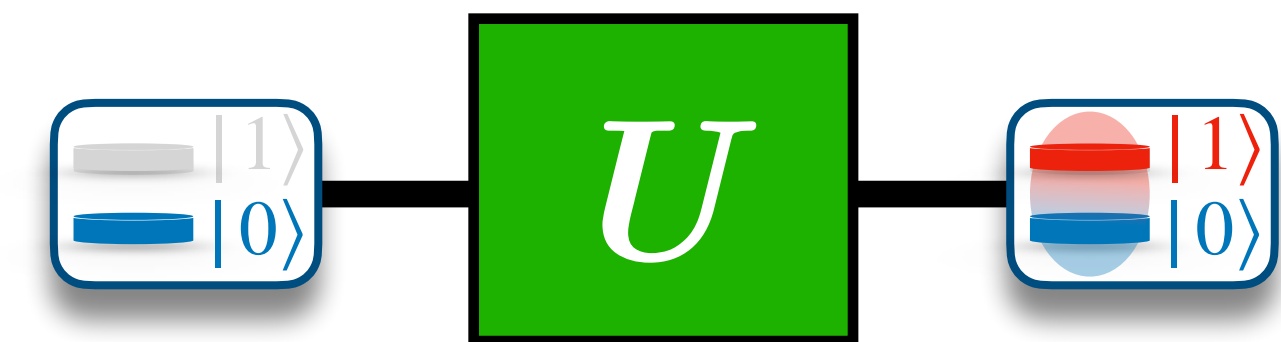

I) From quantum computing to quantum chemistry

Unit of Information

Basic Logic

Prog. Language

Classical Computer



The Bit

0
1

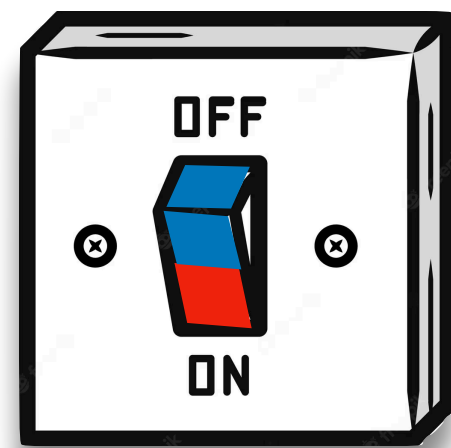

Logical circuit

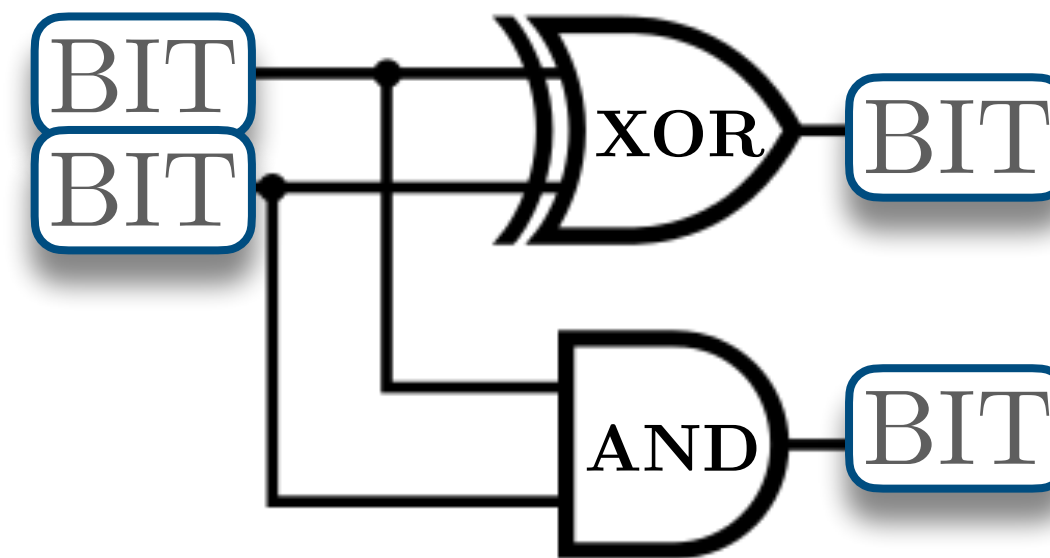

Fortran, C, Python ...



VS.

Quantum Computer

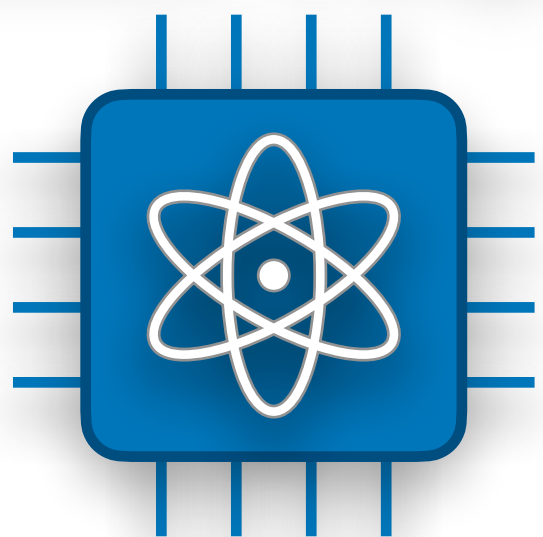

The Qubit

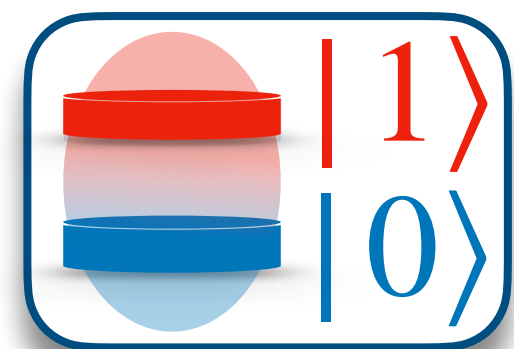

$$|Q\rangle = c_0 |0\rangle + c_1 |1\rangle$$

Quantum Circuit

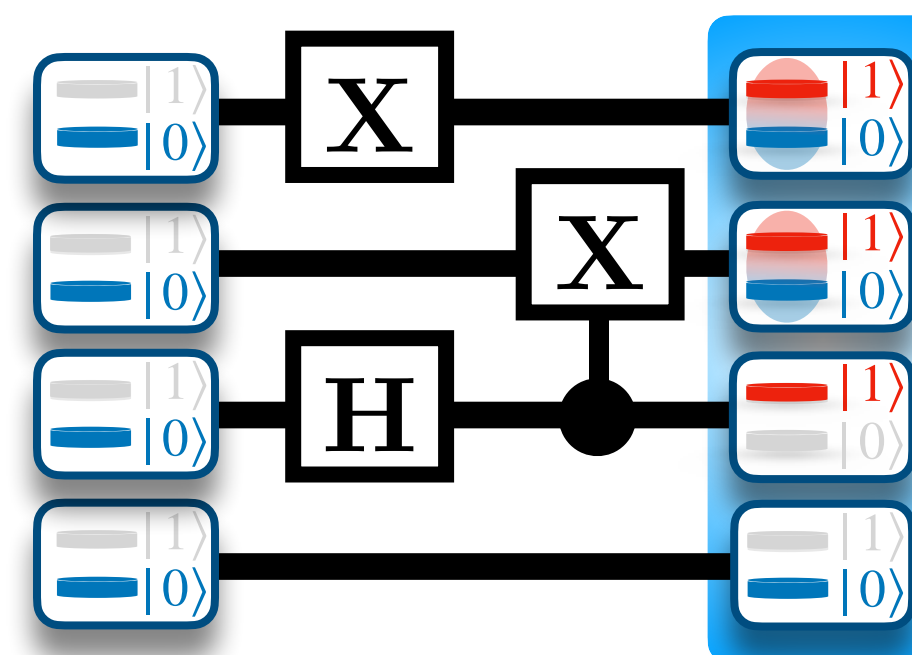

Quantum Physics !
(Unitary Transformations)

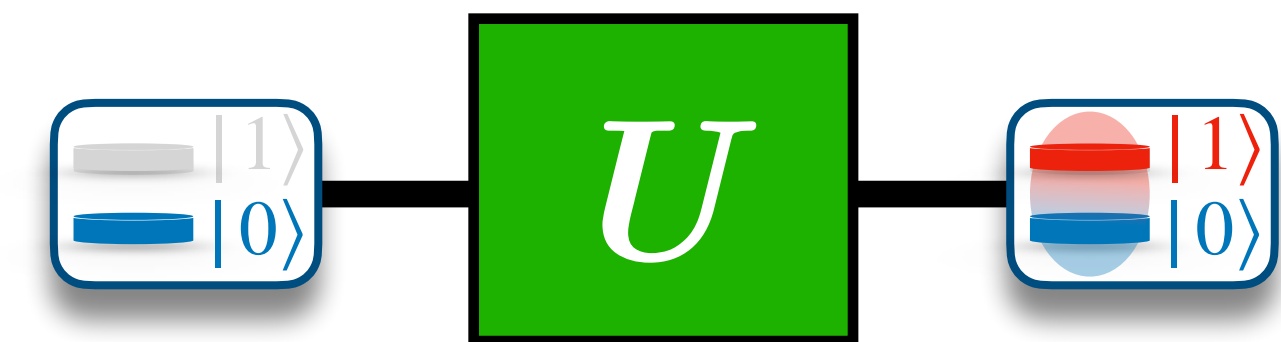

QUESTION

Why a Quantum computer is more powerful than a classical one ?

I) From quantum computing to quantum chemistry

ANSWER

How to encode/manipulate information in Qubits vs. Bits

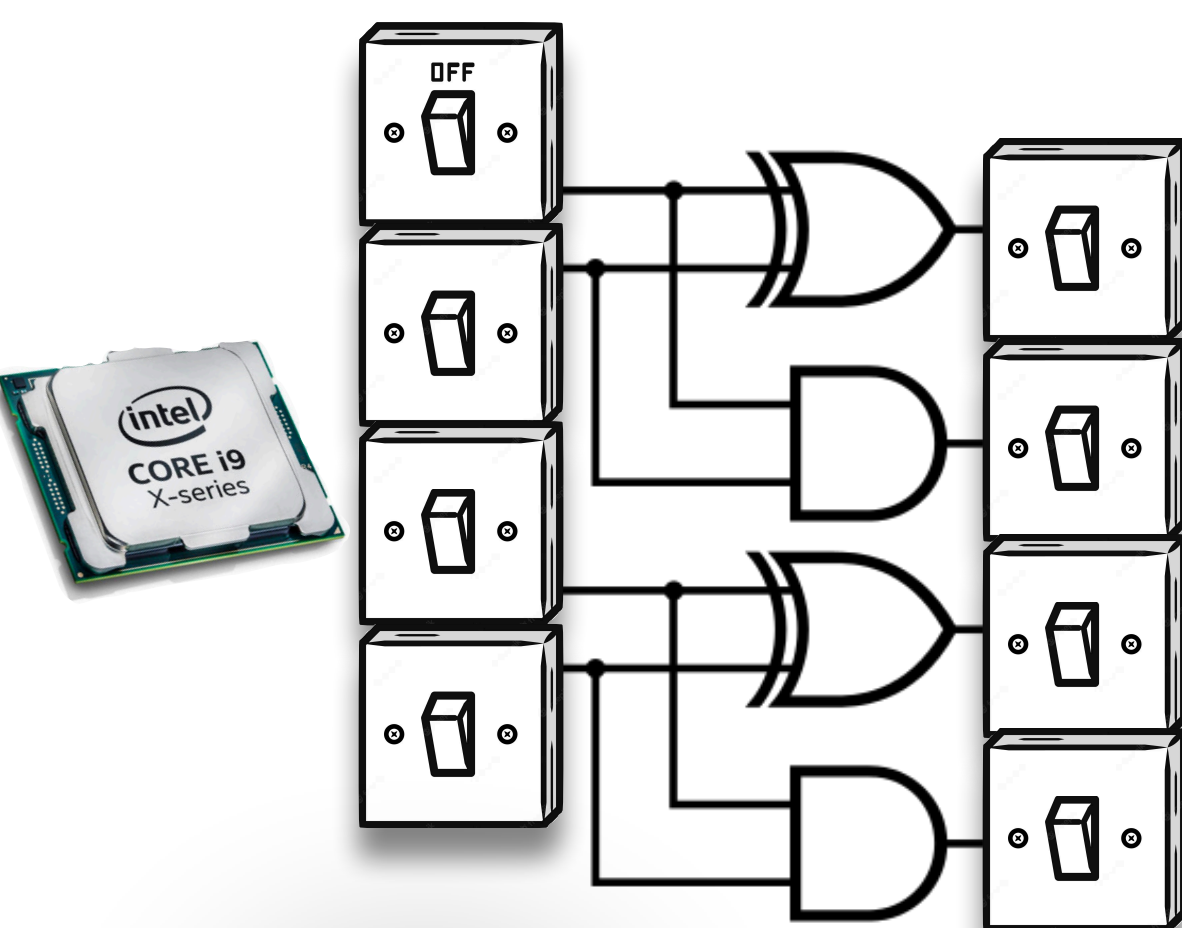

VS.

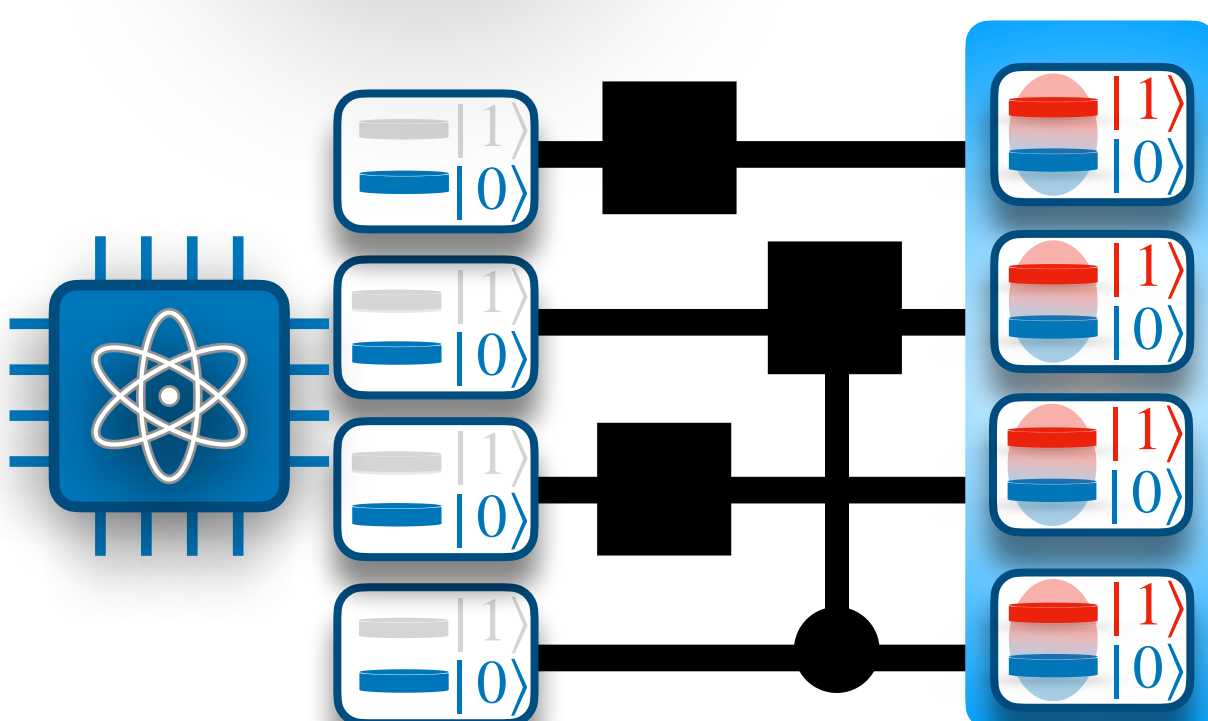

I) From quantum computing to quantum chemistry

ANSWER

How to encode/manipulate information in Qubits vs. Bits

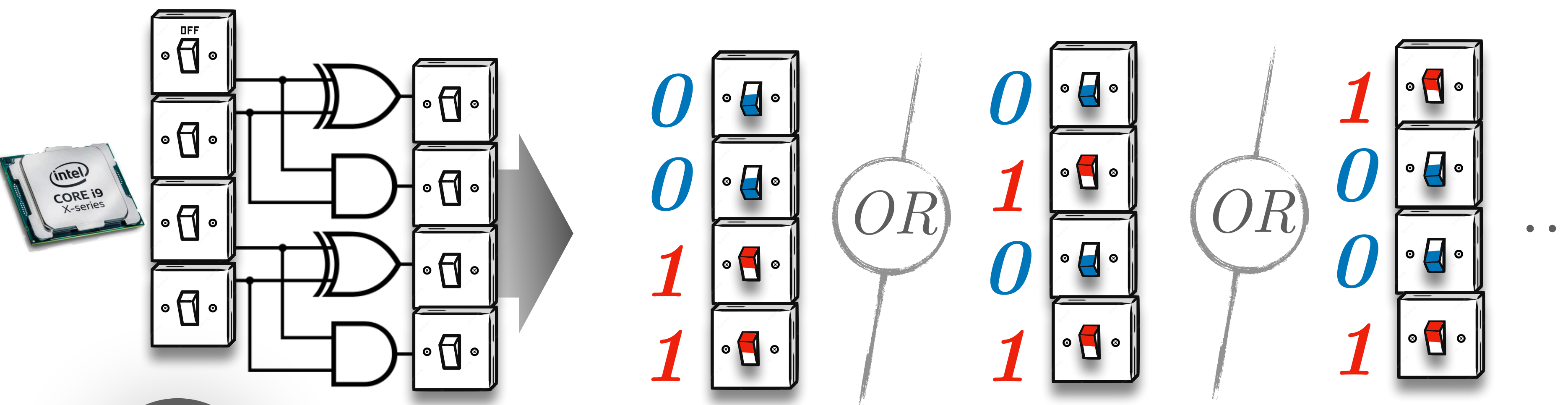

VS.

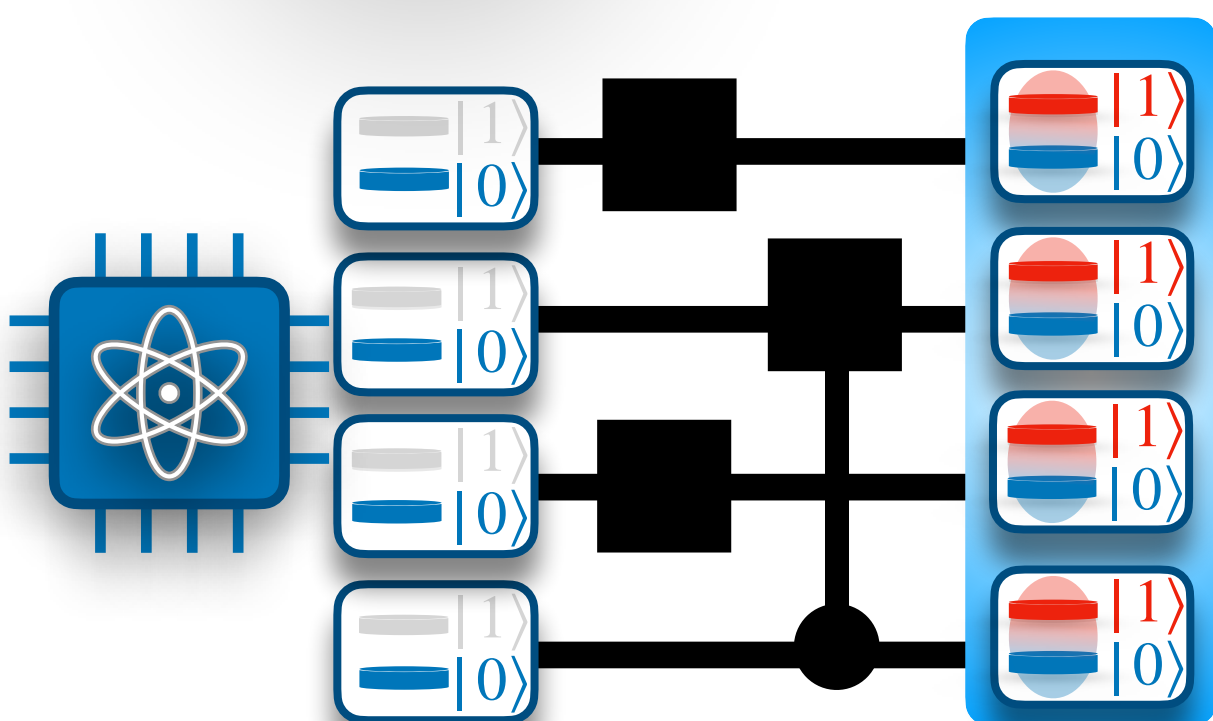

I) From quantum computing to quantum chemistry

ANSWER

How to encode/manipulate information in Qubits vs. Bits

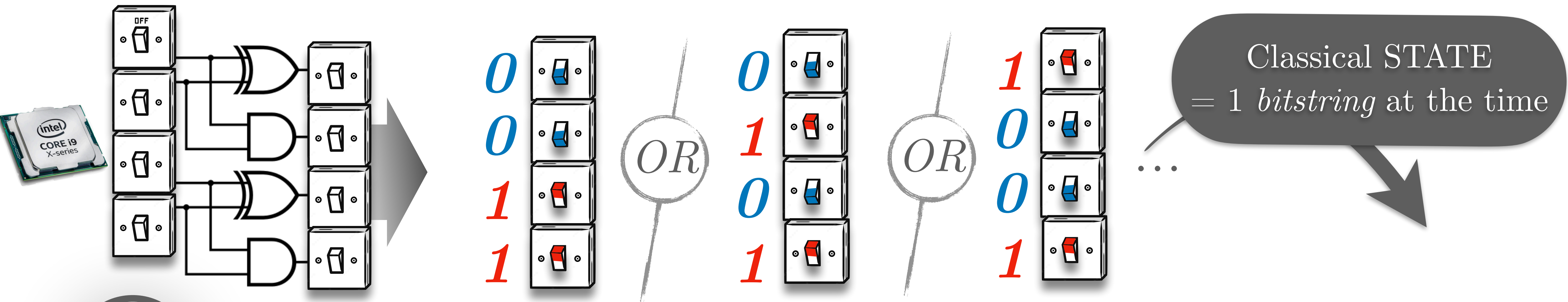

VS.

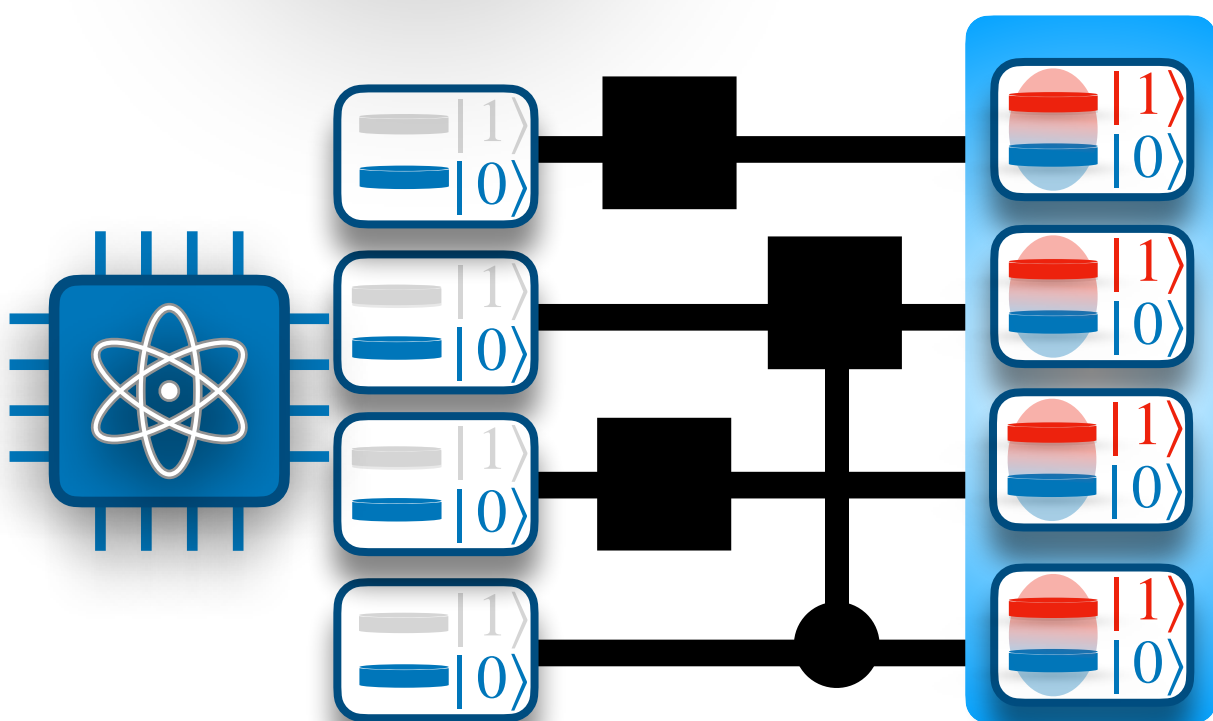

I) From quantum computing to quantum chemistry

ANSWER

How to encode/manipulate information in Qubits vs. Bits

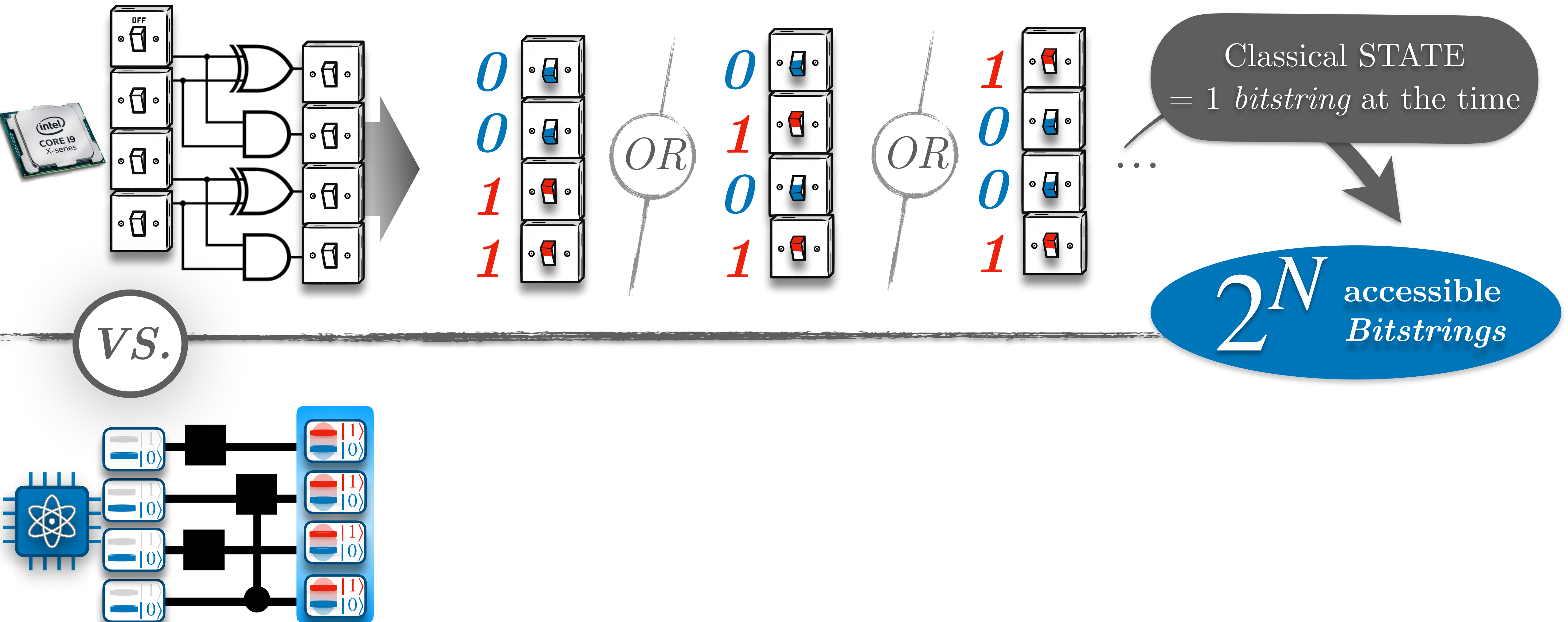

I) From quantum computing to quantum chemistry

ANSWER

How to encode/manipulate information in Qubits vs. Bits

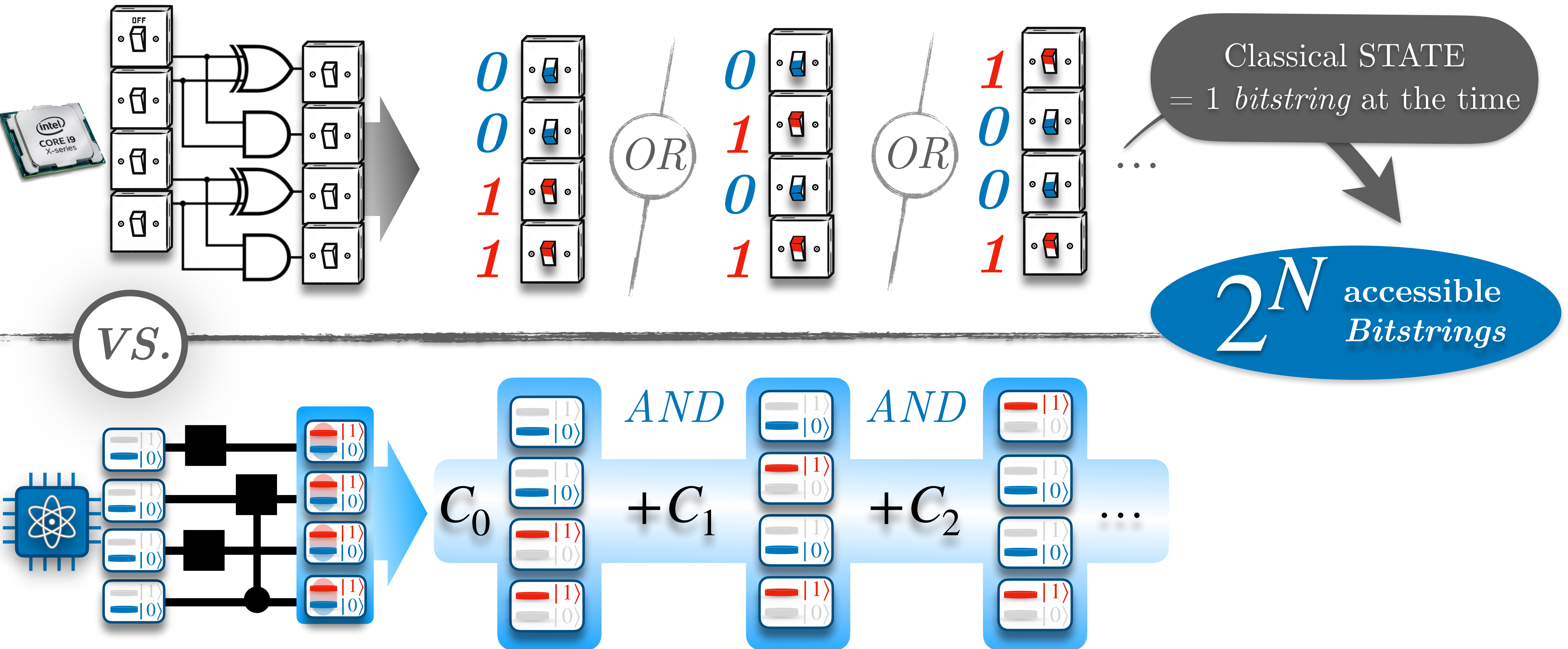

I) From quantum computing to quantum chemistry

ANSWER

How to encode/manipulate information in Qubits vs. Bits

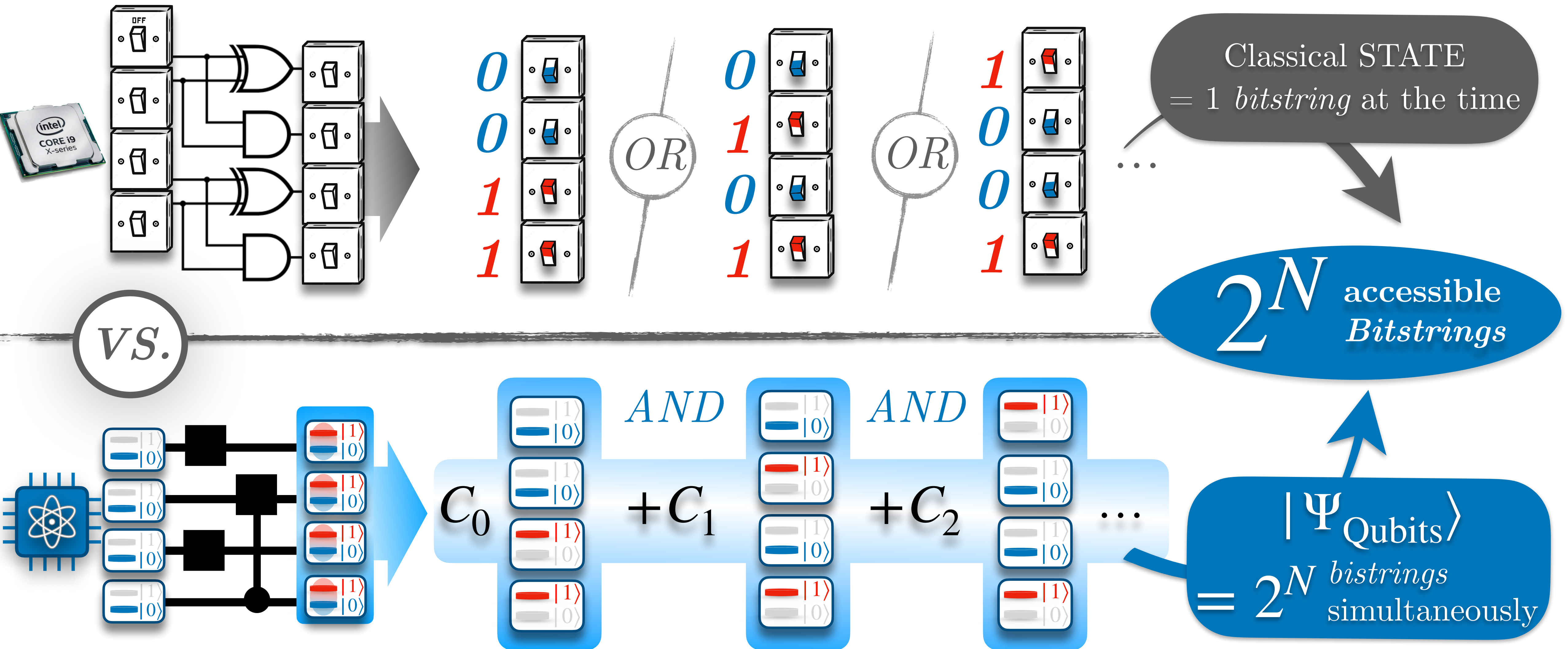

Example of Full Quantum Superposition

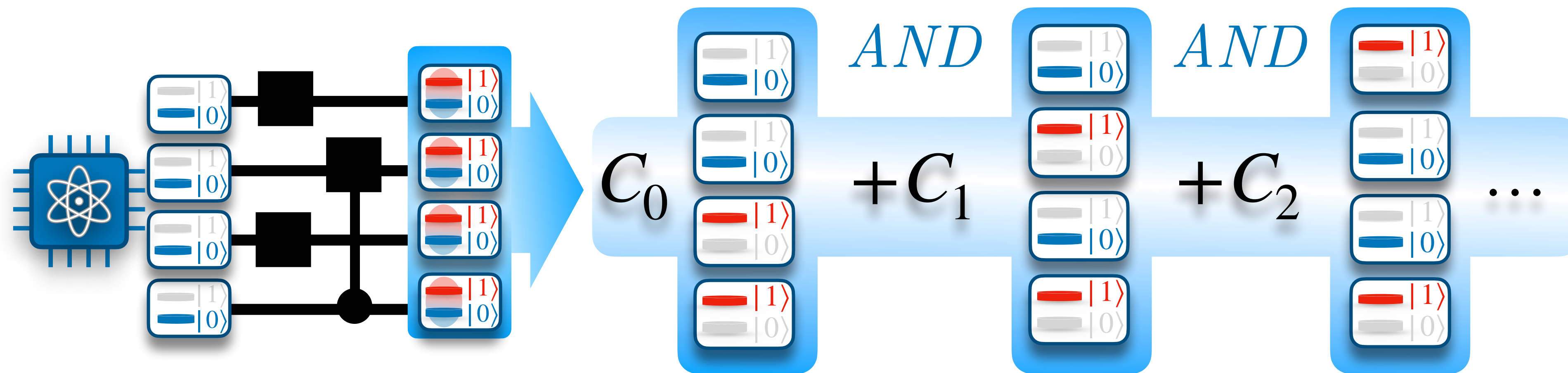

Let's build a quantum circuit !

Quantum Chemistry

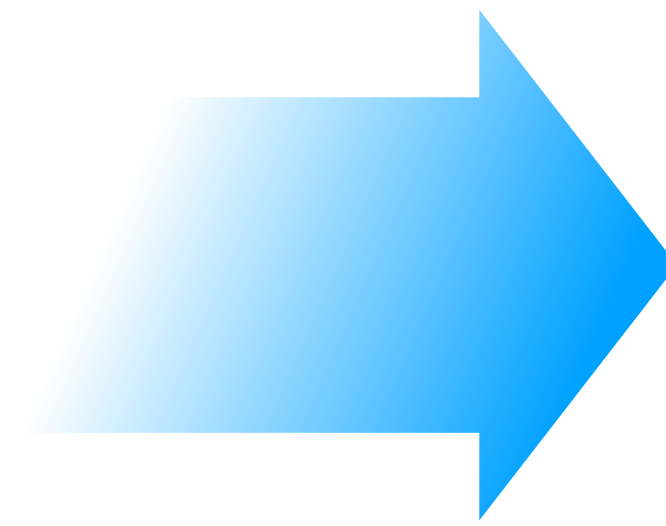
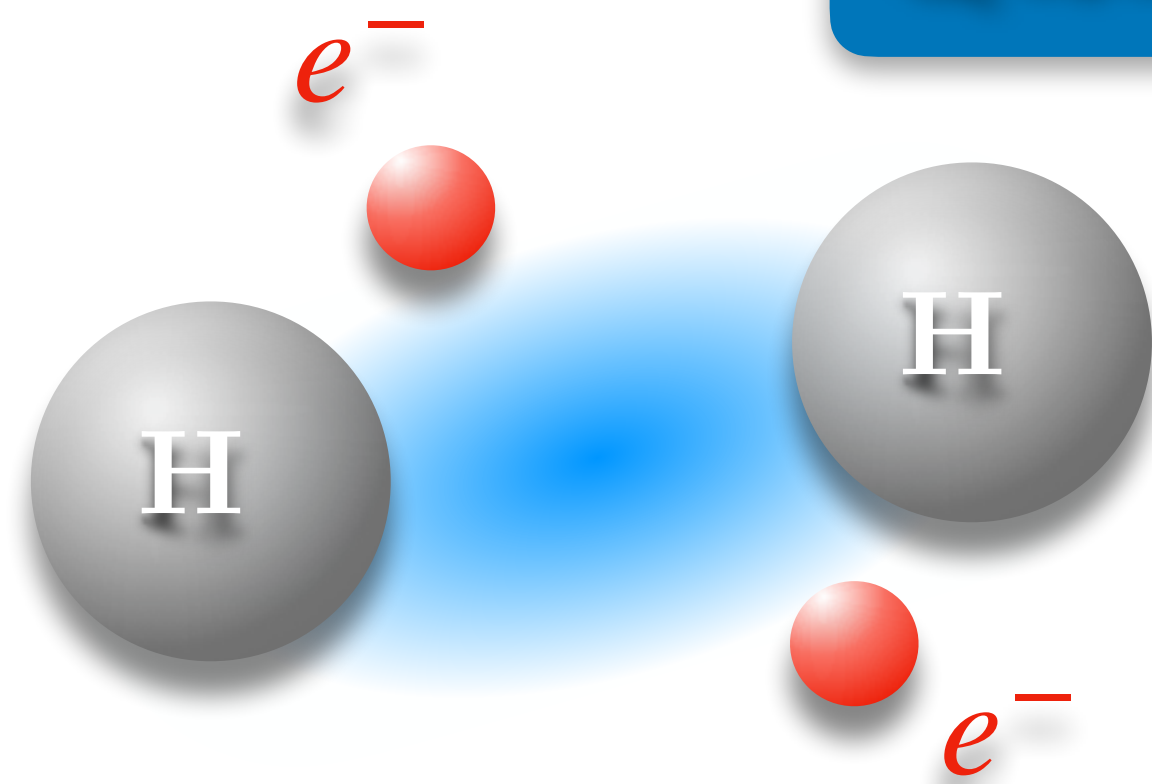

$$\hat{H} |\Psi_k\rangle = E_k |\Psi_k\rangle$$

Quantum Chemistry

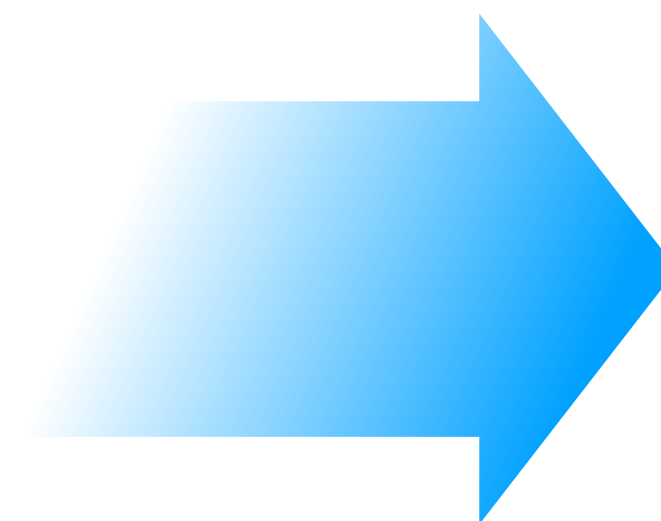
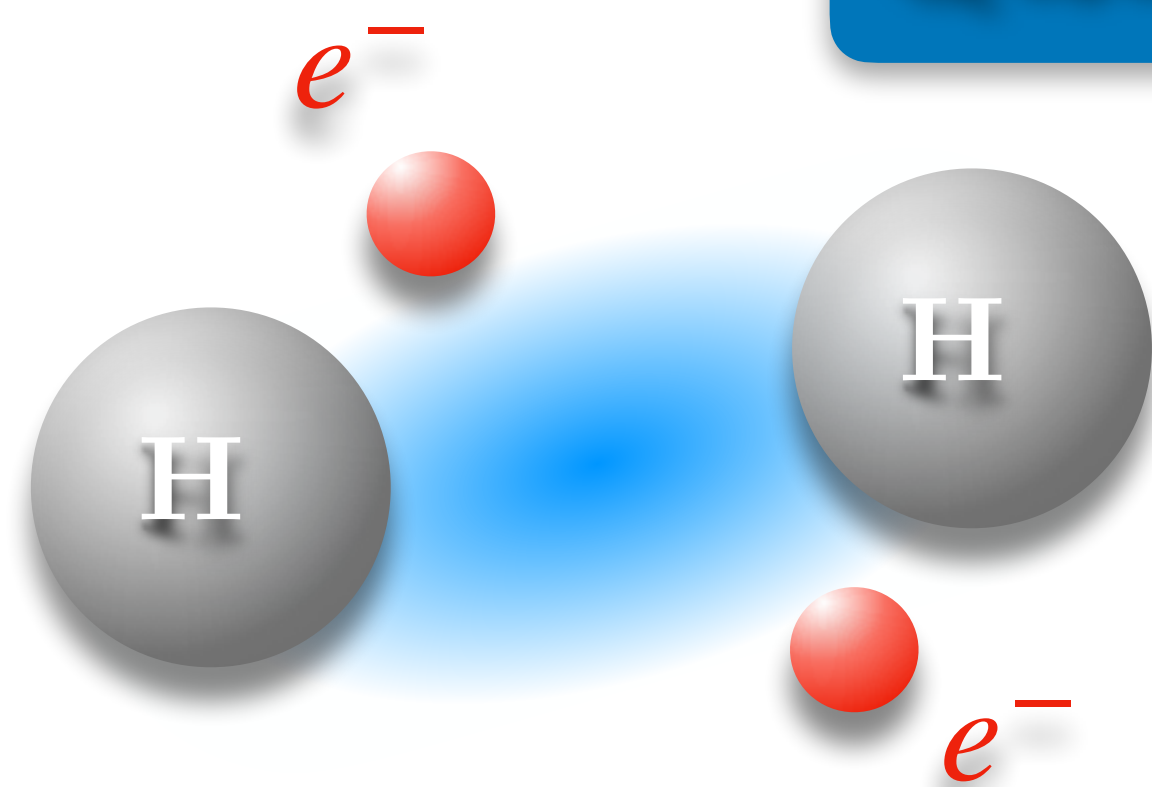

$$\hat{H} |\Psi_k\rangle = E_k |\Psi_k\rangle$$

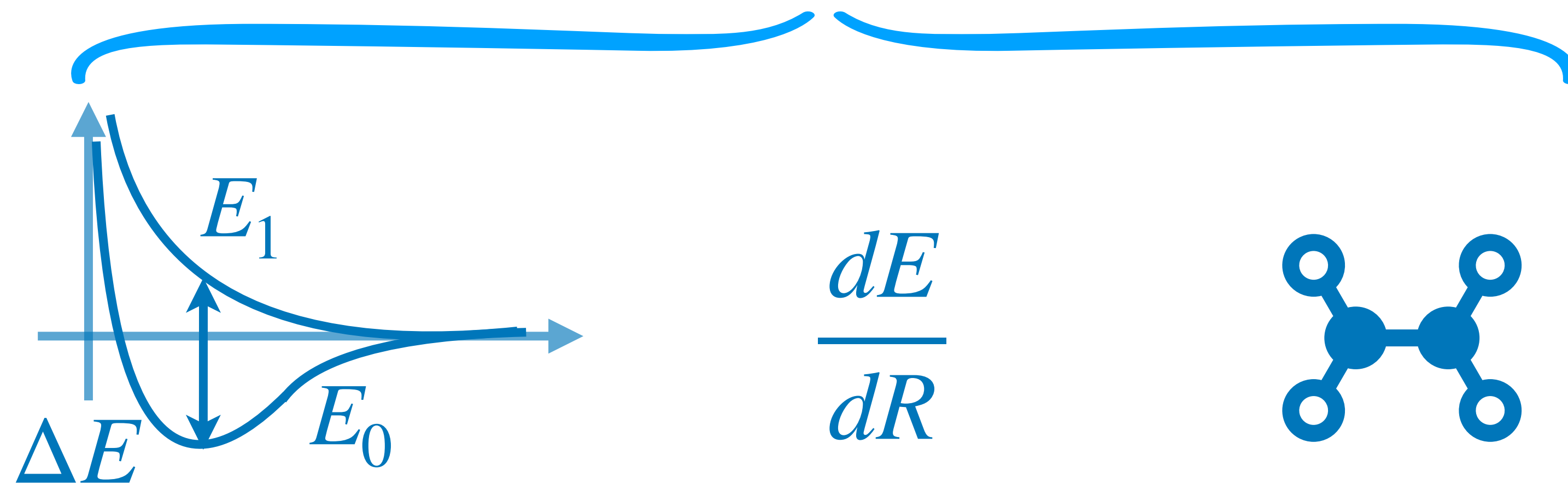

Potential Energy
Surfaces

Nuclear Forces
(Energy derivatives)

Stable Molecular
Geometries

I) From quantum computing to quantum chemistry

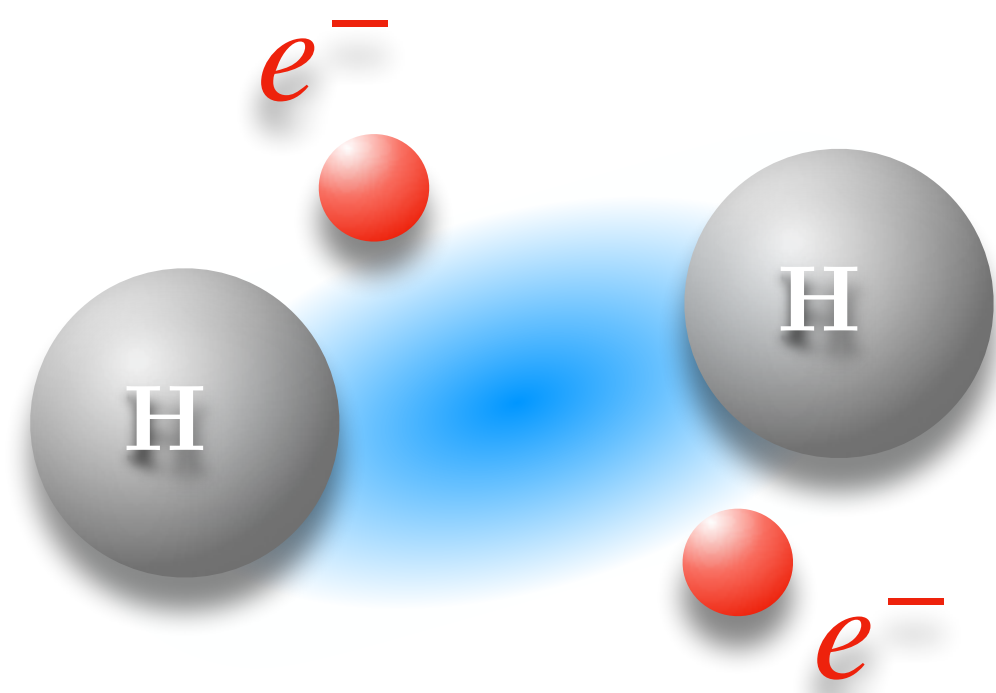

Electronic structure Hamiltonian
(Born-Oppenheimer approximation)

$$H = \sum_{pq}^{N_o} h_{pq} \sum_{\sigma}^{\{\uparrow, \downarrow\}} \hat{a}_{p\sigma}^{\dagger} \hat{a}_{q\sigma} + \frac{1}{2} \sum_{pqrs}^{N_o} g_{pqrs} \sum_{\sigma, \tau}^{\{\uparrow, \downarrow\}} \hat{a}_{p\sigma}^{\dagger} \hat{a}_{r\tau}^{\dagger} \hat{a}_{s\tau} \hat{a}_{q\sigma}$$

I) From quantum computing to quantum chemistry

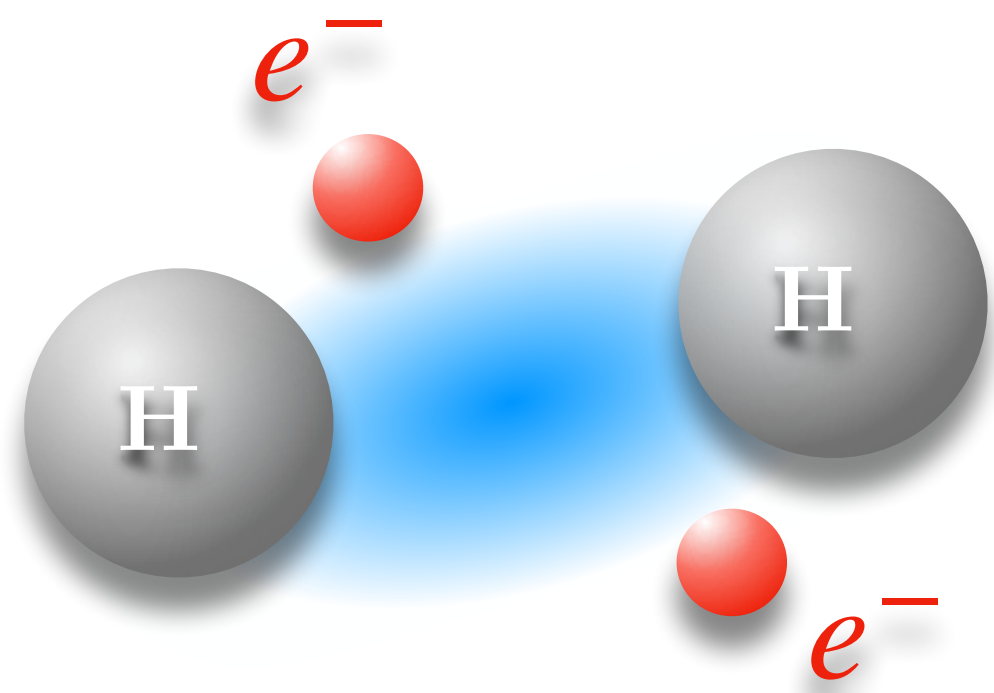

Electronic structure Hamiltonian
(Born-Oppenheimer approximation)

$$H = \sum_{pq}^{N_o} h_{pq} \sum_{\sigma}^{\{\uparrow, \downarrow\}} \hat{a}_{p\sigma}^\dagger \hat{a}_{q\sigma} + \frac{1}{2} \sum_{pqrs}^{N_o} g_{pqrs} \sum_{\sigma, \tau}^{\{\uparrow, \downarrow\}} \hat{a}_{p\sigma}^\dagger \hat{a}_{r\tau}^\dagger \hat{a}_{s\tau} \hat{a}_{q\sigma}$$

With 1- and 2-electron integrals

$$h_{pq} = \int \phi_p^*(\mathbf{r}_i) \left(-\frac{1}{2} \nabla_{\mathbf{r}_i}^2 - \sum_{A=1}^{N_a} \frac{Z_A}{|\mathbf{r}_i - \mathbf{R}_A|} \right) \phi_q(\mathbf{r}_i) d\mathbf{r}_i$$

$$g_{pqrs} = \iint \phi_p^*(\mathbf{r}_i) \phi_r^*(\mathbf{r}_j) \frac{1}{|\mathbf{r}_i - \mathbf{r}_j|} \phi_q(\mathbf{r}_i) \phi_s(\mathbf{r}_j) d\mathbf{r}_i d\mathbf{r}_j$$

I) From quantum computing to quantum chemistry

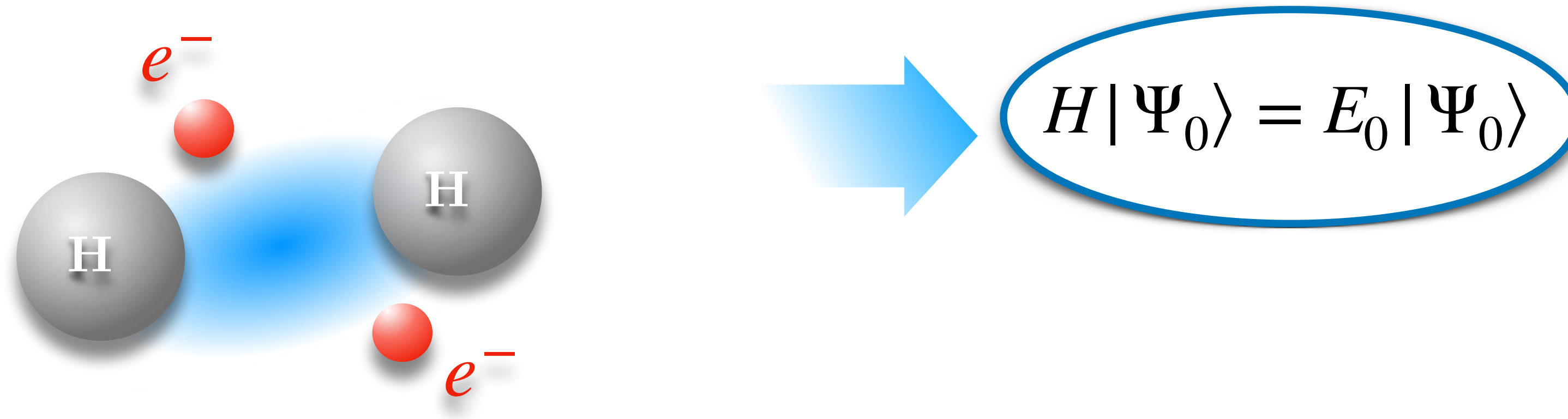

Electronic structure Hamiltonian
(Born-Oppenheimer approximation)

$$H = \sum_{pq}^{N_o} h_{pq} \sum_{\sigma}^{\{\uparrow,\downarrow\}} \hat{a}_{p\sigma}^\dagger \hat{a}_{q\sigma} + \frac{1}{2} \sum_{pqrs}^{N_o} g_{pqrs} \sum_{\sigma,\tau}^{\{\uparrow,\downarrow\}} \hat{a}_{p\sigma}^\dagger \hat{a}_{r\tau}^\dagger \hat{a}_{s\tau} \hat{a}_{q\sigma}$$

With 1- and 2-electron integrals

$$h_{pq} = \int \phi_p^*(\mathbf{r}_i) \left(-\frac{1}{2} \nabla_{\mathbf{r}_i}^2 - \sum_{A=1}^{N_a} \frac{Z_A}{|\mathbf{r}_i - \mathbf{R}_A|} \right) \phi_q(\mathbf{r}_i) d\mathbf{r}_i$$

$$g_{pqrs} = \iint \phi_p^*(\mathbf{r}_i) \phi_r^*(\mathbf{r}_j) \frac{1}{|\mathbf{r}_i - \mathbf{r}_j|} \phi_q(\mathbf{r}_i) \phi_s(\mathbf{r}_j) d\mathbf{r}_i d\mathbf{r}_j$$

I) From quantum computing to quantum chemistry

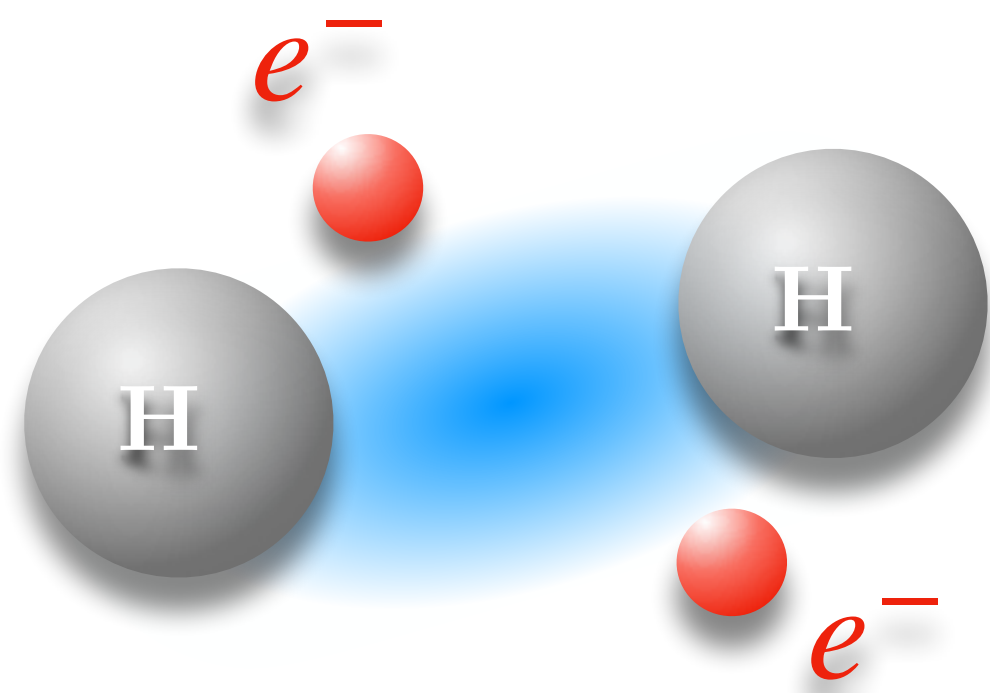

$$H|\Psi_0\rangle = E_0|\Psi_0\rangle$$

Mean-Field Approach
(Hartree-Fock)

Single Configuration
Approximation

$$|\Psi_0\rangle \approx |\Phi_{HF}\rangle$$

Electronic structure Hamiltonian
(Born-Oppenheimer approximation)

$$H = \sum_{pq} h_{pq} \sum_{\sigma \in \{\uparrow, \downarrow\}} \hat{a}_{p\sigma}^\dagger \hat{a}_{q\sigma} + \frac{1}{2} \sum_{pqrs} g_{pqrs} \sum_{\sigma, \tau \in \{\uparrow, \downarrow\}} \hat{a}_{p\sigma}^\dagger \hat{a}_{r\tau}^\dagger \hat{a}_{s\tau} \hat{a}_{q\sigma}$$

With 1- and 2-electron integrals

$$h_{pq} = \int \phi_p^*(\mathbf{r}_i) \left(-\frac{1}{2} \nabla_{\mathbf{r}_i}^2 - \sum_{A=1}^{N_a} \frac{Z_A}{|\mathbf{r}_i - \mathbf{R}_A|} \right) \phi_q(\mathbf{r}_i) d\mathbf{r}_i$$

$$g_{pqrs} = \iint \phi_p^*(\mathbf{r}_i) \phi_r^*(\mathbf{r}_j) \frac{1}{|\mathbf{r}_i - \mathbf{r}_j|} \phi_q(\mathbf{r}_i) \phi_s(\mathbf{r}_j) d\mathbf{r}_i d\mathbf{r}_j$$

I) From quantum computing to quantum chemistry

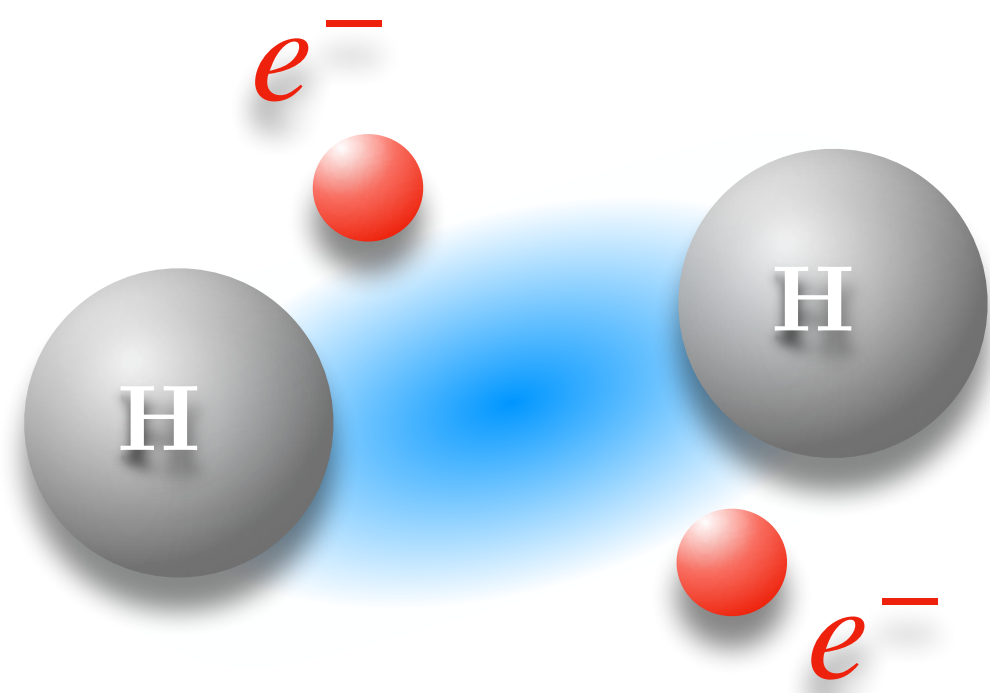

$$H|\Psi_0\rangle = E_0|\Psi_0\rangle$$

Mean-Field Approach (Hartree-Fock)

Electronic structure Hamiltonian
(Born-Oppenheimer approximation)

$$H = \sum_{pq} h_{pq} \sum_{\sigma}^{\{\uparrow,\downarrow\}} \hat{a}_{p\sigma}^\dagger \hat{a}_{q\sigma} + \frac{1}{2} \sum_{pqrs} g_{pqrs} \sum_{\sigma,\tau}^{\{\uparrow,\downarrow\}} \hat{a}_{p\sigma}^\dagger \hat{a}_{r\tau}^\dagger \hat{a}_{s\tau} \hat{a}_{q\sigma}$$

With 1- and 2-electron integrals

$$h_{pq} = \int \phi_p^*(\mathbf{r}_i) \left(-\frac{1}{2} \nabla_{\mathbf{r}_i}^2 - \sum_{A=1}^{N_a} \frac{Z_A}{|\mathbf{r}_i - \mathbf{R}_A|} \right) \phi_q(\mathbf{r}_i) d\mathbf{r}_i$$

$$g_{pqrs} = \iint \phi_p^*(\mathbf{r}_i) \phi_r^*(\mathbf{r}_j) \frac{1}{|\mathbf{r}_i - \mathbf{r}_j|} \phi_q(\mathbf{r}_i) \phi_s(\mathbf{r}_j) d\mathbf{r}_i d\mathbf{r}_j$$

Single Configuration
Approximation

$$|\Psi_0\rangle \approx |\Phi_{HF}\rangle$$

Molecular Orbitals

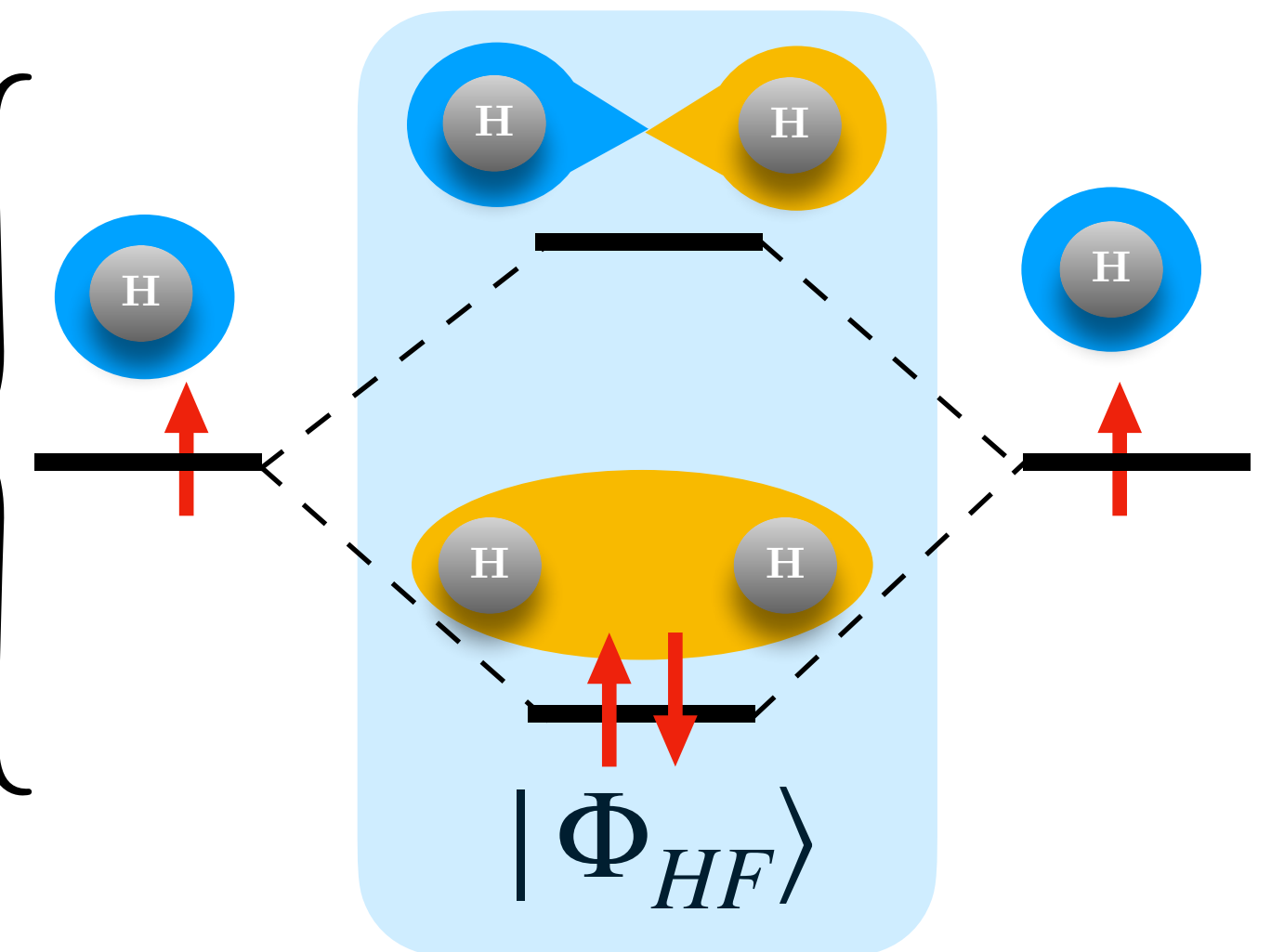

I) From quantum computing to quantum chemistry

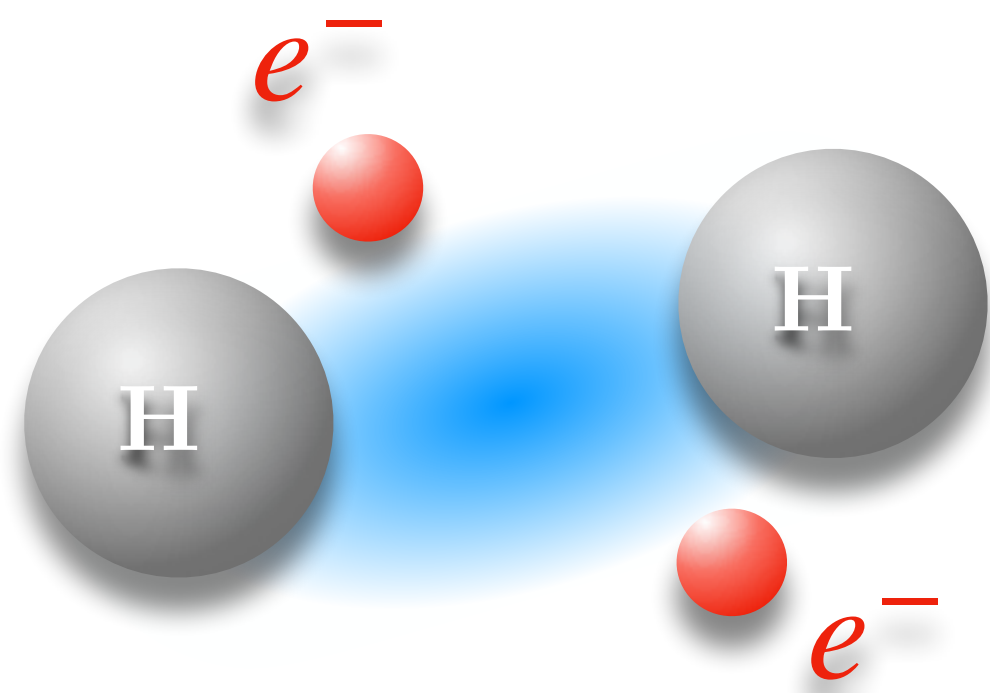

$$H|\Psi_0\rangle = E_0|\Psi_0\rangle$$

Mean-Field Approach (Hartree-Fock)

Electronic structure Hamiltonian
(Born-Oppenheimer approximation)

$$H = \sum_{pq} h_{pq} \sum_{\sigma}^{\{\uparrow,\downarrow\}} \hat{a}_{p\sigma}^\dagger \hat{a}_{q\sigma} + \frac{1}{2} \sum_{pqrs} g_{pqrs} \sum_{\sigma,\tau}^{\{\uparrow,\downarrow\}} \hat{a}_{p\sigma}^\dagger \hat{a}_{r\tau}^\dagger \hat{a}_{s\tau} \hat{a}_{q\sigma}$$

With 1- and 2-electron integrals

$$h_{pq} = \int \phi_p^*(\mathbf{r}_i) \left(-\frac{1}{2} \nabla_{\mathbf{r}_i}^2 - \sum_{A=1}^{N_a} \frac{Z_A}{|\mathbf{r}_i - \mathbf{R}_A|} \right) \phi_q(\mathbf{r}_i) d\mathbf{r}_i$$

$$g_{pqrs} = \iint \phi_p^*(\mathbf{r}_i) \phi_r^*(\mathbf{r}_j) \frac{1}{|\mathbf{r}_i - \mathbf{r}_j|} \phi_q(\mathbf{r}_i) \phi_s(\mathbf{r}_j) d\mathbf{r}_i d\mathbf{r}_j$$

Single Configuration
Approximation

$$|\Psi_0\rangle \approx |\Phi_{HF}\rangle$$

Spin-Orbitals

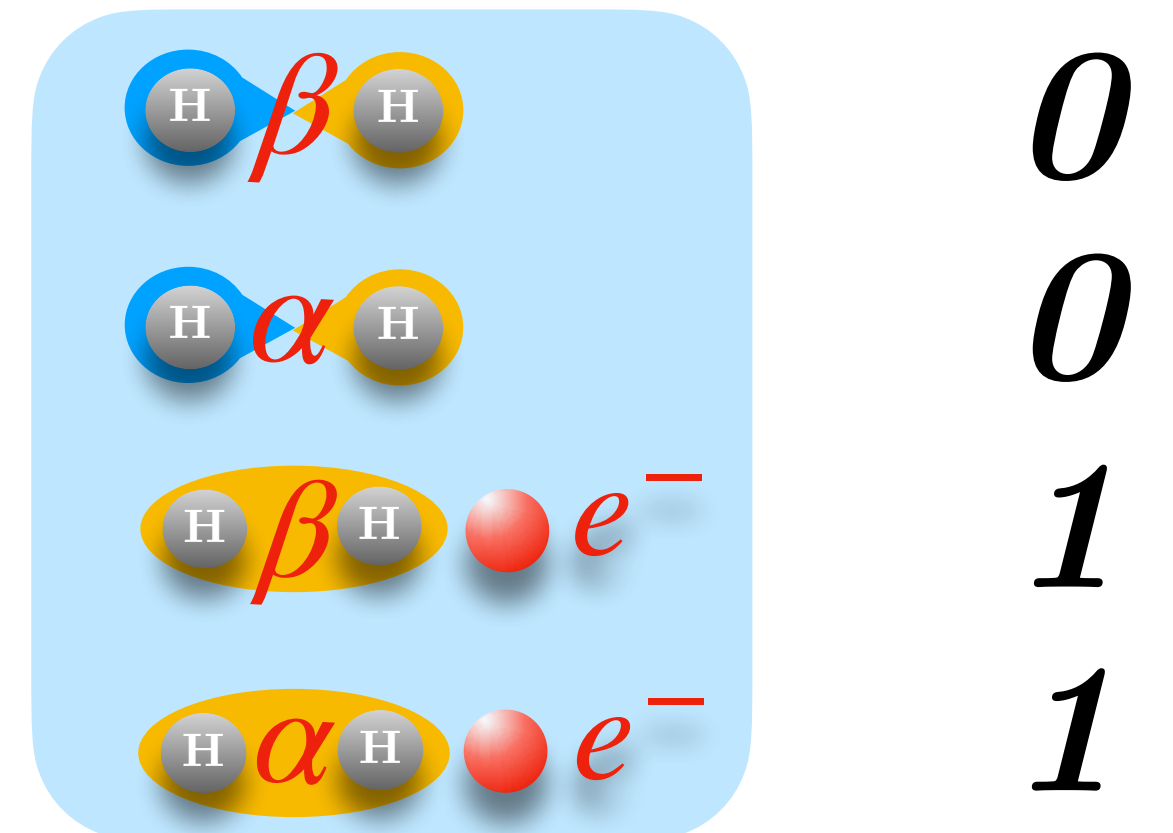

$$|\Phi_{HF}\rangle = |1100\rangle$$

Beyond Hartree-Fock: Full Configuration Interaction

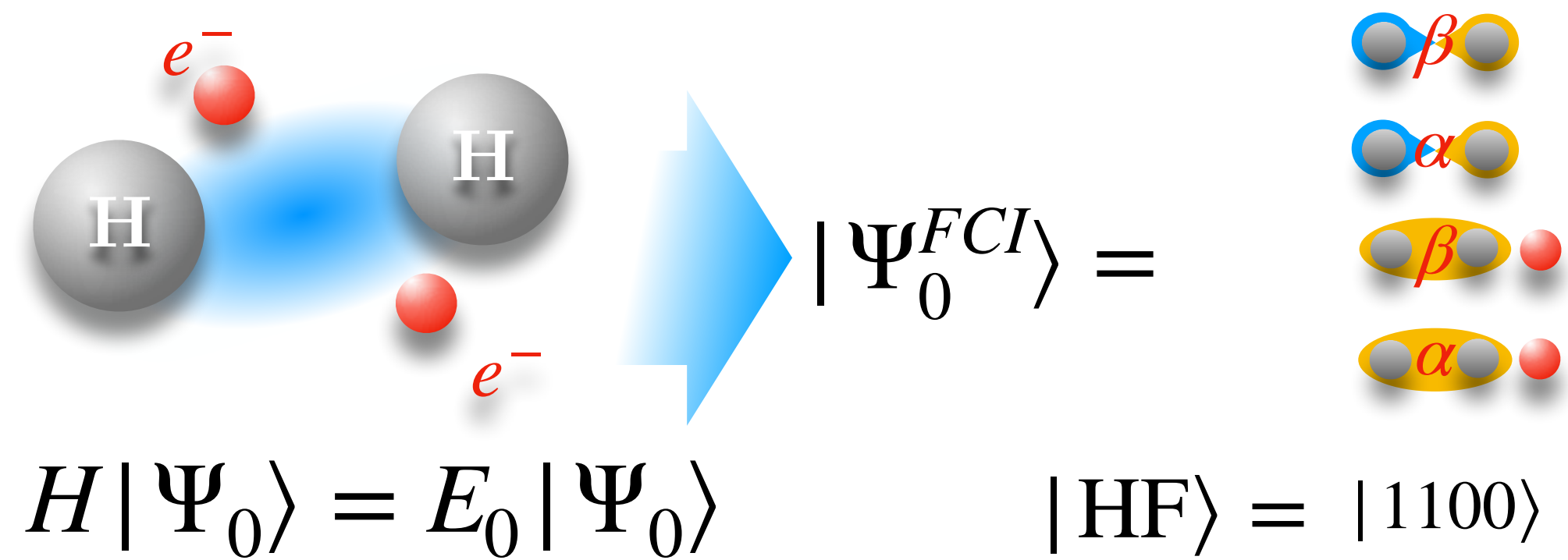

I) From quantum computing to quantum chemistry

Beyond Hartree-Fock: Full Configuration Interaction

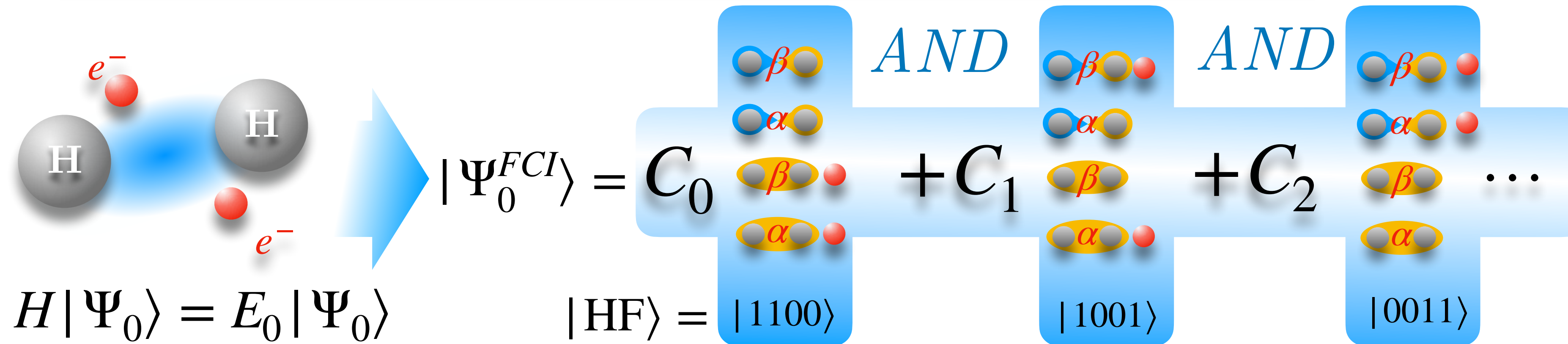

I) From quantum computing to quantum chemistry

Beyond Hartree-Fock: Full Configuration Interaction

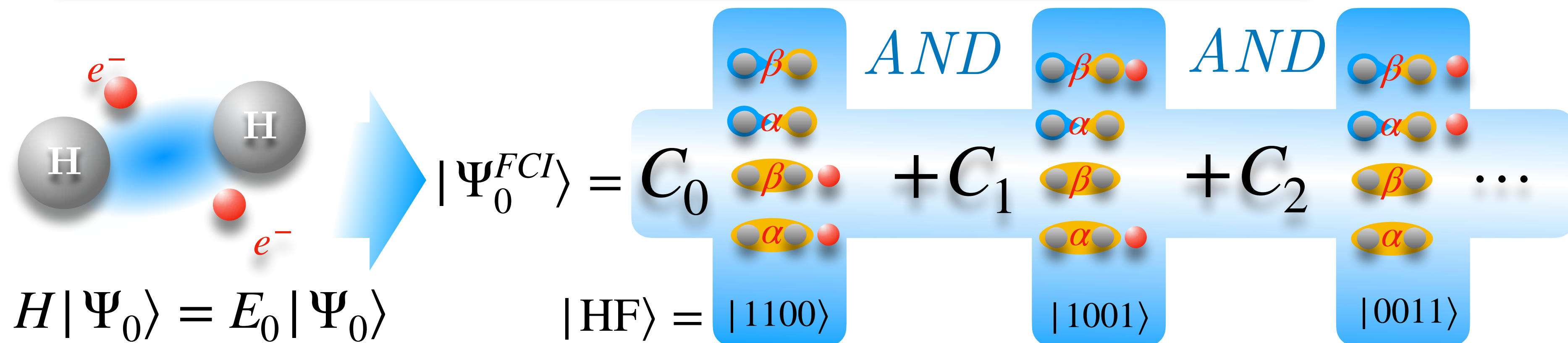

Problem:
FCI = Expensive!

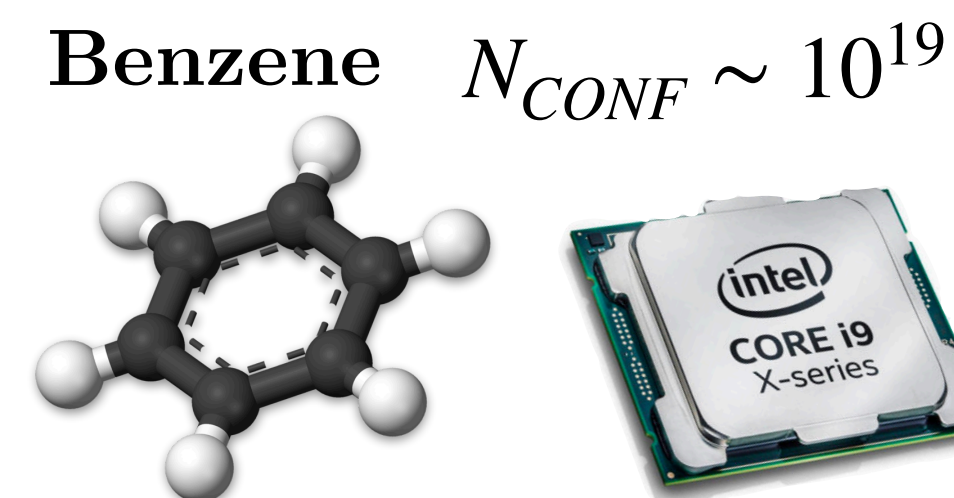

I) From quantum computing to quantum chemistry

Beyond Hartree-Fock: Full Configuration Interaction

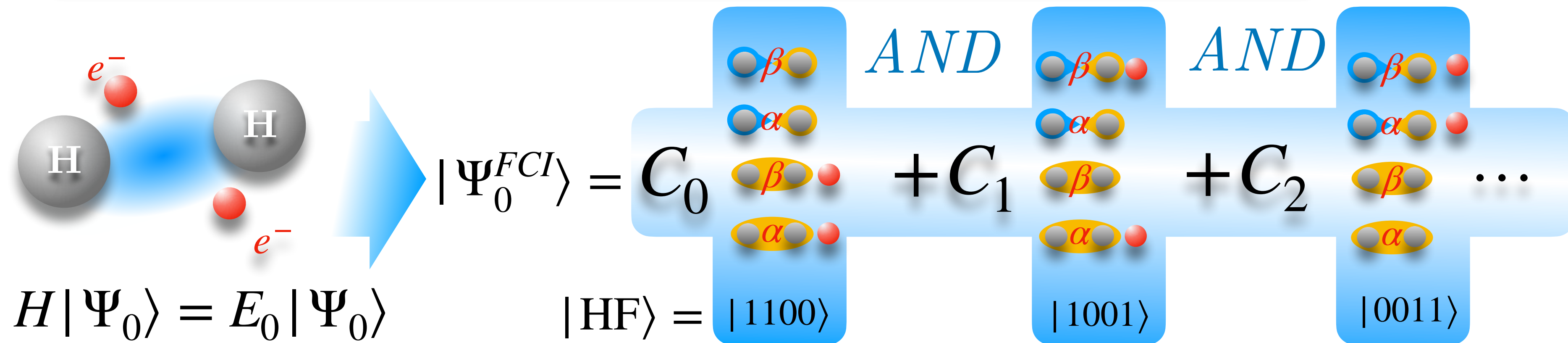

Problem:
FCI = Expensive!

Benzene $N_{CONF} \sim 10^{19}$

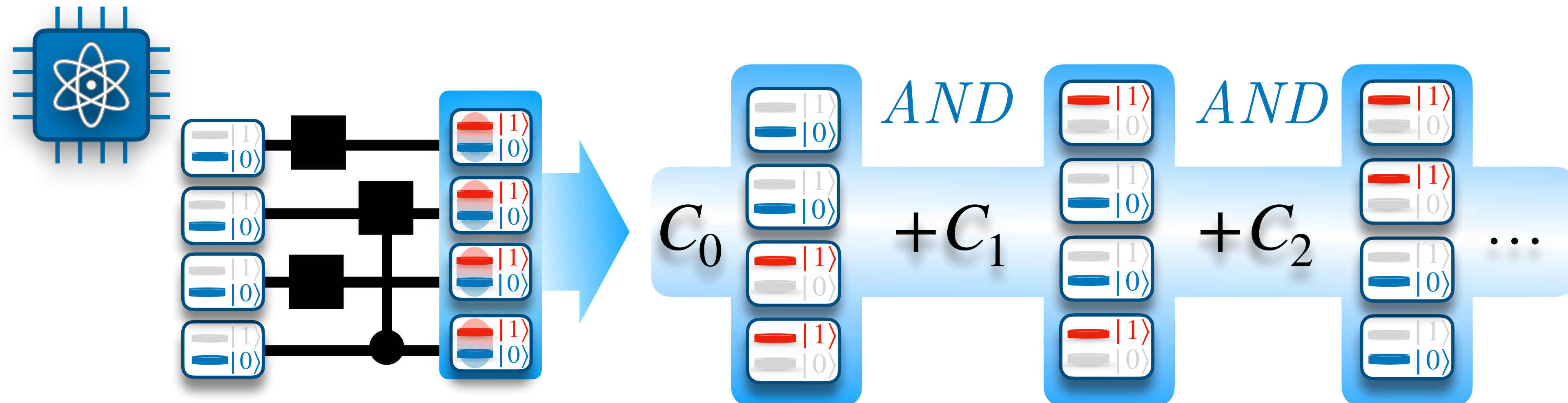

I) From quantum computing to quantum chemistry

Beyond Hartree-Fock: Full Configuration Interaction

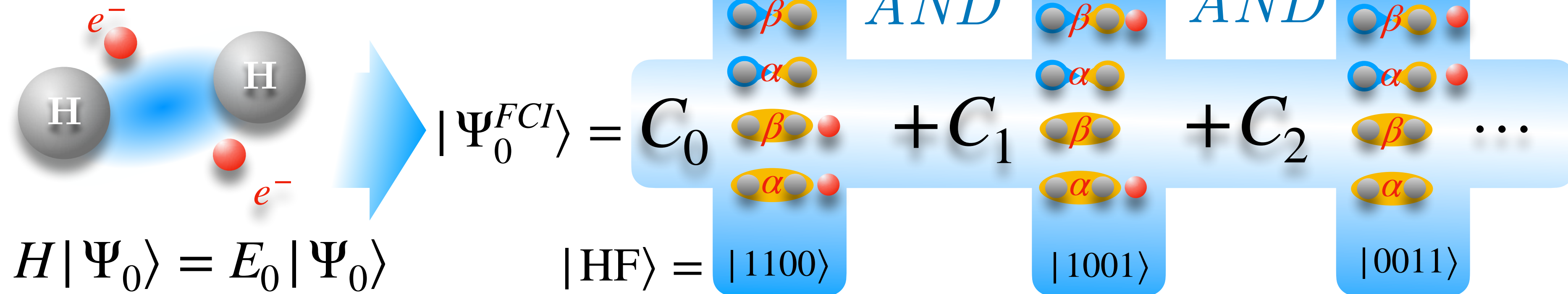

Problem:
FCI = Expensive!

Benzene $N_{CONF} \sim 10^{19}$

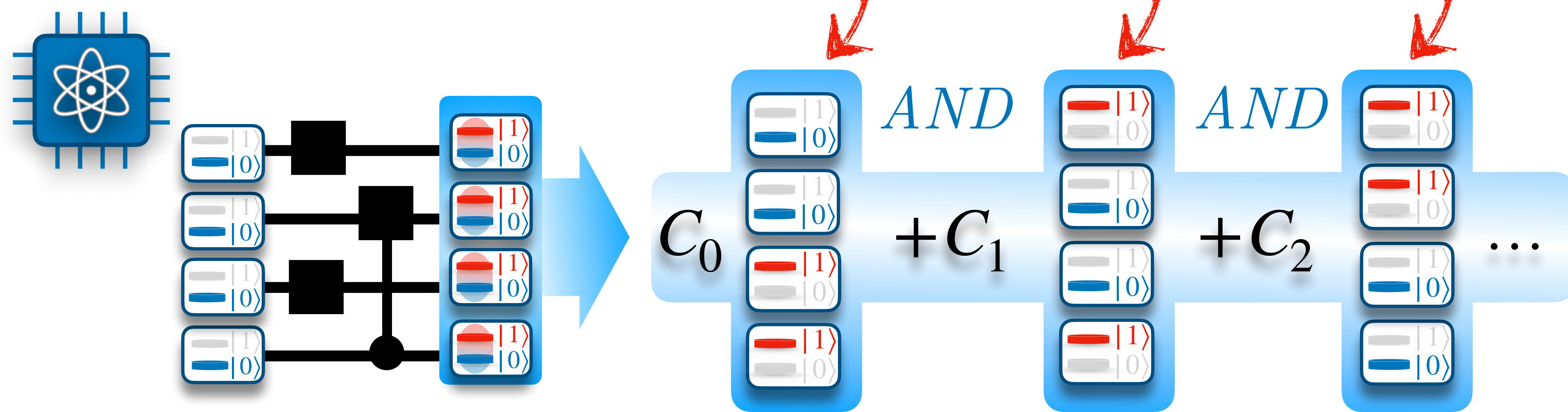

I) From quantum computing to quantum chemistry

Beyond Hartree-Fock: Full Configuration Interaction

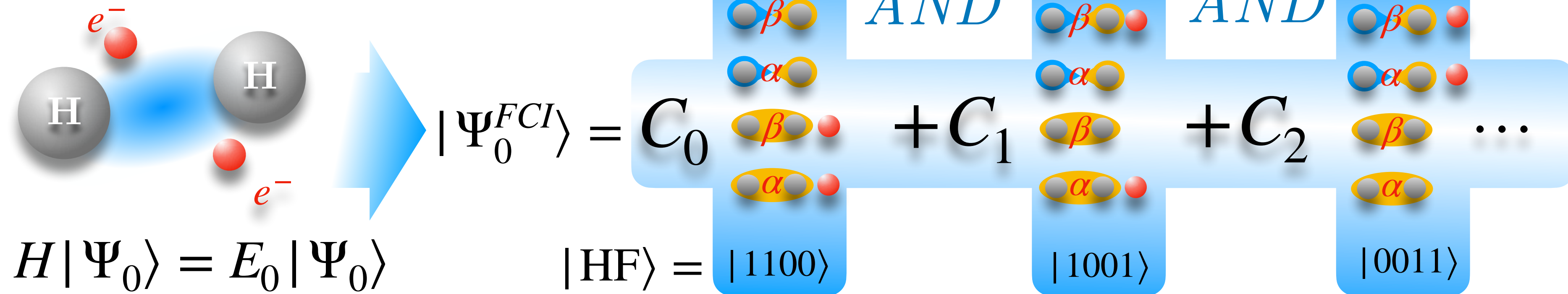

Problem:
FCI = Expensive!

Benzene $N_{CONF} \sim 10^{19}$

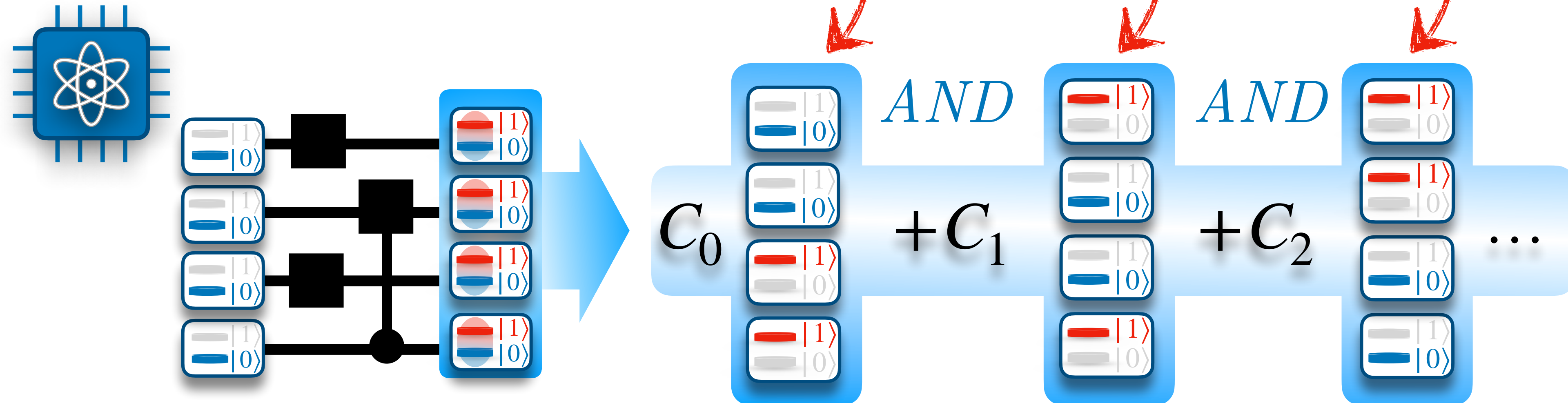

HOW TO
Connect
Both Worlds?

II) Electronic Structure on a Quantum Computer



-Richard P. Feynman

“Nature (e.g. atoms, molecules ...) isn't classical and if you want to make a simulation of nature, you'd better make it quantum mechanical.”

Jordan-Wigner Mapping (Fermion to qubit)

Jordan-Wigner Mapping (Fermion to qubit)

→ 1-to-1 Physical Correspondence

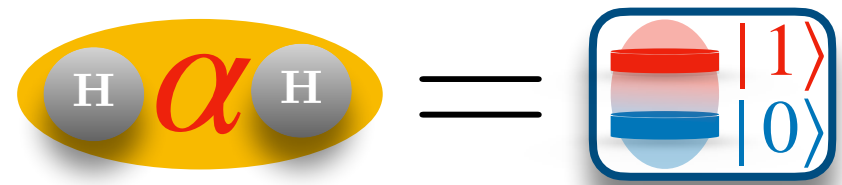

Jordan-Wigner Mapping (Fermion to qubit)

→ 1-to-1 Physical Correspondence



Jordan-Wigner Mapping (Fermion to qubit)

→ 1-to-1 Physical Correspondence



Jordan-Wigner Mapping (Fermion to qubit)

→ 1-to-1 Physical Correspondence



→ Translation of Fermionic Algebra

Pauli Operators

$$X = |0\rangle\langle 1| + |1\rangle\langle 0|$$

$$Y = -i|0\rangle\langle 1| + i|1\rangle\langle 0|$$

$$Z = |0\rangle\langle 0| - |1\rangle\langle 1|$$

Jordan-Wigner Mapping (Fermion to qubit)

→ 1-to-1 Physical Correspondence



→ Translation of Fermionic Algebra

Pauli Operators

$$X = |0\rangle\langle 1| + |1\rangle\langle 0|$$

$$Y = -i|0\rangle\langle 1| + i|1\rangle\langle 0|$$

$$Z = |0\rangle\langle 0| - |1\rangle\langle 1|$$



$$\hat{a}_p^\dagger = \frac{X_p - iY_p}{2} \bigotimes_{q=0}^{p-1} Z_q$$

II) Electronic structure on a Quantum Computer

Jordan-Wigner Mapping (Fermion to qubit)

→ 1-to-1 Physical Correspondence



→ Translation of Fermionic Algebra

Pauli Operators

$$X = |0\rangle\langle 1| + |1\rangle\langle 0|$$

$$Y = -i|0\rangle\langle 1| + i|1\rangle\langle 0|$$

$$Z = |0\rangle\langle 0| - |1\rangle\langle 1|$$

$$\hat{a}_p^\dagger = \frac{X_p - iY_p}{2} \bigotimes_{q=0}^{p-1} Z_q$$

$$|1_p\rangle\langle 0_p|$$

Creating 1 electron
in the qubit/spinorbital "p"

II) Electronic structure on a Quantum Computer

Jordan-Wigner Mapping (Fermion to qubit)

1-to-1 Physical Correspondence



Translation of Fermionic Algebra

Pauli Operators

$$X = |0\rangle\langle 1| + |1\rangle\langle 0|$$

$$Y = -i|0\rangle\langle 1| + i|1\rangle\langle 0|$$

$$Z = |0\rangle\langle 0| - |1\rangle\langle 1|$$

$$\hat{a}_p^\dagger = \frac{X_p - iY_p}{2} \bigotimes_{q=0}^{p-1} Z_q$$

$$|1_p\rangle\langle 0_p|$$

Creating 1 electron
in the qubit/spinorbital "p"

Ensuring fermionic
anti-symmetry

II) Electronic structure on a Quantum Computer

Jordan-Wigner Mapping (Fermion to qubit)

1-to-1 Physical Correspondence



Translation of Fermionic Algebra

Pauli Operators

$$X = |0\rangle\langle 1| + |1\rangle\langle 0|$$

$$Y = -i|0\rangle\langle 1| + i|1\rangle\langle 0|$$

$$Z = |0\rangle\langle 0| - |1\rangle\langle 1|$$

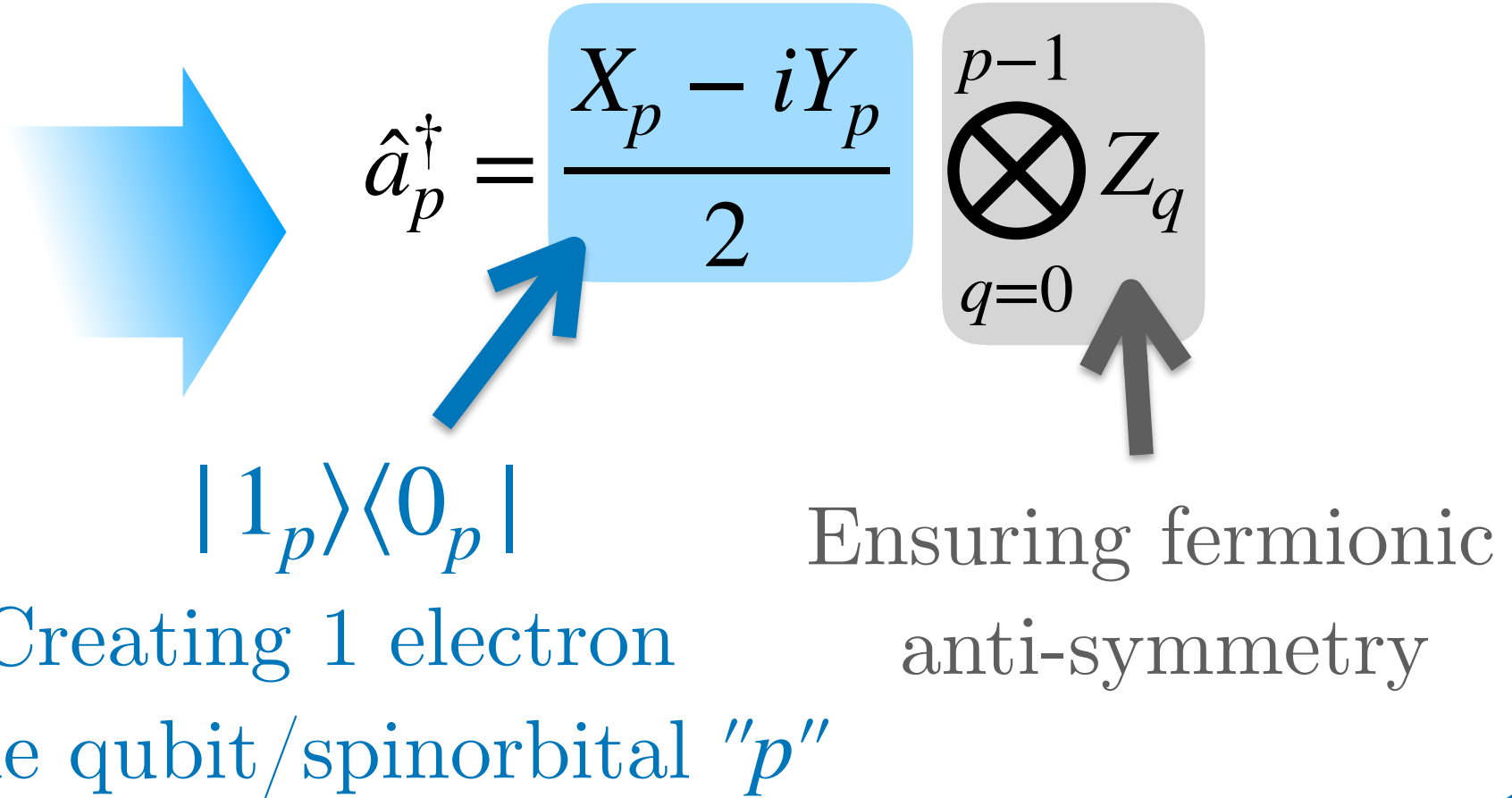

What Possibilities ?

- We can express fermionic operators (products of \hat{a}^\dagger/\hat{a}) in Qubit algebra

$$\hat{O}^{\text{ferm.}} \longrightarrow \hat{O}^{\text{Qubits}} = \sum_K h_K \hat{\mathcal{P}}_K$$

Pauli Strings $\hat{\mathcal{P}}_K = Y_0 \otimes X_1 \otimes Z_2 \otimes \dots$

II) Electronic structure on a Quantum Computer

Jordan-Wigner Mapping (Fermion to qubit)

1-to-1 Physical Correspondence



Translation of Fermionic Algebra

Pauli Operators

$$X = |0\rangle\langle 1| + |1\rangle\langle 0|$$

$$Y = -i|0\rangle\langle 1| + i|1\rangle\langle 0|$$

$$Z = |0\rangle\langle 0| - |1\rangle\langle 1|$$

$$\hat{a}_p^\dagger = \frac{X_p - iY_p}{2} \bigotimes_{q=0}^{p-1} Z_q$$

$|1_p\rangle\langle 0_p|$

Creating 1 electron
in the qubit/spinorbital "p"

Ensuring fermionic
anti-symmetry

What Possibilities ?

- We can express fermionic operators (products of \hat{a}^\dagger/\hat{a}) in Qubit algebra

$$\hat{O}^{\text{ferm.}} \longrightarrow \hat{O}^{\text{Qubits}} = \sum_K h_K \hat{\mathcal{P}}_K$$

Pauli Strings $\hat{\mathcal{P}}_K = Y_0 \otimes X_1 \otimes Z_2 \otimes \dots$

- We can measure these operators

$$\langle \hat{O}^{\text{Qubits}} \rangle_{\Psi^{\text{Qubits}}} = \sum_K h_K \langle \hat{\mathcal{P}}_K \rangle_{\Psi^{\text{Qubits}}}$$

II) Electronic structure on a Quantum Computer

Jordan-Wigner Mapping (Fermion to qubit)

1-to-1 Physical Correspondence



Translation of Fermionic Algebra

Pauli Operators

$$X = |0\rangle\langle 1| + |1\rangle\langle 0|$$

$$Y = -i|0\rangle\langle 1| + i|1\rangle\langle 0|$$

$$Z = |0\rangle\langle 0| - |1\rangle\langle 1|$$

$$\hat{a}_p^\dagger = \frac{X_p - iY_p}{2} \bigotimes_{q=0}^{p-1} Z_q$$

$|1_p\rangle\langle 0_p|$

Creating 1 electron
in the qubit/spinorbital "p"

Ensuring fermionic
anti-symmetry

What Possibilities ?

- We can express fermionic operators (products of \hat{a}^\dagger/\hat{a}) in Qubit algebra

$$\hat{O}^{\text{ferm.}} \longrightarrow \hat{O}^{\text{Qubits}} = \sum_K h_K \hat{\mathcal{P}}_K$$

Pauli Strings $\hat{\mathcal{P}}_K = Y_0 \otimes X_1 \otimes Z_2 \otimes \dots$

- We can measure these operators

$$\langle \hat{O}^{\text{Qubits}} \rangle_{\Psi^{\text{Qubits}}} = \sum_K h_K \langle \hat{\mathcal{P}}_K \rangle_{\Psi^{\text{Qubits}}}$$

- We can encode fermionic unitaries in a quantum circuit

$$\exp(\hat{T} - \hat{T}^\dagger) \exp(-it\hat{H})$$

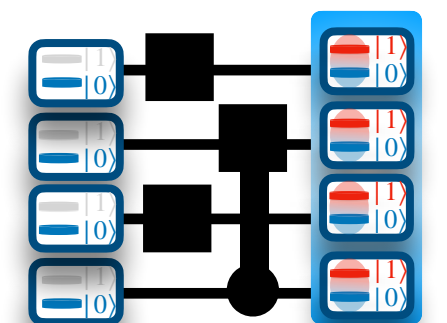

II) Electronic structure on a Quantum Computer

Jordan-Wigner
mapping

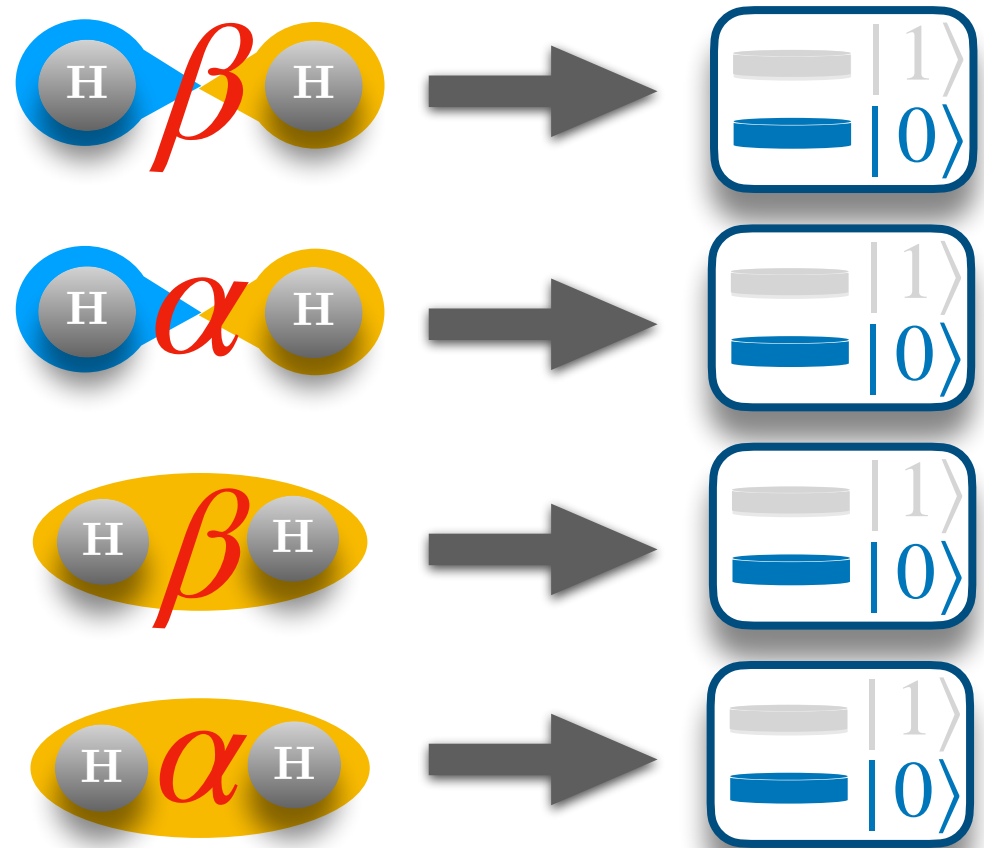

II) Electronic structure on a Quantum Computer

Jordan-Wigner
mapping

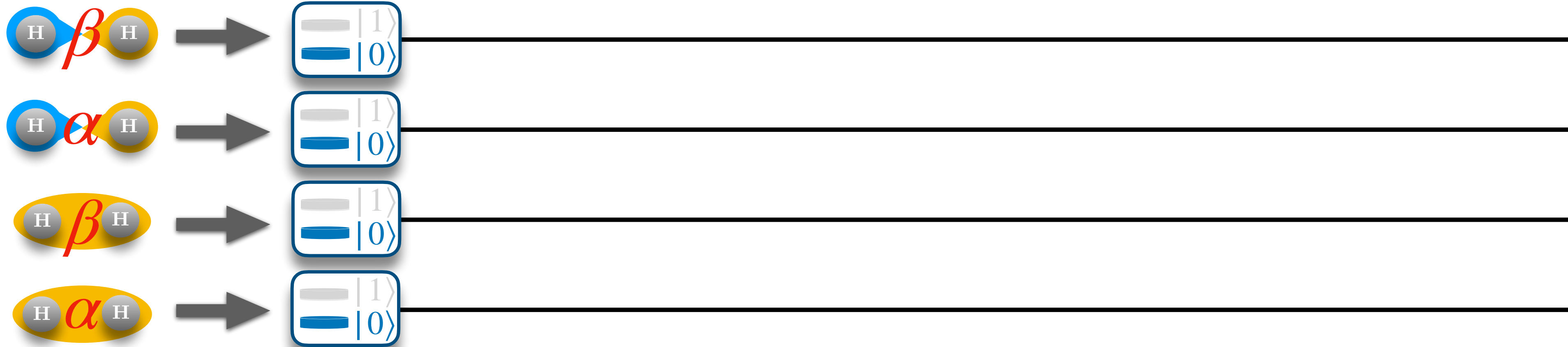

II) Electronic structure on a Quantum Computer

Jordan-Wigner
mapping

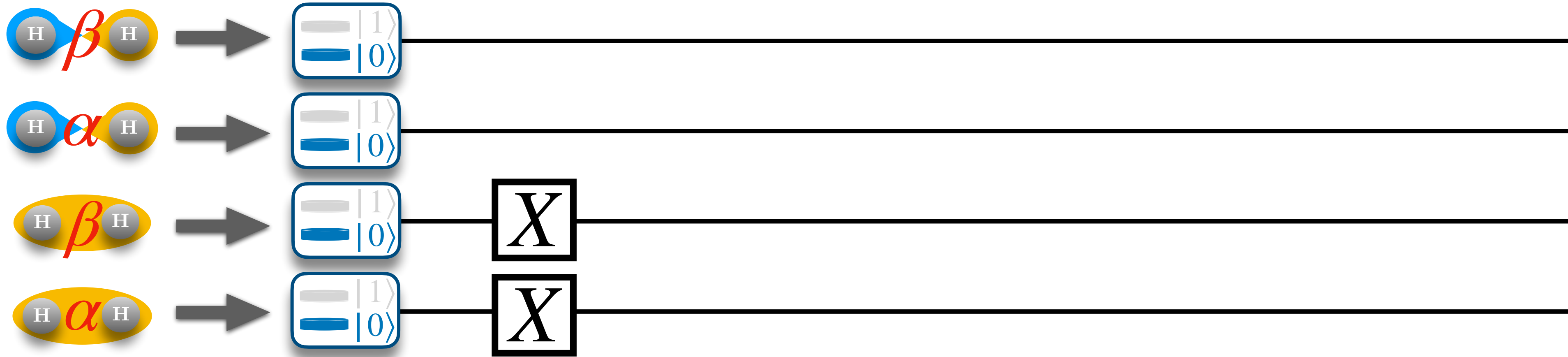

II) Electronic structure on a Quantum Computer

Jordan-Wigner
mapping

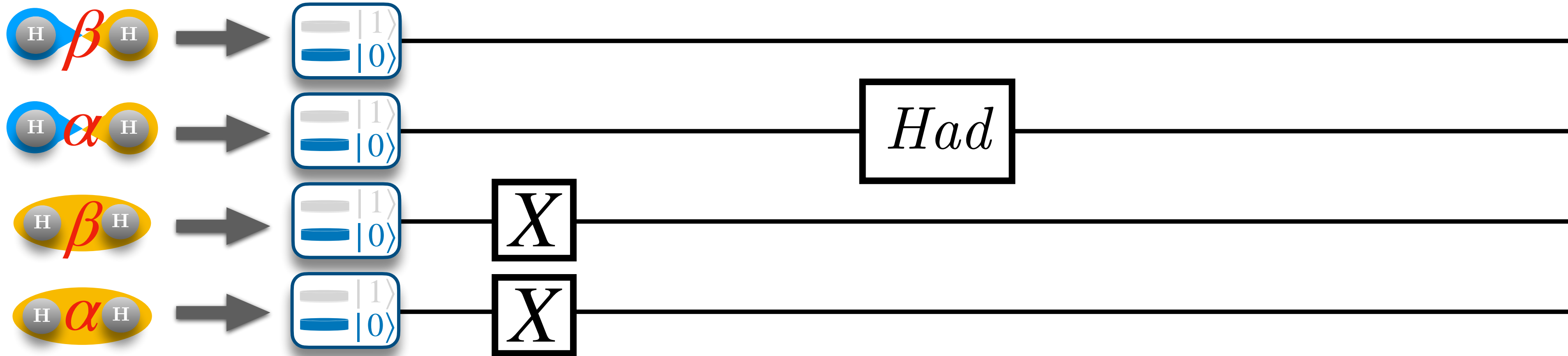

II) Electronic structure on a Quantum Computer

Jordan-Wigner
mapping

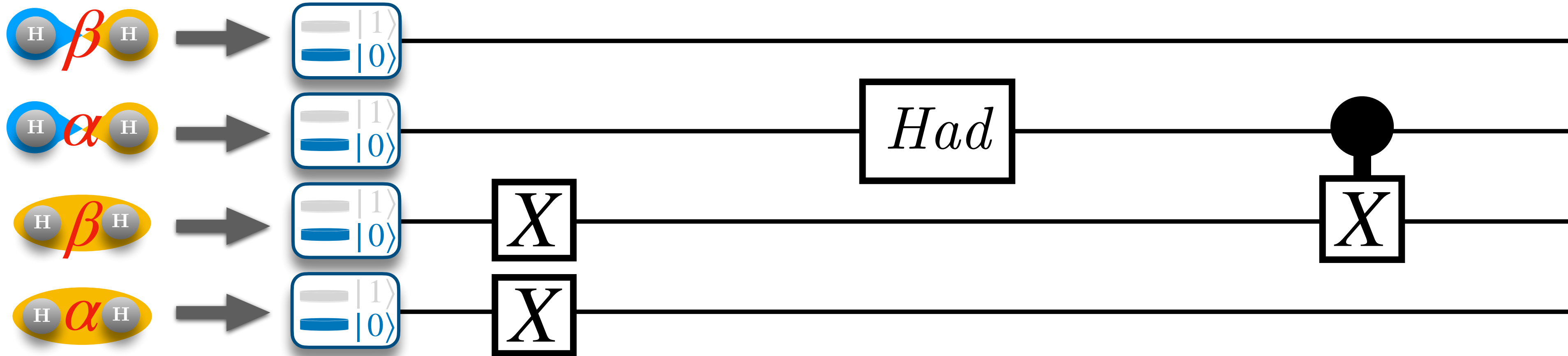

II) Electronic structure on a Quantum Computer

QUESTION

What is the final state of the qubit register (i.e. the molecule)?

Jordan-Wigner
mapping

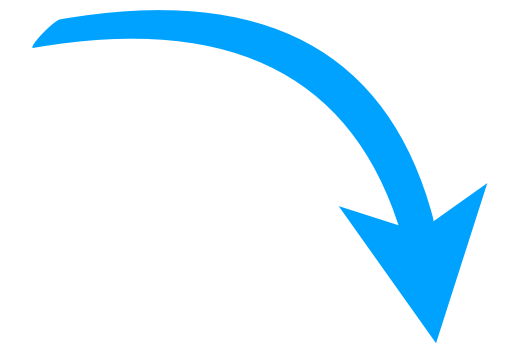
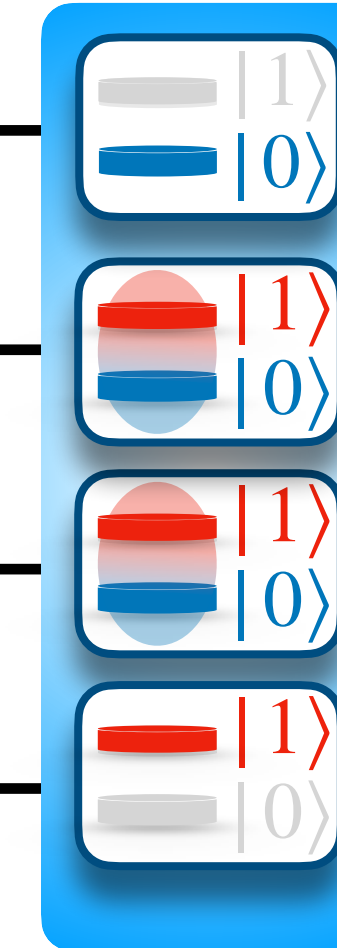
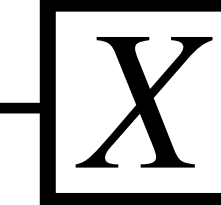
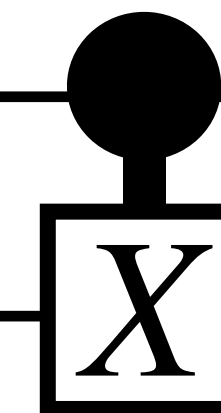
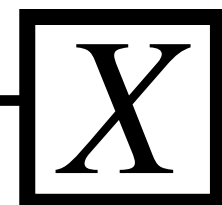
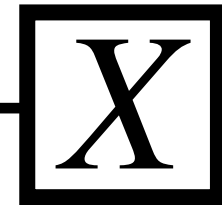
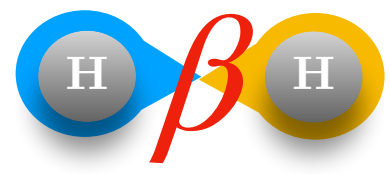

$|\Psi_{Qubits}\rangle?$

II) Electronic structure on a Quantum Computer

QUESTION

What is the final state of the qubit register (i.e. the molecule)?

Jordan-Wigner
mapping

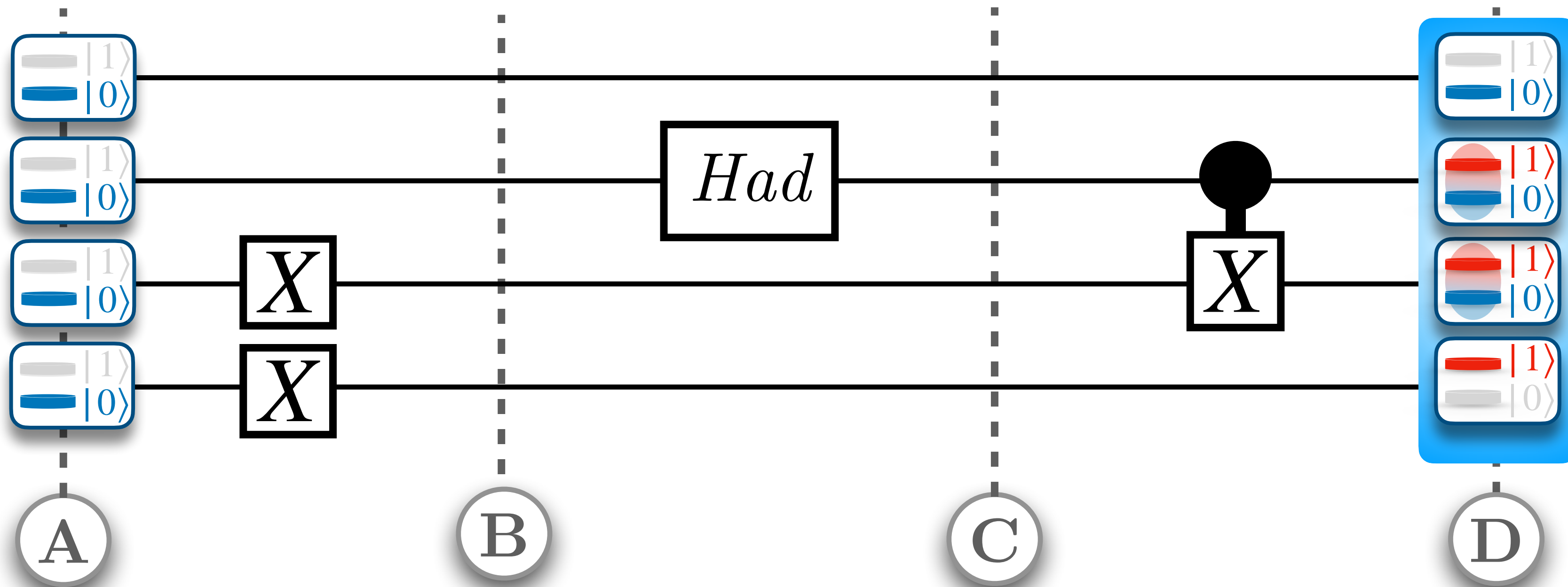
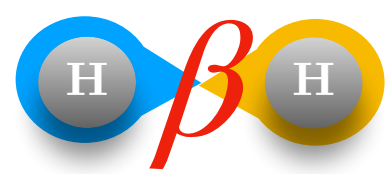

$|\Psi_{Qubits}\rangle?$

II) Electronic structure on a Quantum Computer

QUESTION

What is the final state of the qubit register (i.e. the molecule)?

Jordan-Wigner
mapping

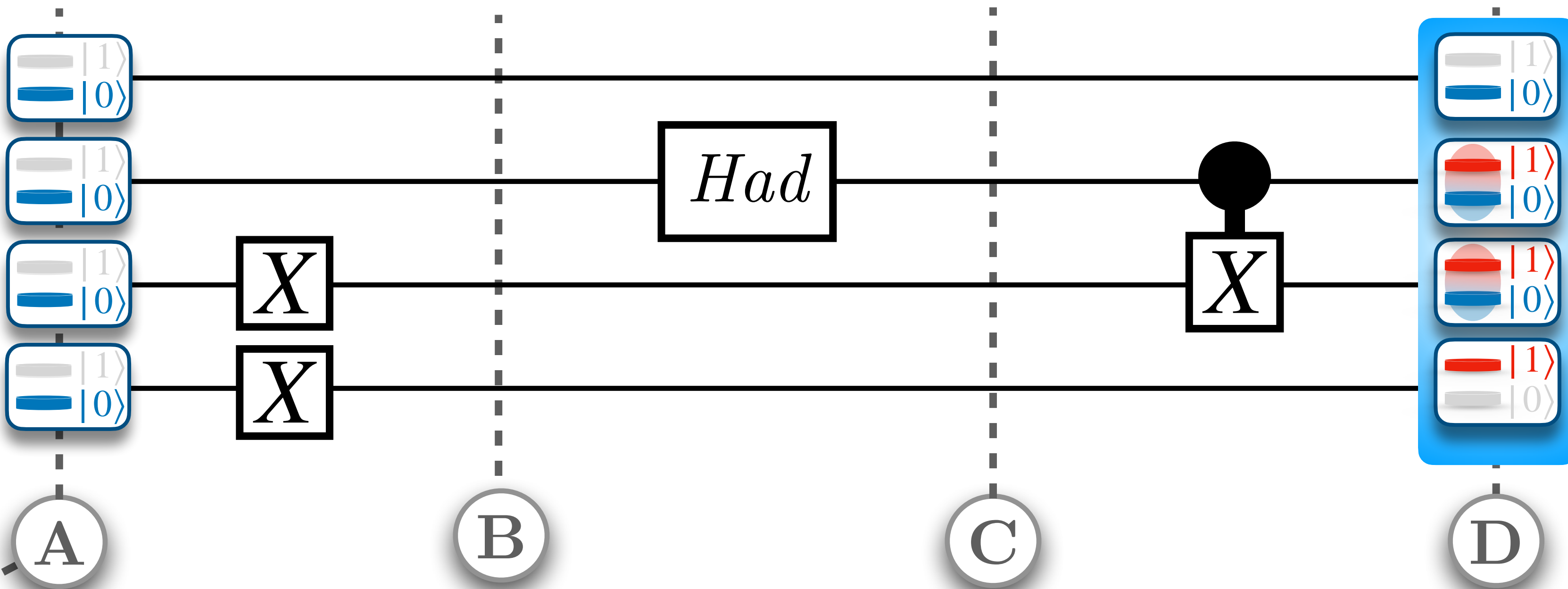
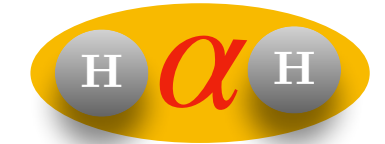
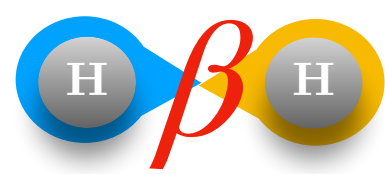

$|\Psi_{Qubits}\rangle?$

$|0000\rangle$

Vacuum

II) Electronic structure on a Quantum Computer

QUESTION

What is the final state of the qubit register (i.e. the molecule)?

Jordan-Wigner mapping

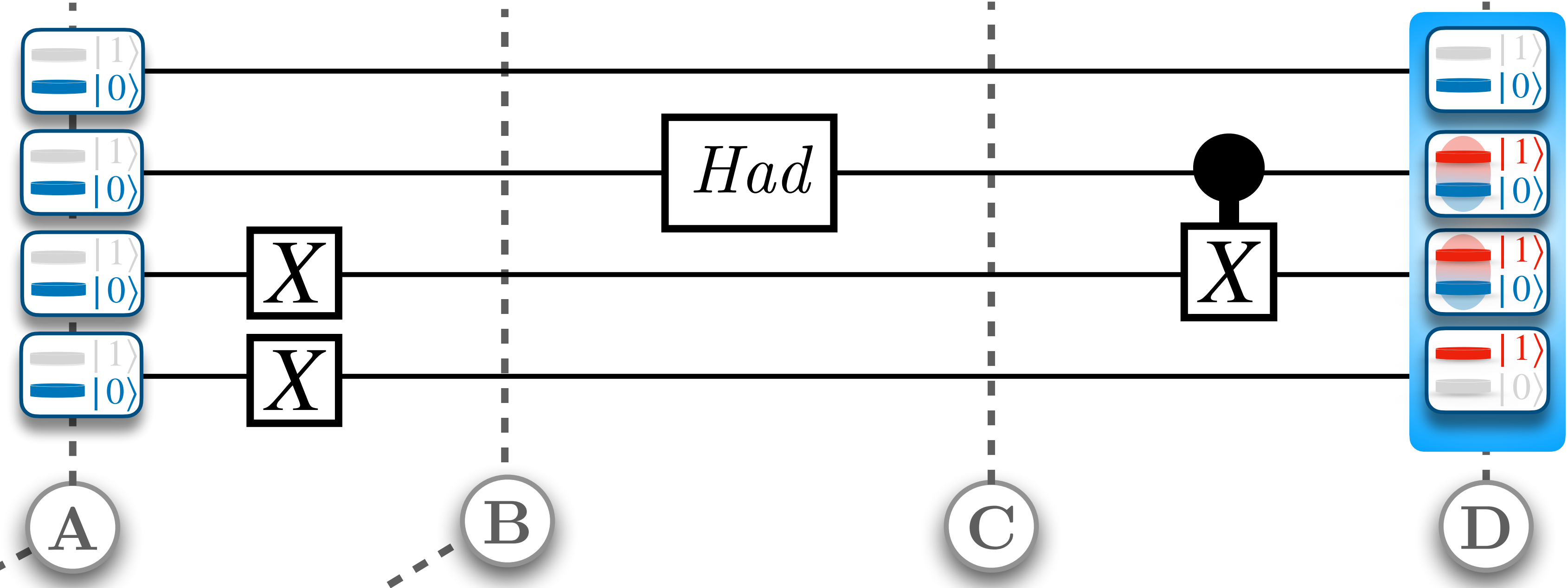
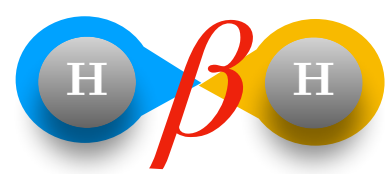

$|\Psi_{Qubits}\rangle?$

$|0000\rangle$

Vacuum

$|1100\rangle$

Hartree-Fock

II) Electronic structure on a Quantum Computer

QUESTION What is the final state of the qubit register (i.e. the molecule)?

Jordan-Wigner mapping

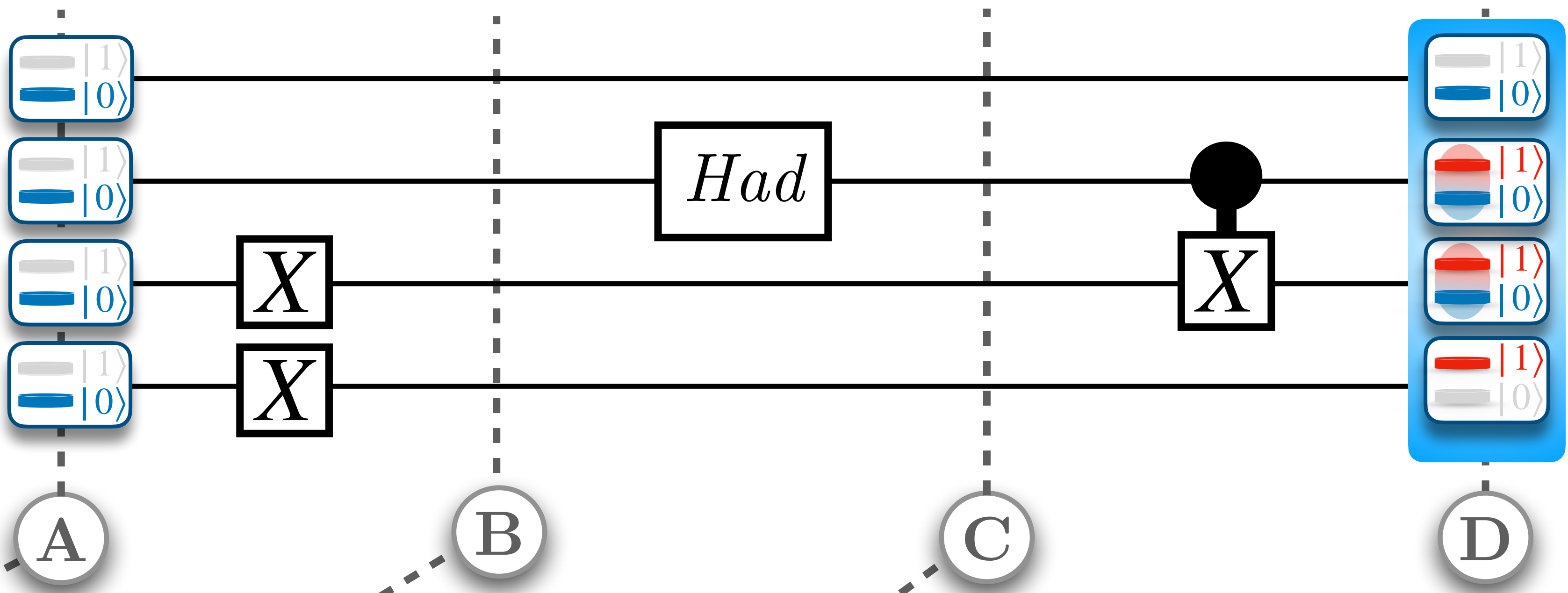
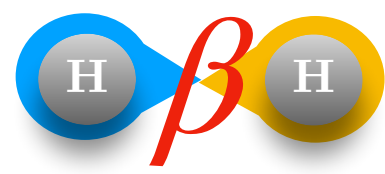

$|\Psi_{Qubits}\rangle?$

$|0000\rangle$

$|1100\rangle$

$\frac{1}{\sqrt{2}}(|1100\rangle + |1110\rangle)$

Vacuum

Hartree-Fock

$H_2 + H_2^-$

II) Electronic structure on a Quantum Computer

QUESTION What is the final state of the qubit register (i.e. the molecule)?

Jordan-Wigner mapping

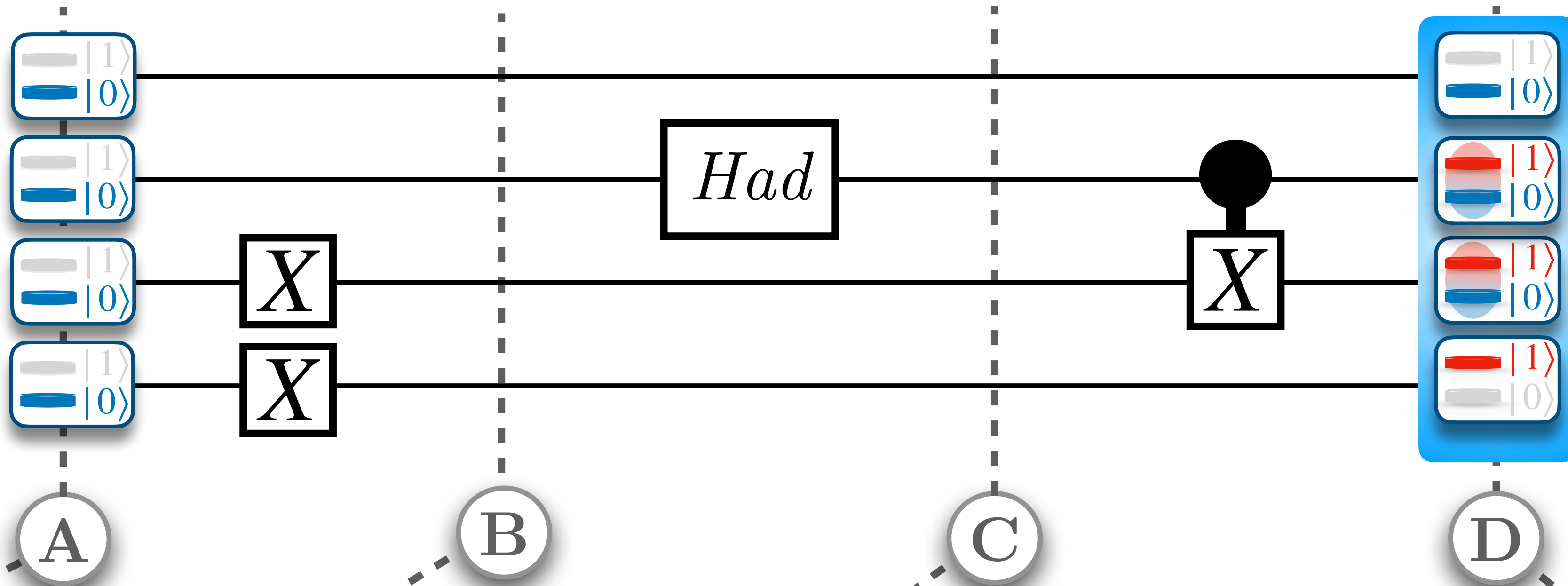
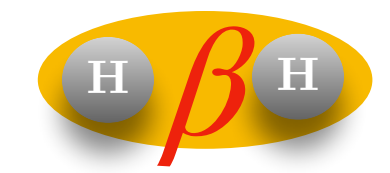

$|\Psi_{Qubits}\rangle?$

$$|0000\rangle$$

Vacuum

$$|1100\rangle$$

Hartree-Fock

$$\frac{1}{\sqrt{2}}(|1100\rangle + |1110\rangle)$$

$H_2 + H_2^-$

$$\frac{1}{\sqrt{2}}(|1100\rangle + |1010\rangle)$$

H_2 (broken symmetry)

II) Electronic structure on a Quantum Computer

QUESTION What is the final state of the qubit register (i.e. the molecule)?

Jordan-Wigner mapping

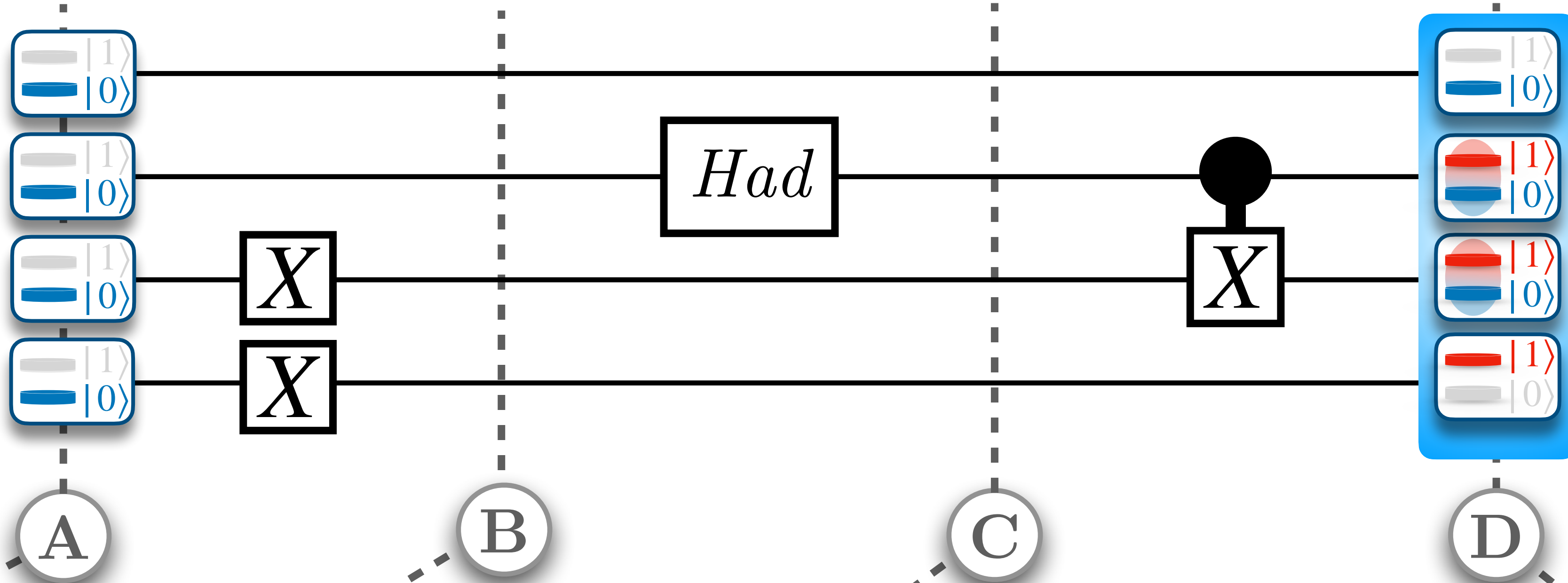
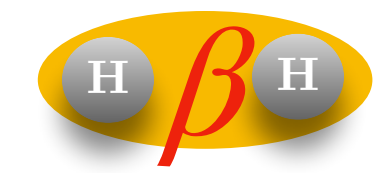

$|\Psi_{Qubits}\rangle?$

$$|0000\rangle$$

Vacuum

$$|1100\rangle$$

Hartree-Fock

$$\frac{1}{\sqrt{2}}(|1100\rangle + |1110\rangle)$$

$H_2 + H_2^-$

$$\frac{1}{\sqrt{2}}(|1100\rangle + |1010\rangle)$$

H_2 (broken symmetry)

QUESTION How to estimate $\langle \hat{n}_0 \rangle = \langle \hat{a}_0^\dagger \hat{a}_0 \rangle?$

II) Electronic structure on a Quantum Computer

QUESTION What is the final state of the qubit register (i.e. the molecule)?

Jordan-Wigner mapping

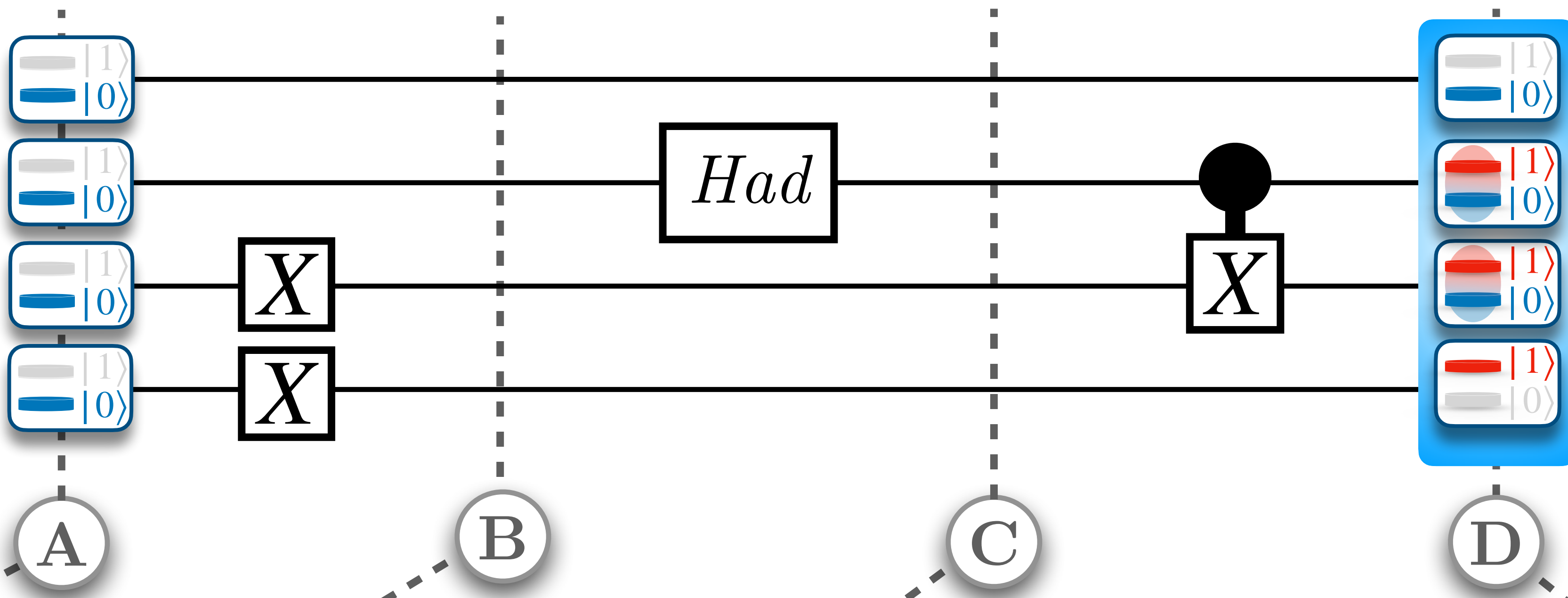
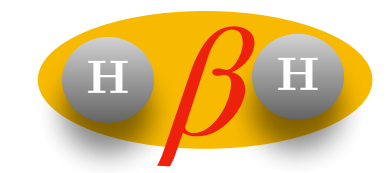

$|\Psi_{Qubits}\rangle?$

$|0000\rangle$

$|1100\rangle$

$\frac{1}{\sqrt{2}}(|1100\rangle + |1110\rangle)$

$\frac{1}{\sqrt{2}}(|1100\rangle + |1010\rangle)$

Vacuum

Hartree-Fock

$H_2 + H_2^-$

H_2 (broken symmetry)

QUESTION How to estimate $\langle \hat{n}_0 \rangle = \langle \hat{a}_0^\dagger \hat{a}_0 \rangle?$

$\langle \hat{a}_0^\dagger \hat{a}_0 \rangle \longrightarrow \frac{1}{2} \langle 1 - Z_0 \rangle = 1$

II) Electronic structure on a Quantum Computer

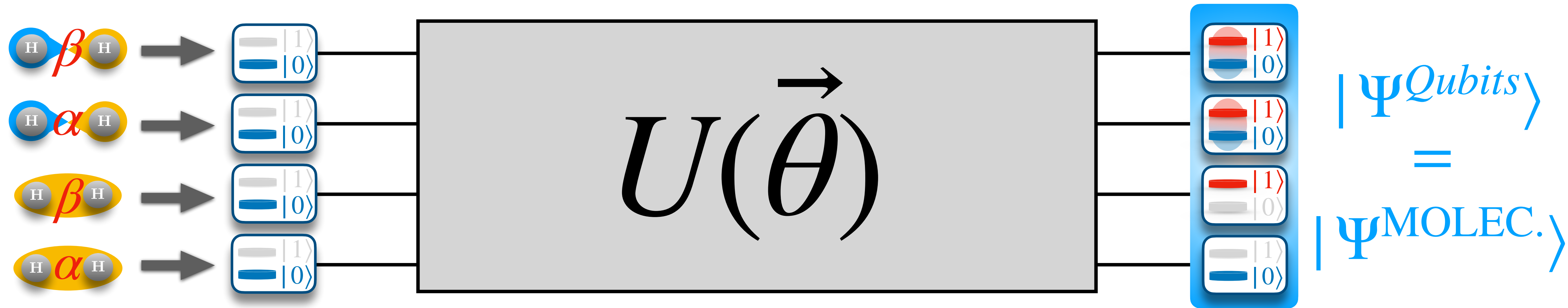

II) Electronic structure on a Quantum Computer

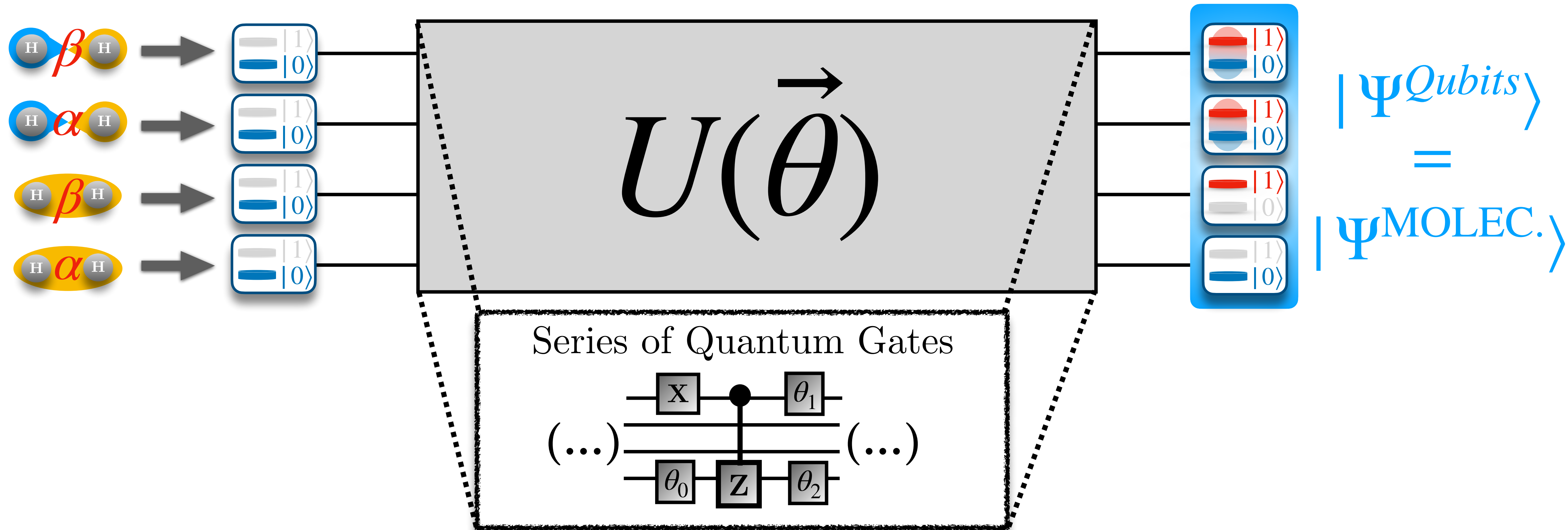

II) Electronic structure on a Quantum Computer

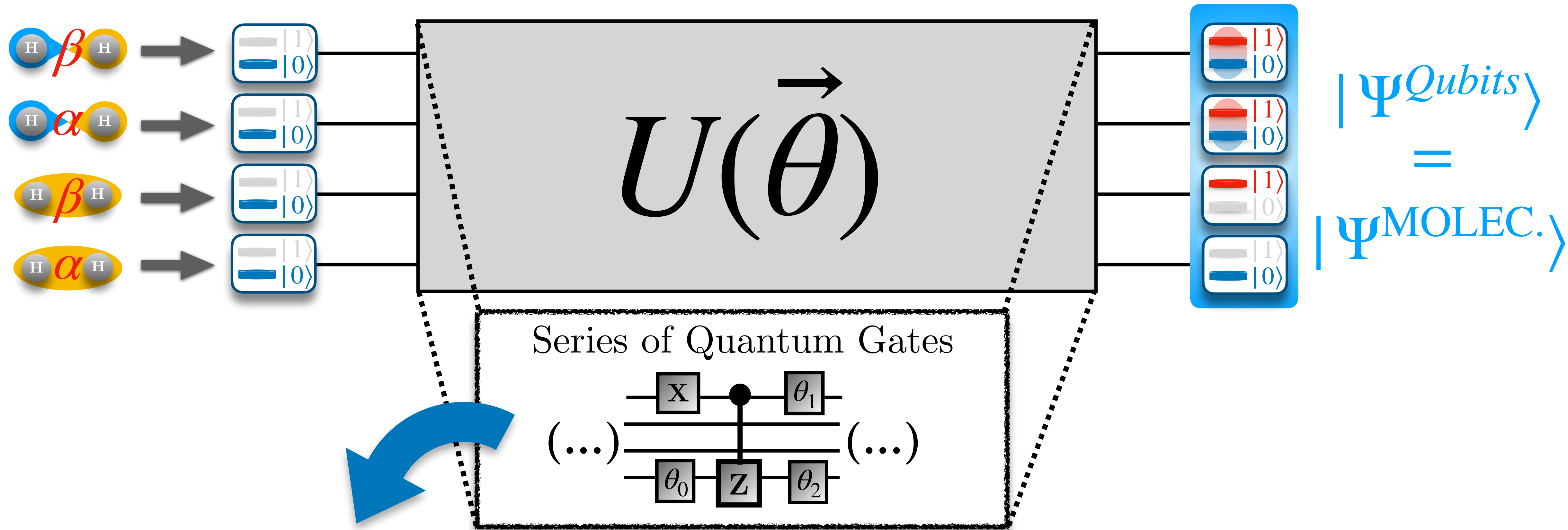

Near Term Era

Hardware Limitations

Variational Quantum Eigensolver

II) Electronic structure on a Quantum Computer

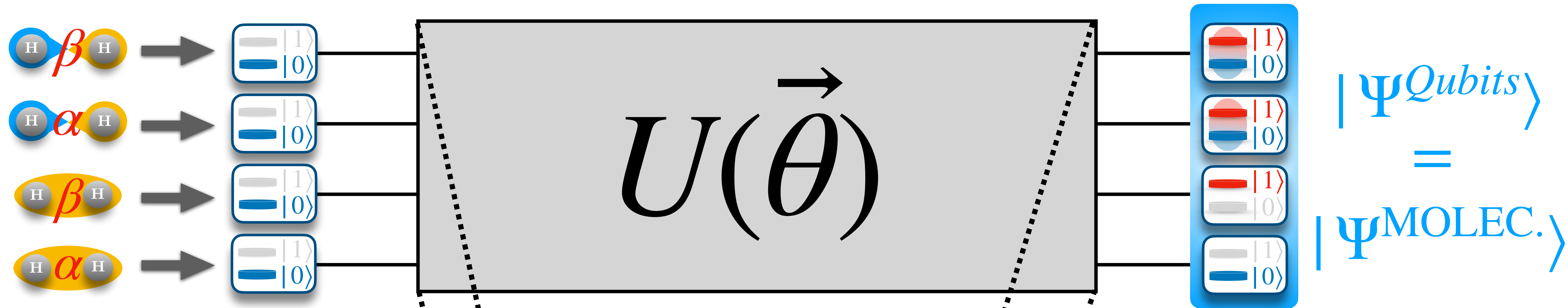

Series of Quantum Gates

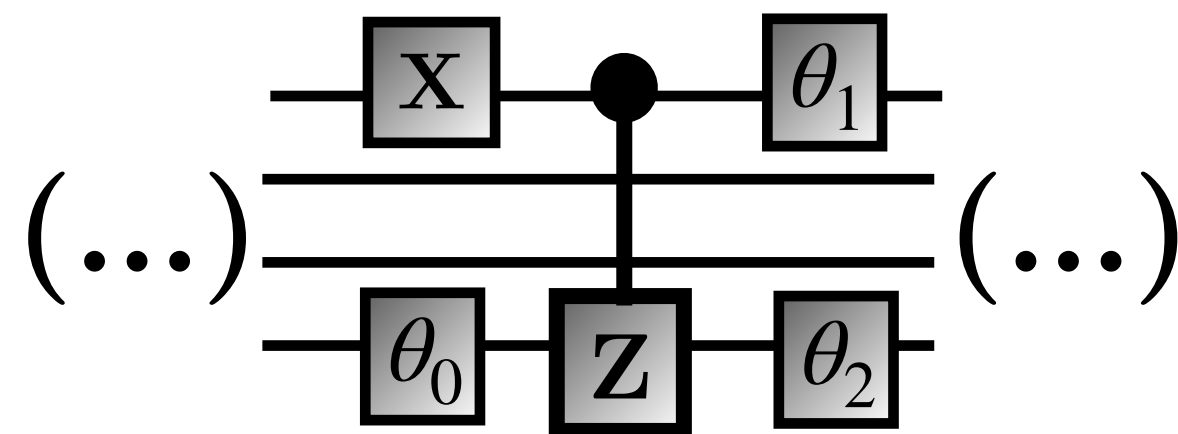

Near Term Era

Hardware Limitations

Variational Quantum Eigensolver

Fault Tolerant Era

No Hardware Limitations

Quantum Phase Estimation

III) Near Term Era:

Variational Quantum Eigensolver

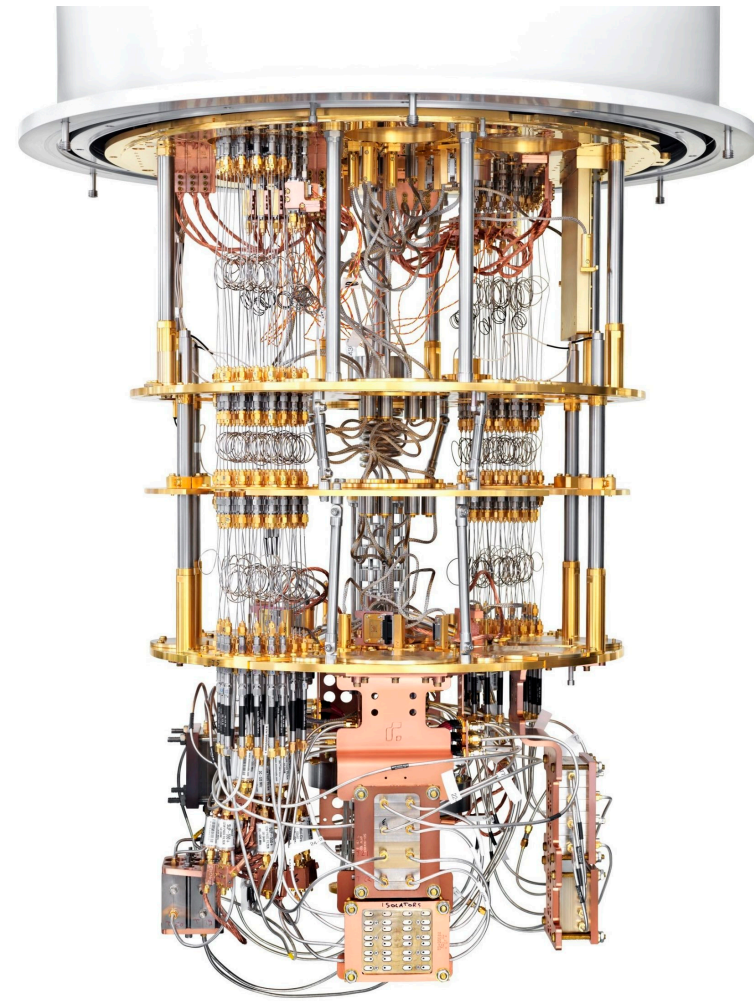

Emerging quantum computers are “NISQ” devices.
(NISQ : Noisy Intermediate-Scale Quantum)

III) Near Term Era: Variational Quantum Eigensolver

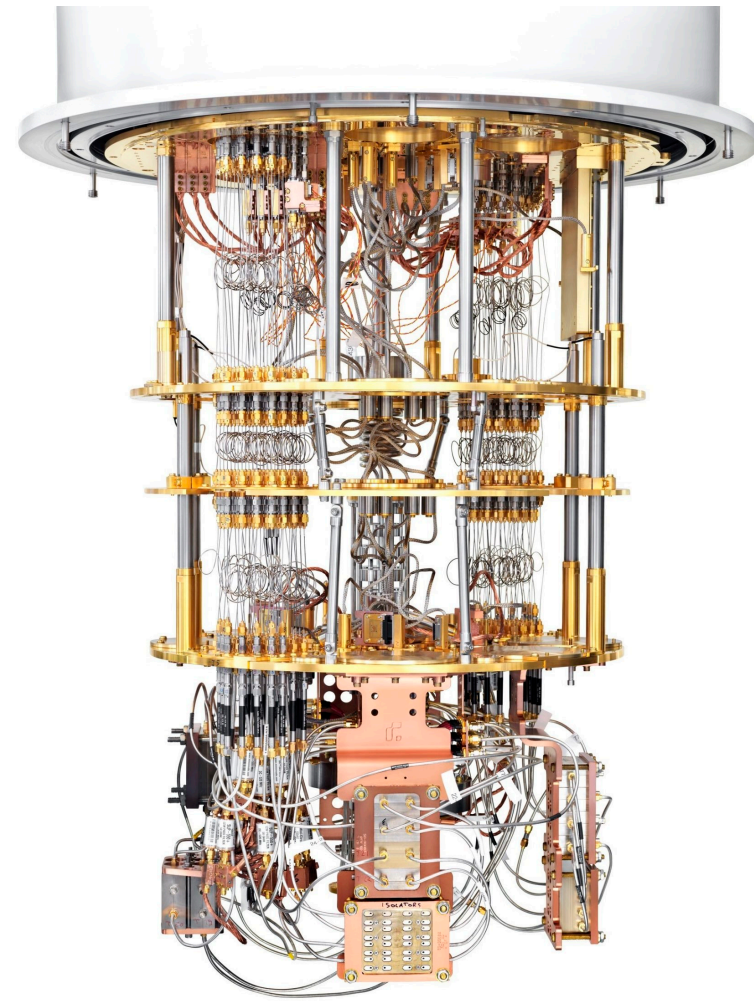

Emerging quantum computers are “NISQ” devices.

(NISQ : **Noisy** Intermediate-Scale Quantum)

Quantum Decoherence
+
Gate Error

III) Near Term Era: Variational Quantum Eigensolver

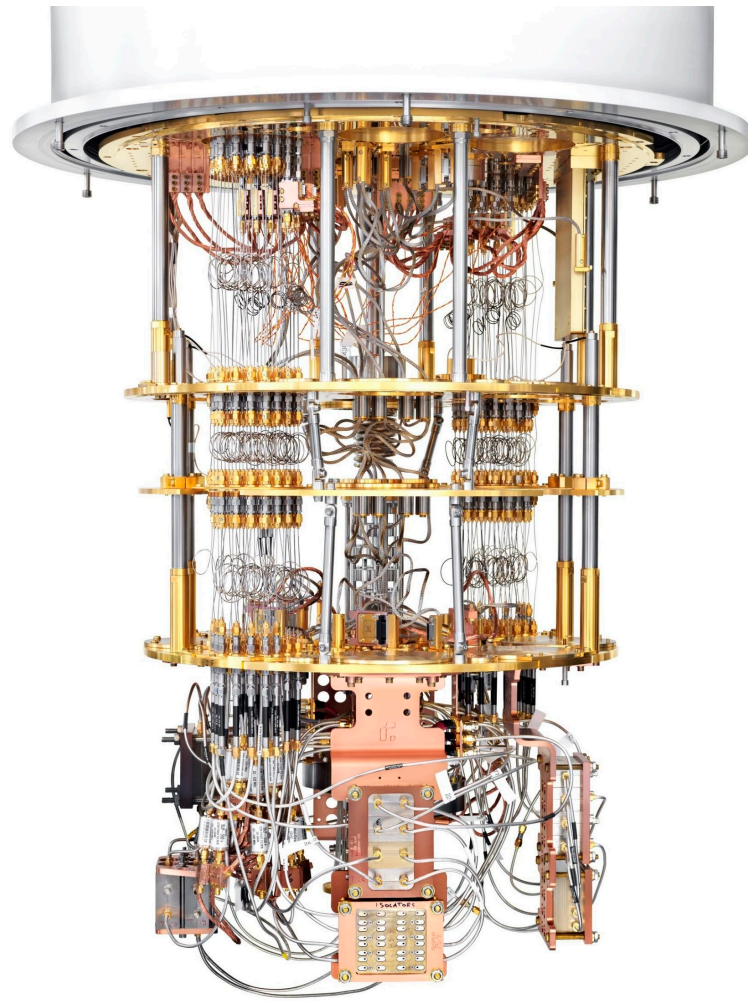

Emerging quantum computers are “NISQ” devices.

(NISQ : **Noisy Intermediate-Scale Quantum**)

Quantum Decoherence
+
Gate Error

Only a few stable qubits accessible

$$N_{qubits} \sim 10$$

III) Near Term Era: Variational Quantum Eigensolver

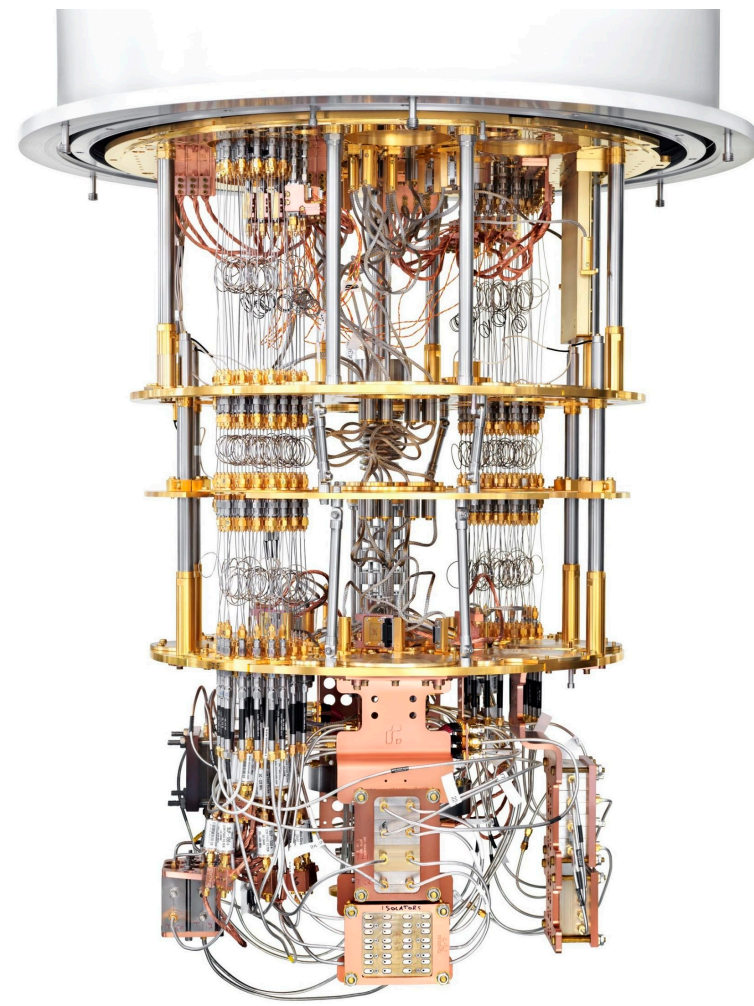

Emerging quantum computers are “NISQ” devices.

(NISQ : **Noisy Intermediate-Scale Quantum**)

Quantum Decoherence
+
Gate Error

Only a few stable qubits accessible

$$N_{qubits} \sim 10$$

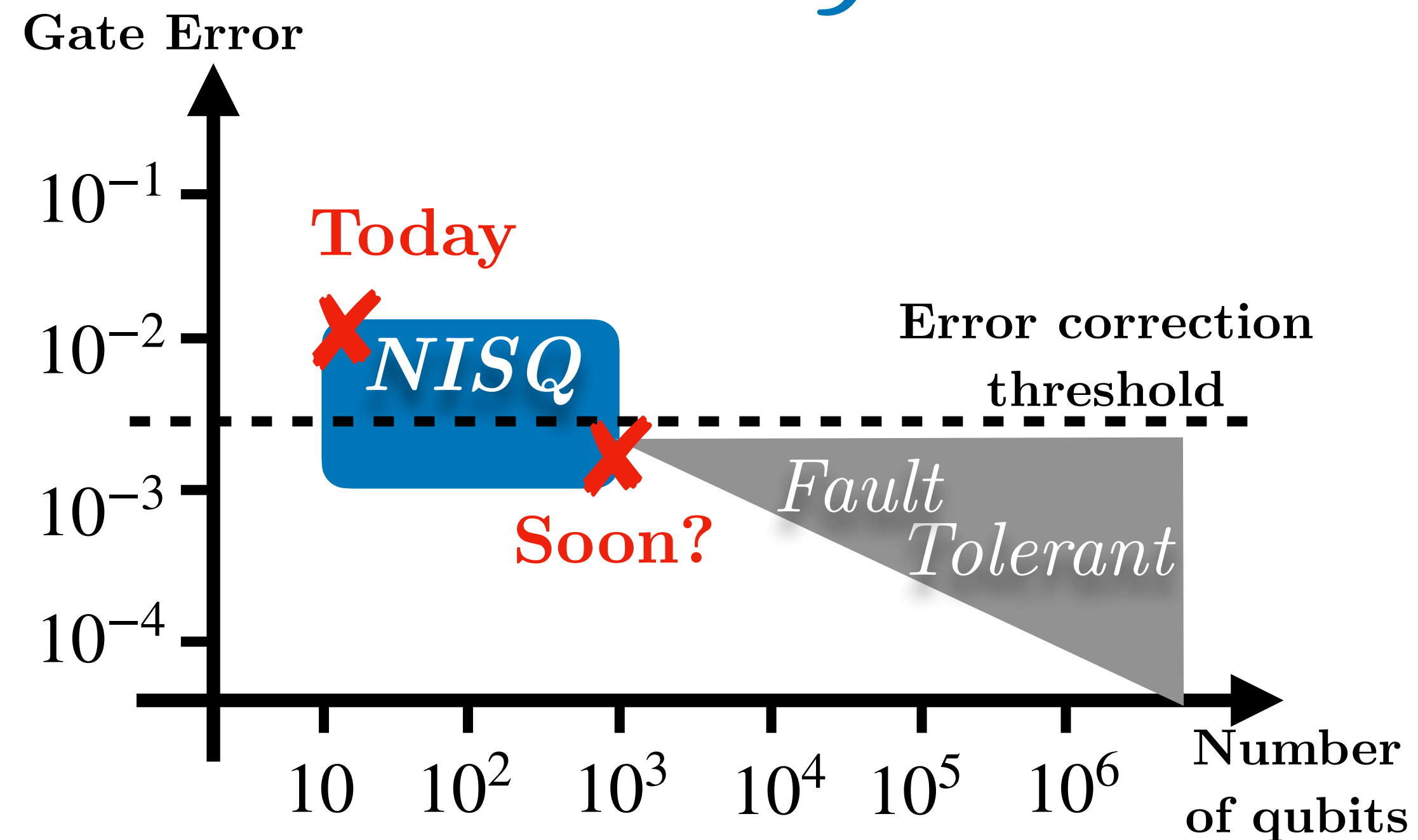

III) Near Term Era: Variational Quantum Eigensolver

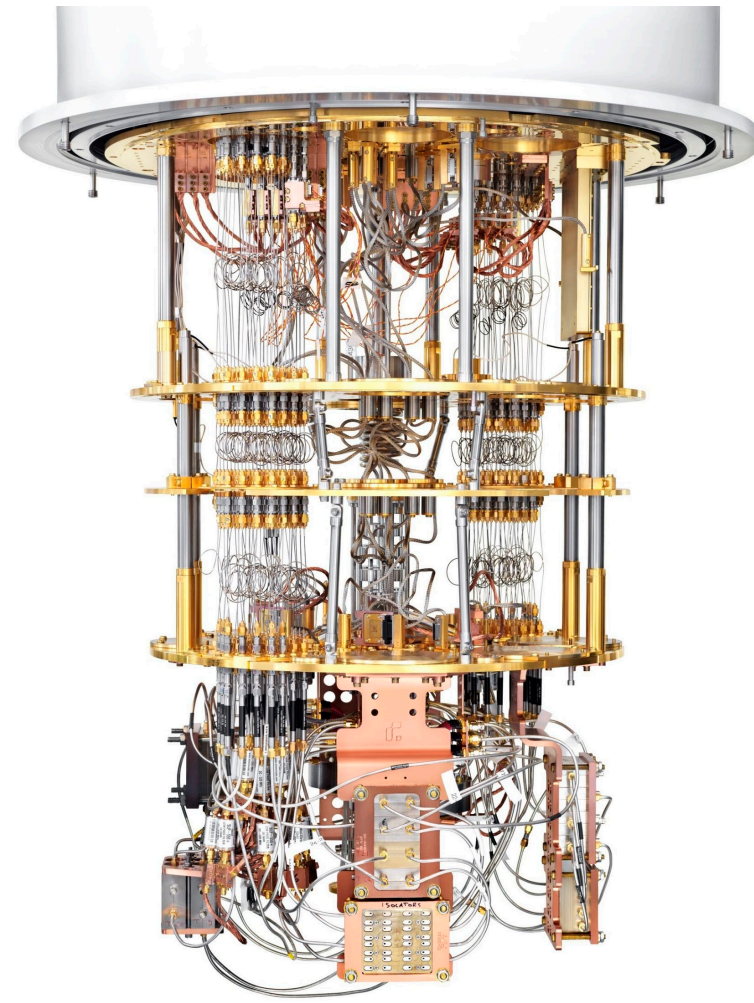

Emerging quantum computers are “NISQ” devices.

(NISQ : **Noisy Intermediate-Scale Quantum**)

Quantum Decoherence
+
Gate Error

Only a few stable qubits accessible

$$N_{qubits} \sim 10$$

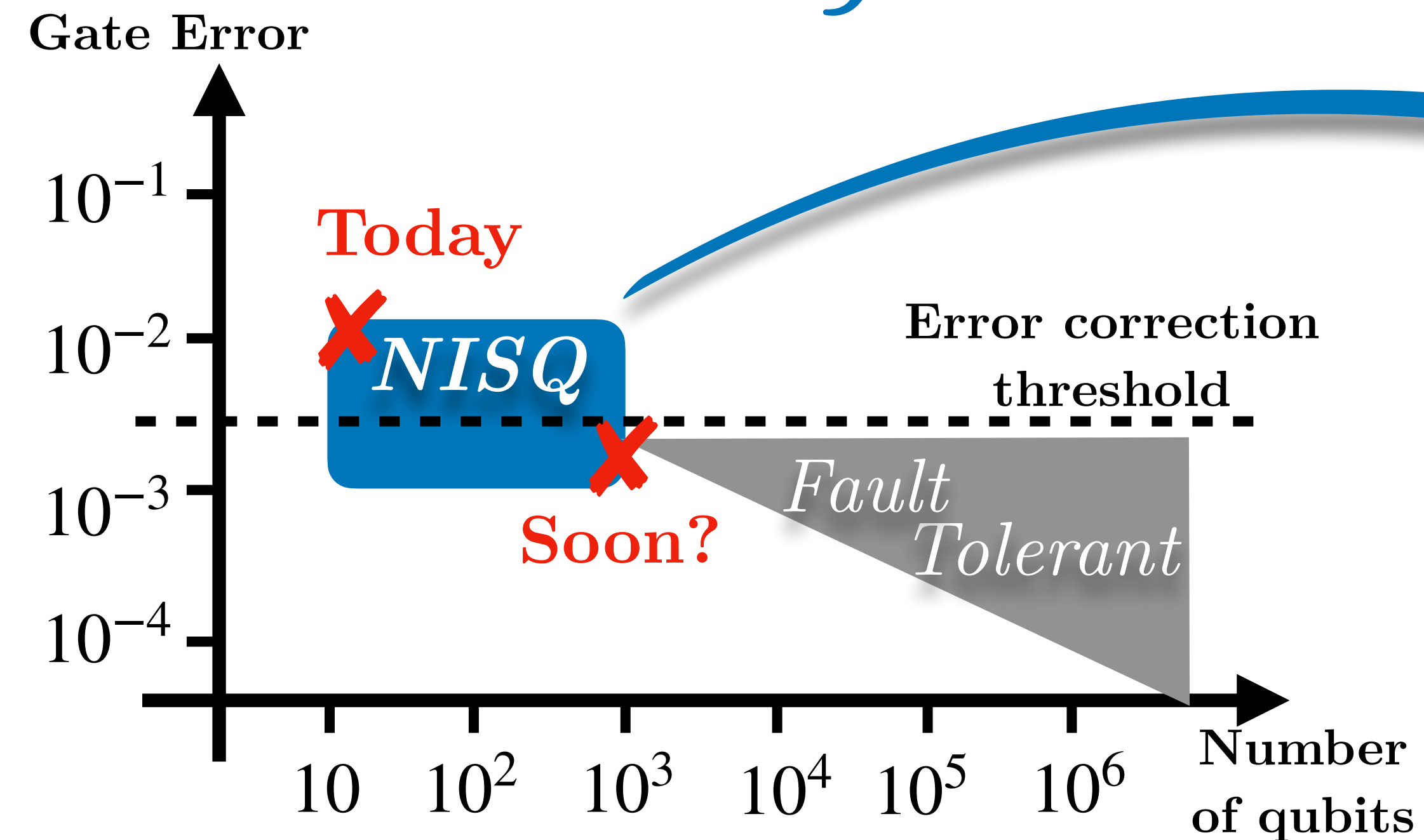

NISQ algorithms

- Based on a few qubits and quantum gates.
- Pretty resistant to the noise effects.
- *Exponentially* fewer resources to store information

VQE: Variational Quantum Eigensolver

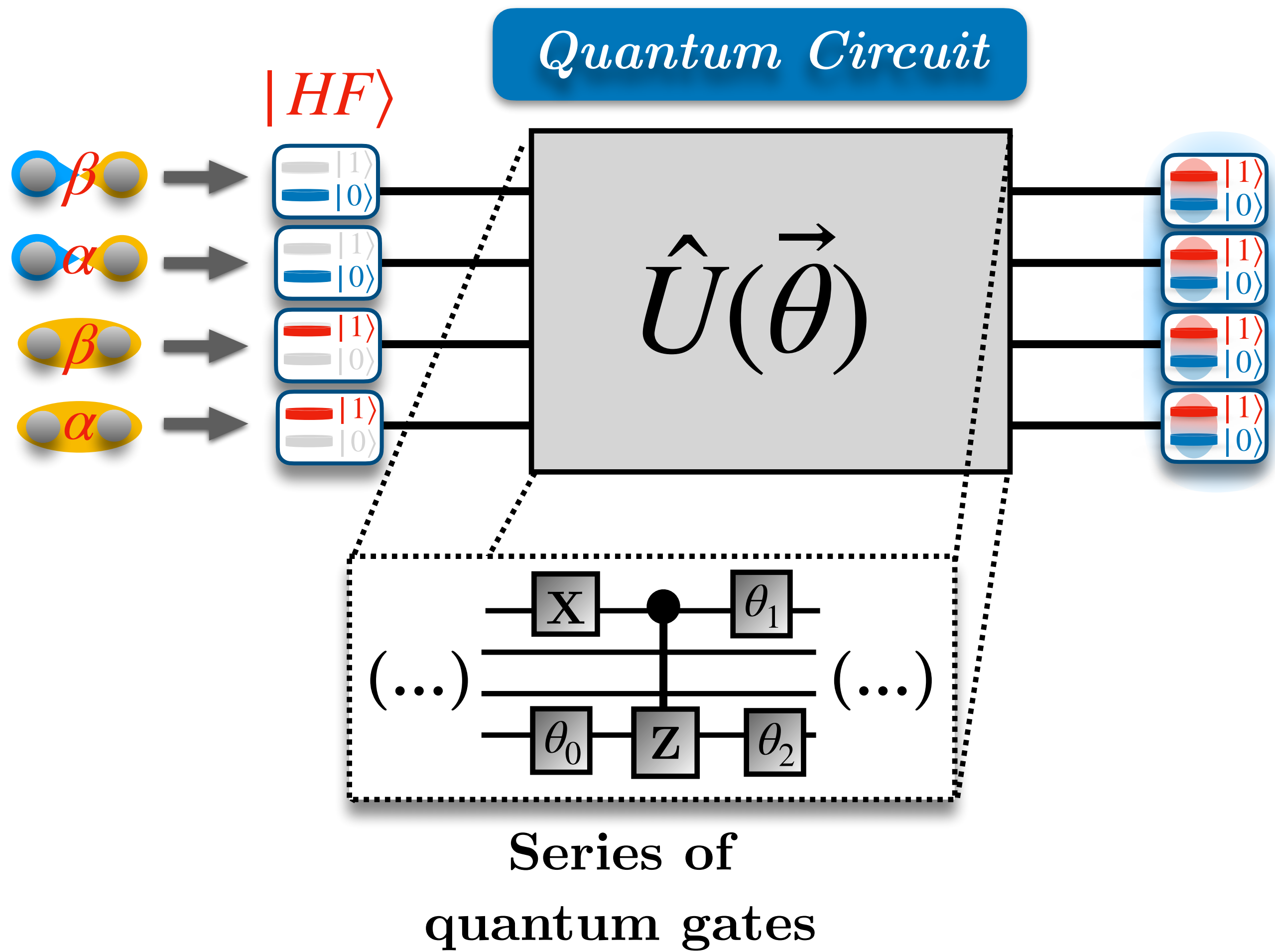

VQE: Variational Quantum Eigensolver

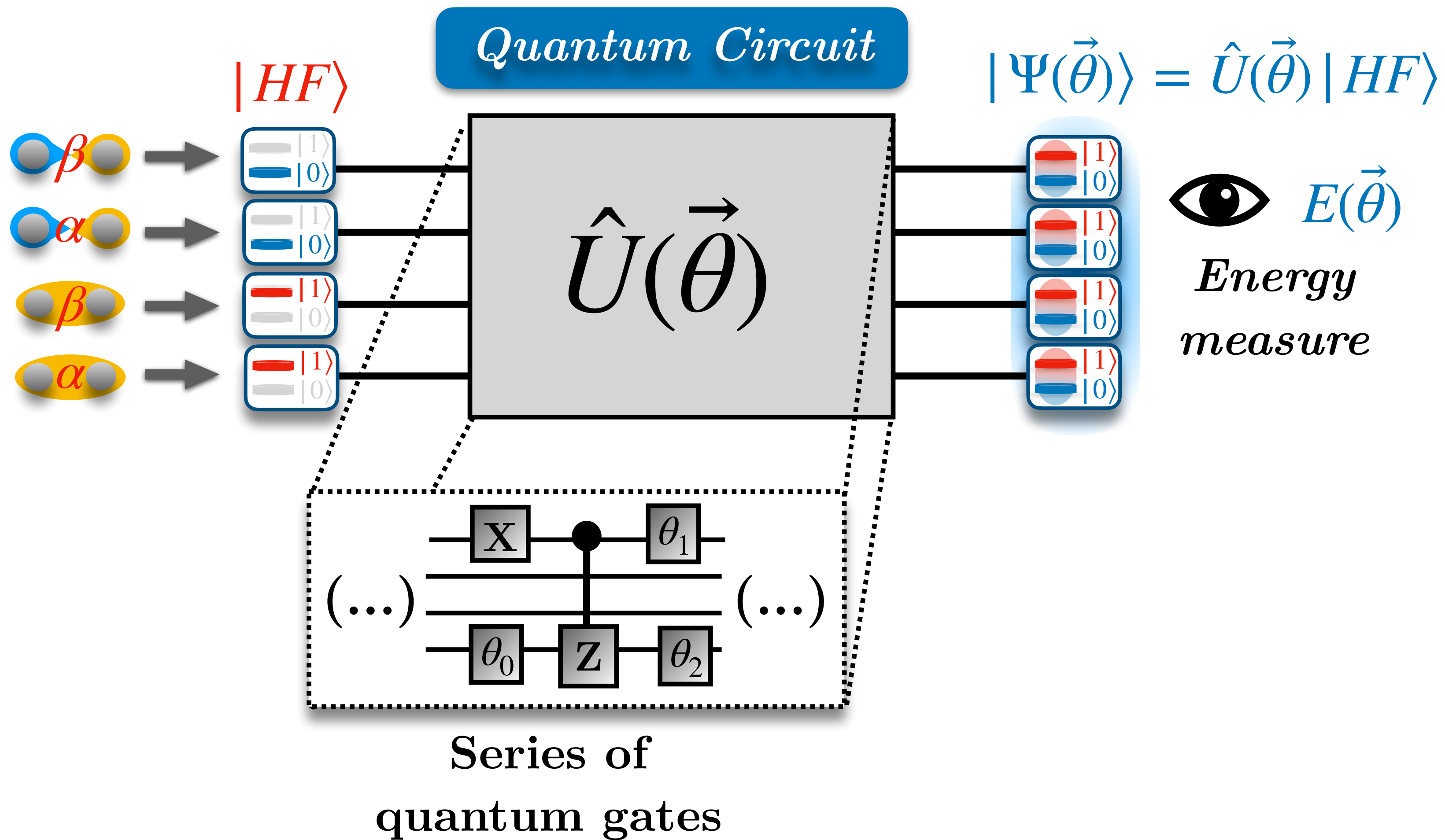

VQE: Variational Quantum Eigensolver

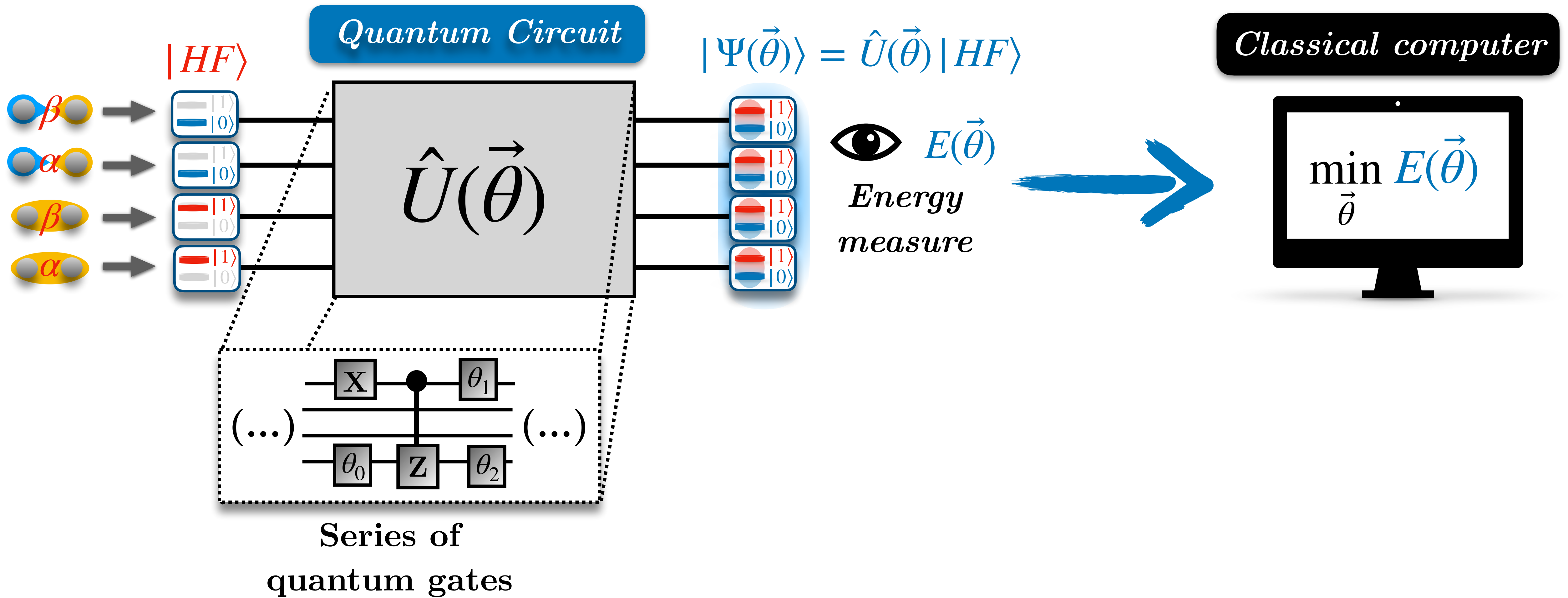

III) Near Term Era: Variational Quantum Eigensolver

VQE: Variational Quantum Eigensolver

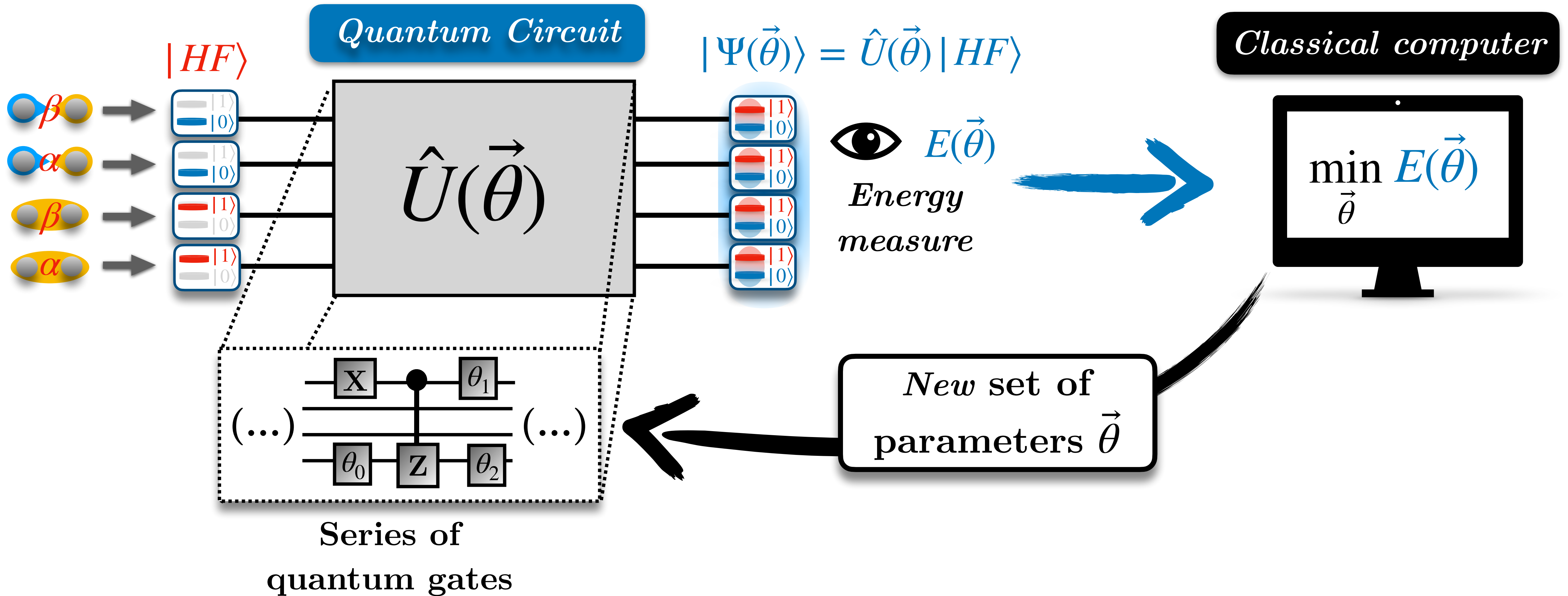

III) Near Term Era: Variational Quantum Eigensolver

VQE: Variational Quantum Eigensolver

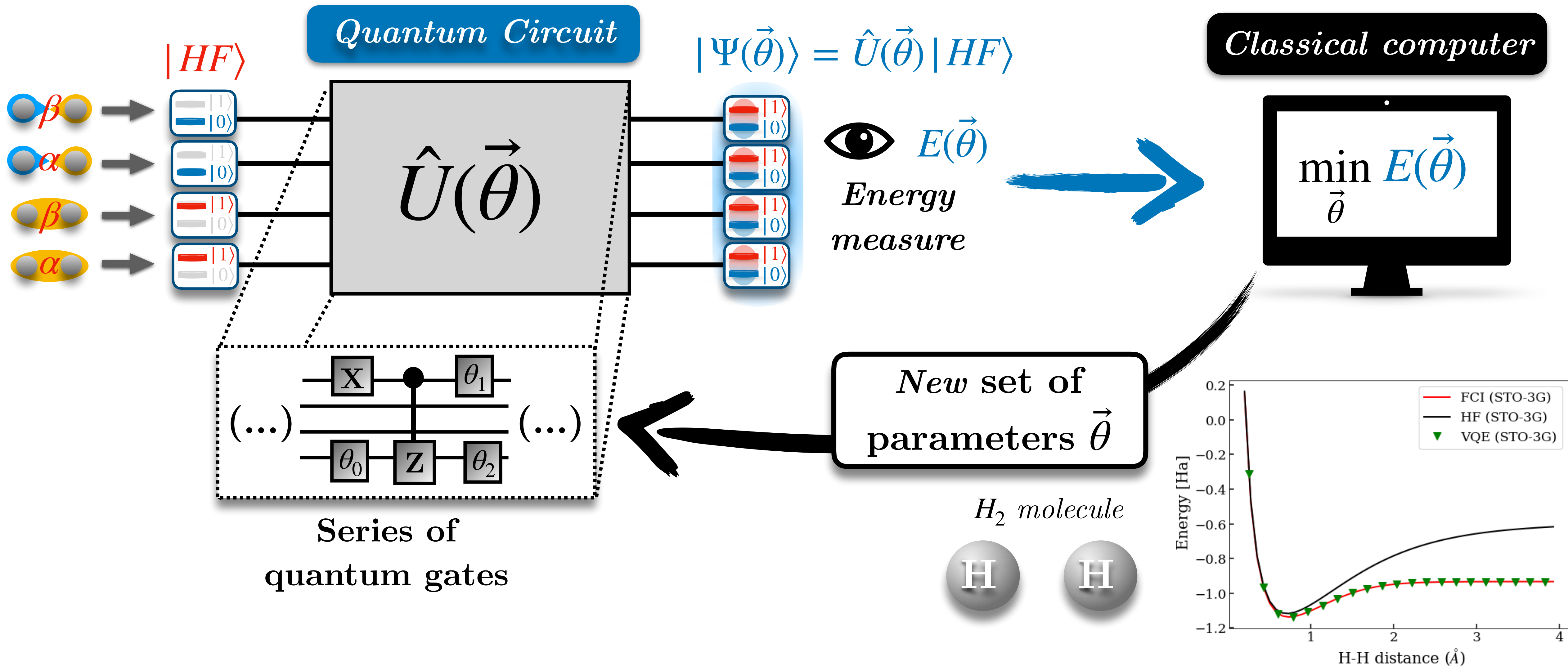

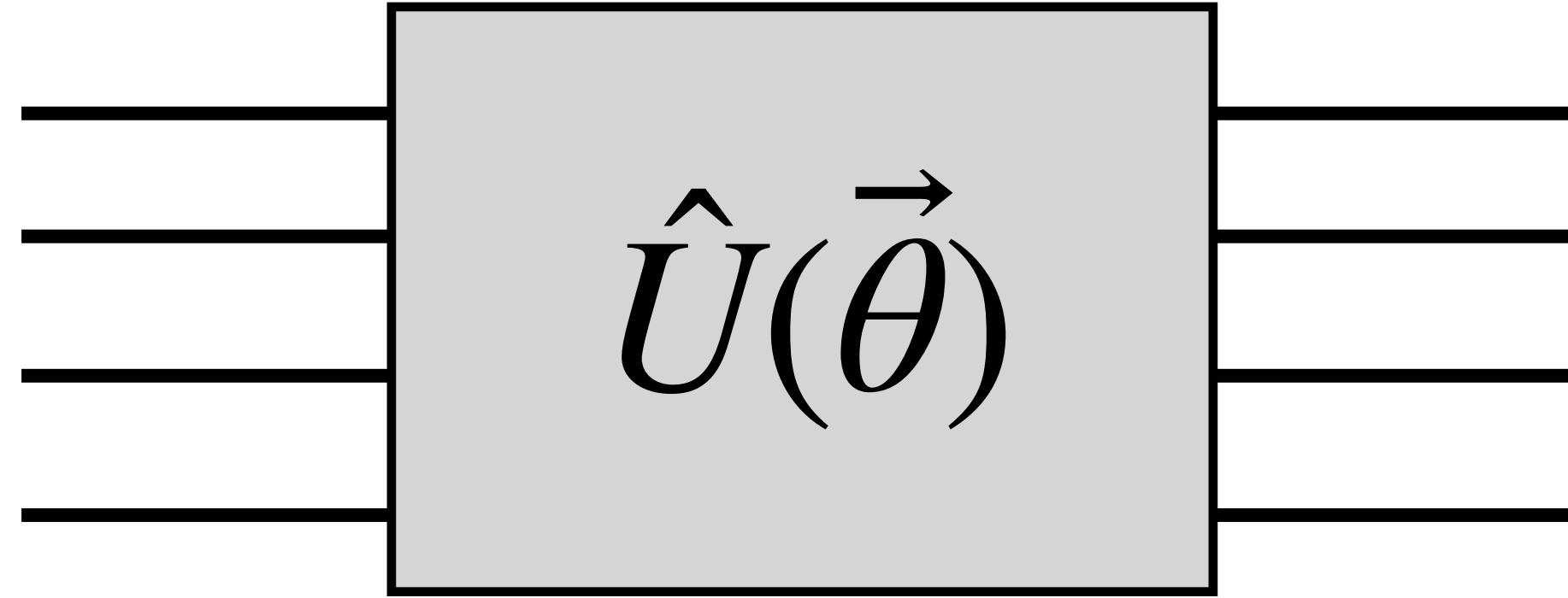

*Which ansatze ?
How do we build them ?*

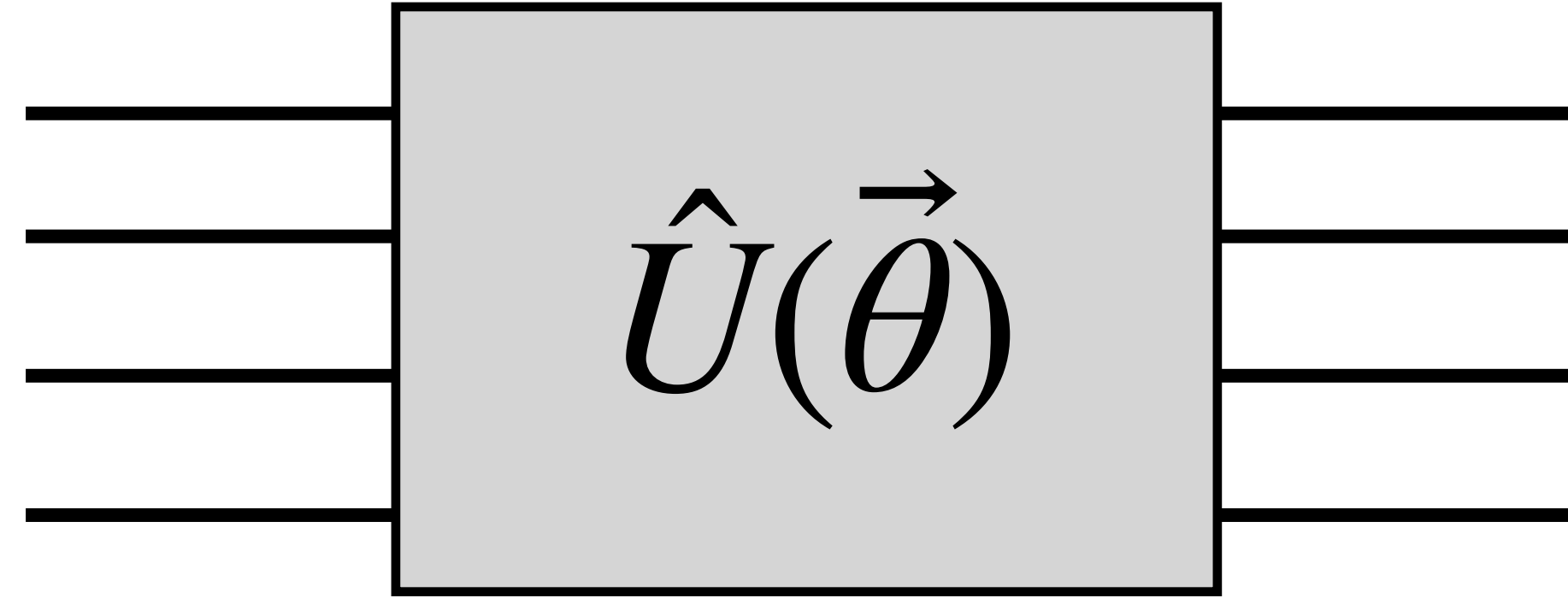

*Which ansatzes ?
How do we build them ?*

Hardware-efficient ansatz

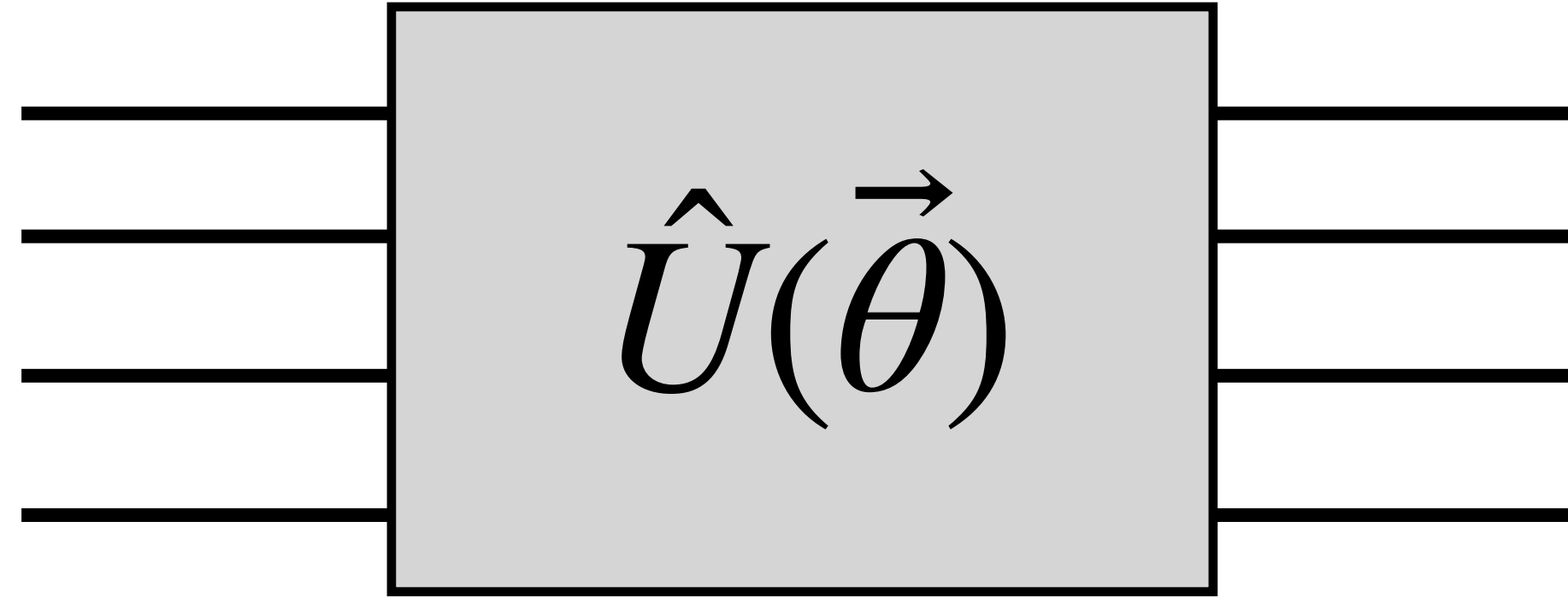

*Which ansatzes ?
How do we build them ?*

Hardware-efficient ansatz

Unitary Coupled Cluster ansatz

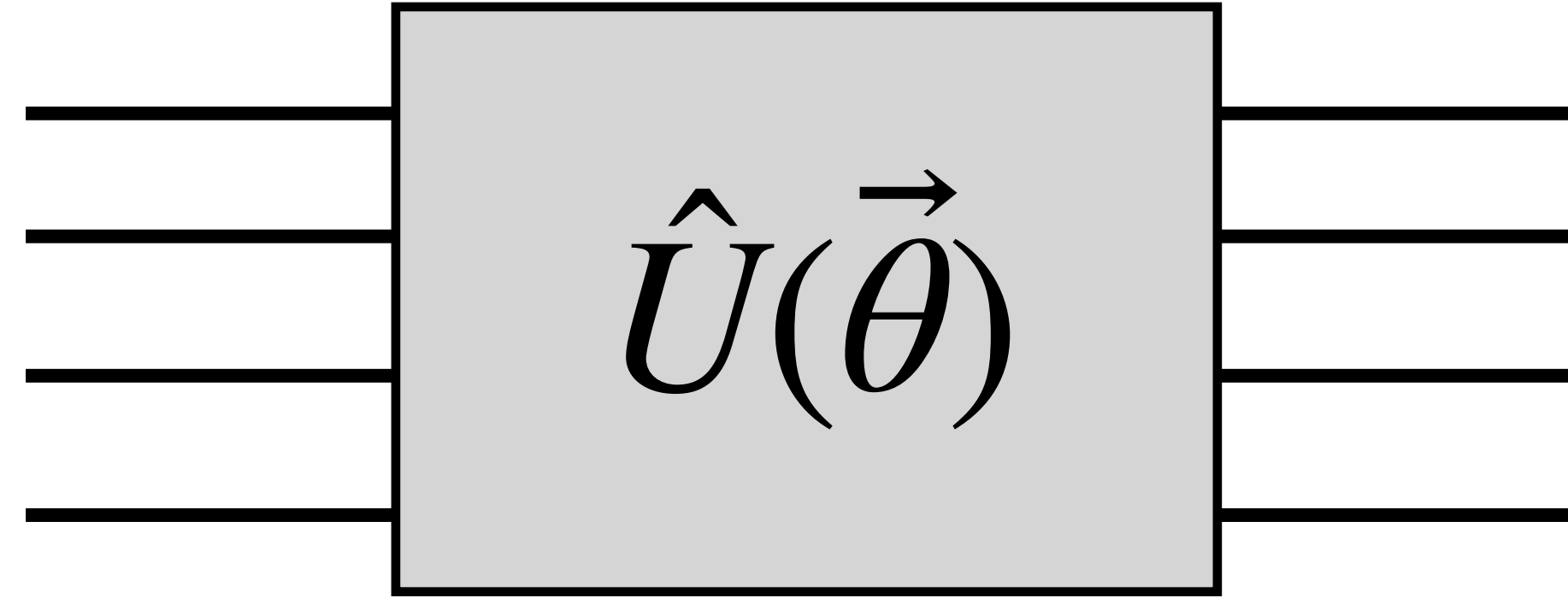

*Which ansatzes ?
How do we build them ?*

Hardware-efficient ansatz

Unitary Coupled Cluster ansatz

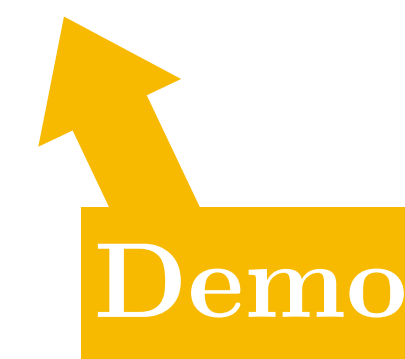

III) Near Term Era: Variational Quantum Eigensolver

Hardware-efficient ansatz

Kandala, Abhinav, et al. "Hardware-efficient variational quantum eigensolver for small molecules and quantum magnets." *Nature* 549.7671 (2017): 242-246.

III) Near Term Era: Variational Quantum Eigensolver

Hardware-efficient ansatz

Kandala, Abhinav, et al. "Hardware-efficient variational quantum eigensolver for small molecules and quantum magnets." *Nature* 549.7671 (2017): 242-246.

1) Start from a set of gates

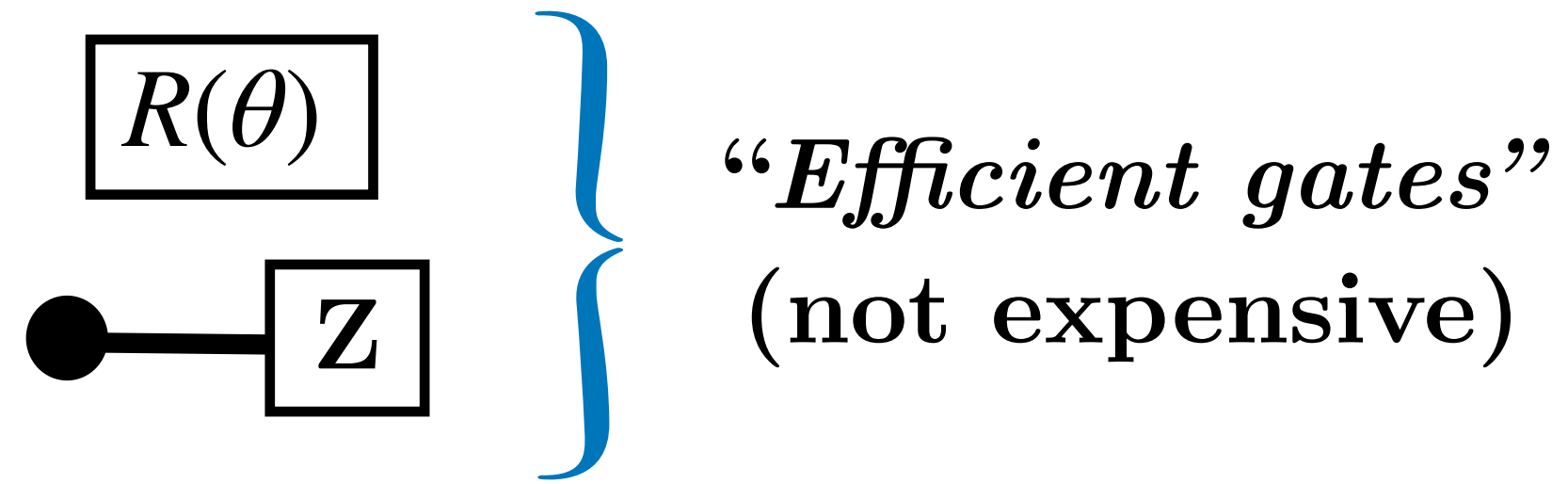

III) Near Term Era: Variational Quantum Eigensolver

Hardware-efficient ansatz

Kandala, Abhinav, et al. "Hardware-efficient variational quantum eigensolver for small molecules and quantum magnets." *Nature* 549.7671 (2017): 242-246.

1) Start from a set of gates



2) Create a fragment of circuit

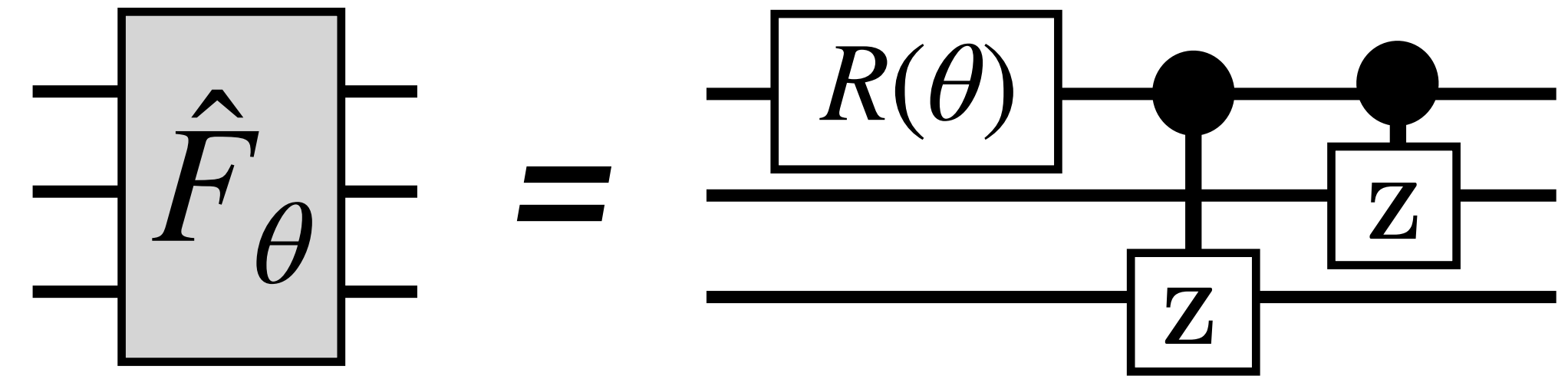

III) Near Term Era: Variational Quantum Eigensolver

Hardware-efficient ansatz

Kandala, Abhinav, et al. "Hardware-efficient variational quantum eigensolver for small molecules and quantum magnets." *Nature* 549.7671 (2017): 242-246.

1) Start from a set of gates

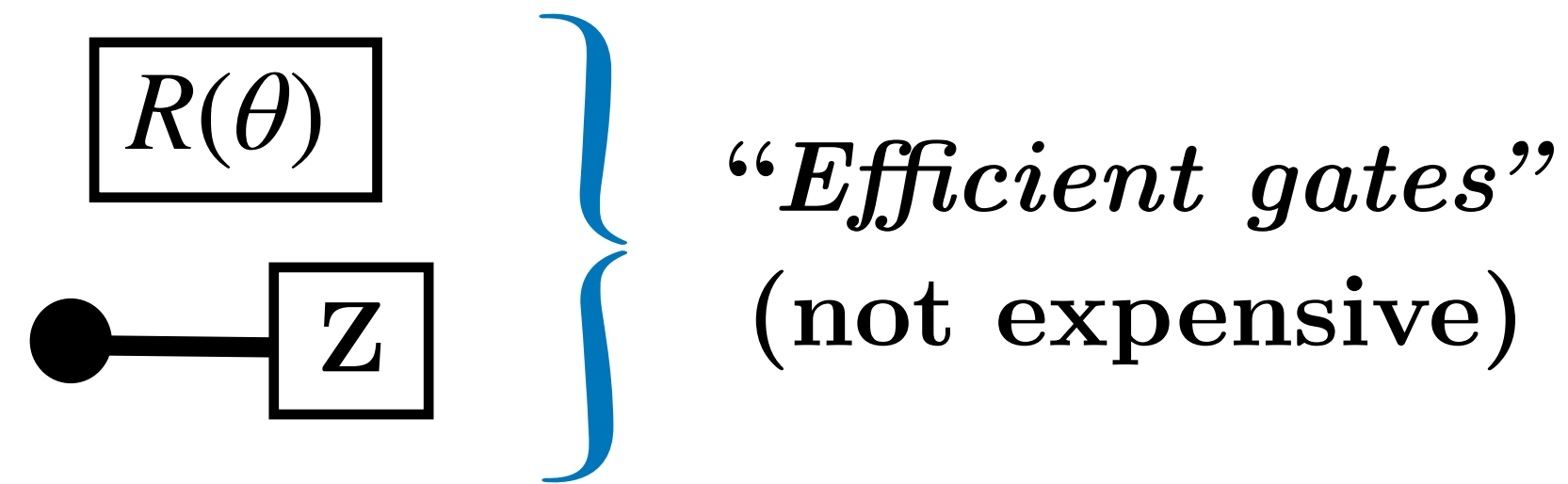

2) Create a fragment of circuit

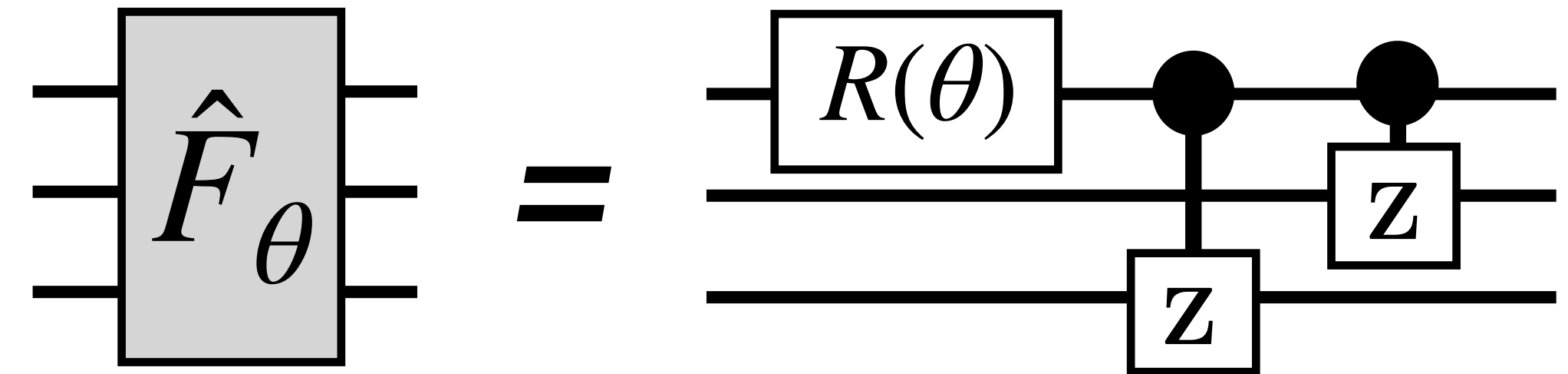

3) Build a circuit including several fragments

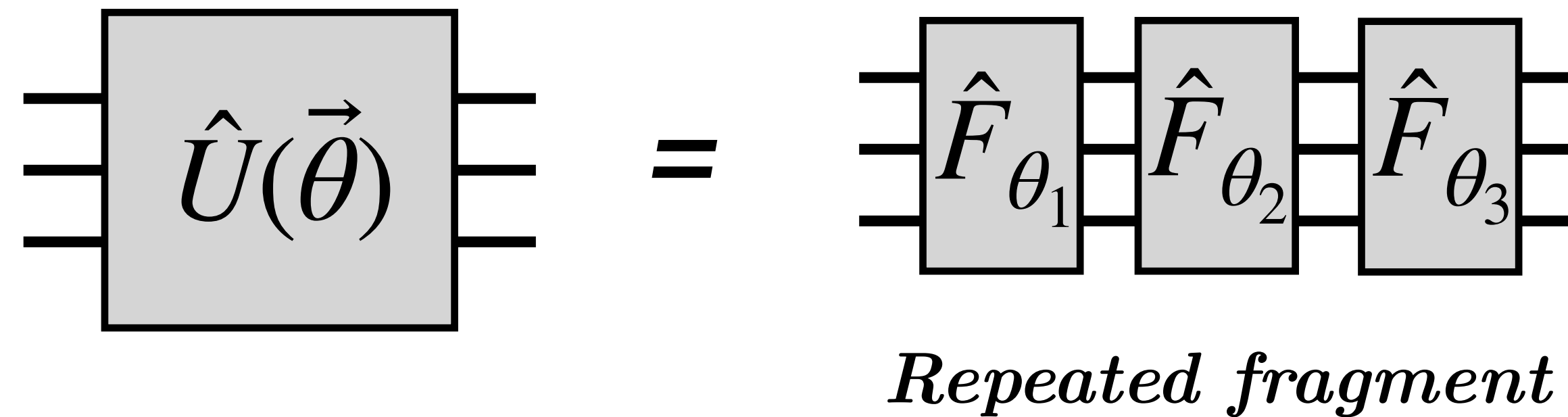

III) Near Term Era: Variational Quantum Eigensolver

Hardware-efficient ansatz

Kandala, Abhinav, et al. "Hardware-efficient variational quantum eigensolver for small molecules and quantum magnets." *Nature* 549.7671 (2017): 242-246.

1) Start from a set of gates

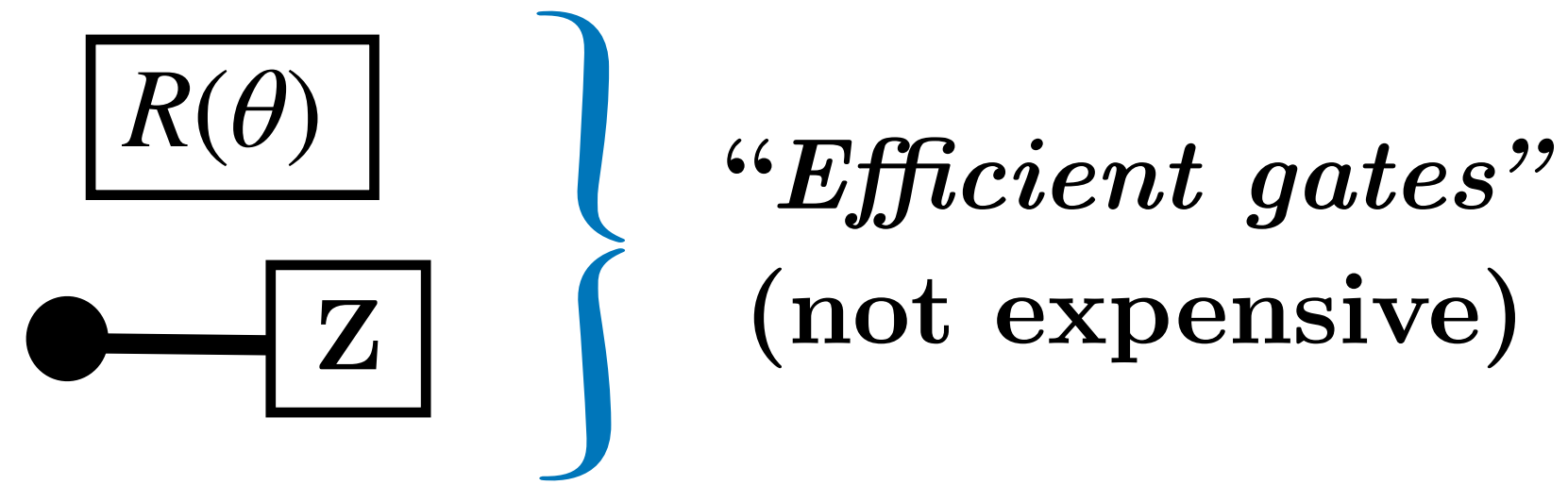

2) Create a fragment of circuit

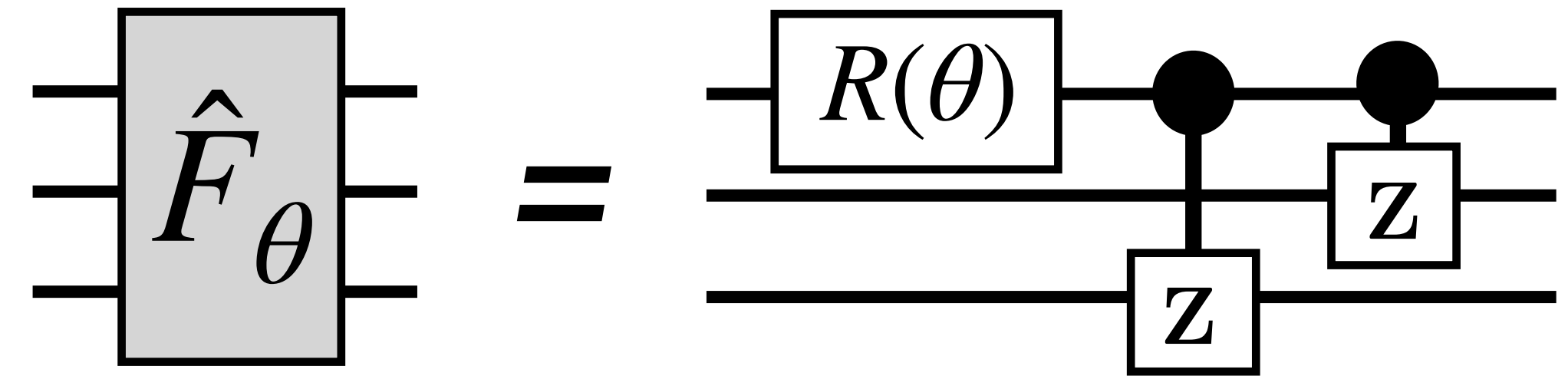

3) Build a circuit including several fragments

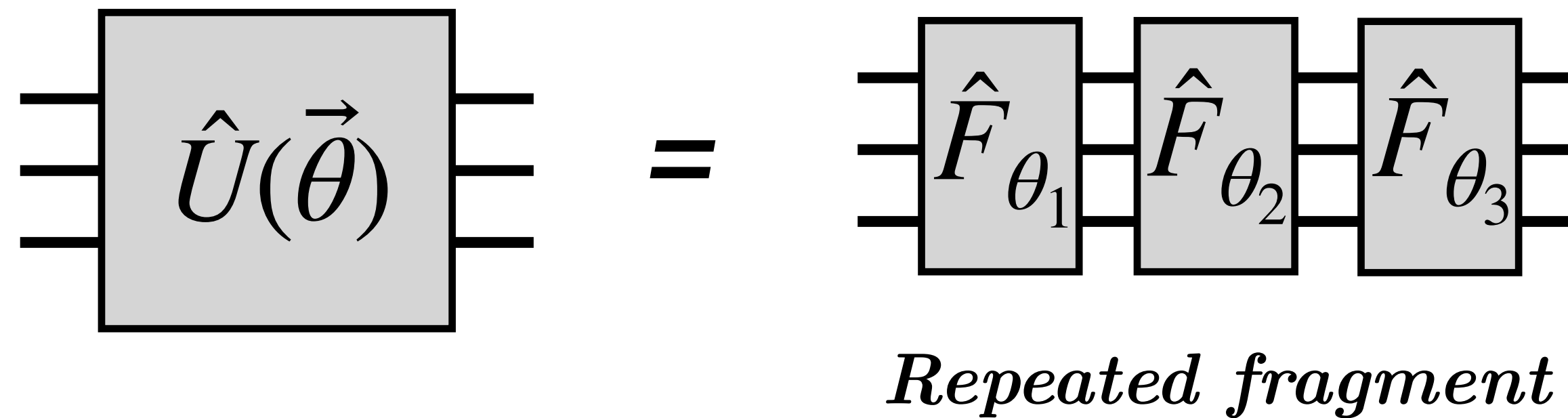

- ✓ Not expensive
- ✓ ✗ May break symmetries
- ✗ Optimisation seems hard

III) Near Term Era: Variational Quantum Eigensolver

Unitary Coupled Cluster ansatz

Romero, Jonathan, et al. "Strategies for quantum computing molecular energies using the unitary coupled cluster ansatz." *Quantum Science and Technology* 4.1 (2018): 014008.

Unitary Coupled Cluster ansatz

Romero, Jonathan, et al. "Strategies for quantum computing molecular energies using the unitary coupled cluster ansatz." *Quantum Science and Technology* 4.1 (2018): 014008.

1) Start from an excitation operator

$$\hat{T}(\vec{\theta}) = \sum_l^{\text{exc. op.}} \theta_l \hat{\tau}_l$$

III) Near Term Era: Variational Quantum Eigensolver

Unitary Coupled Cluster ansatz

Romero, Jonathan, et al. "Strategies for quantum computing molecular energies using the unitary coupled cluster ansatz." *Quantum Science and Technology* 4.1 (2018): 014008.

1) Start from an excitation operator

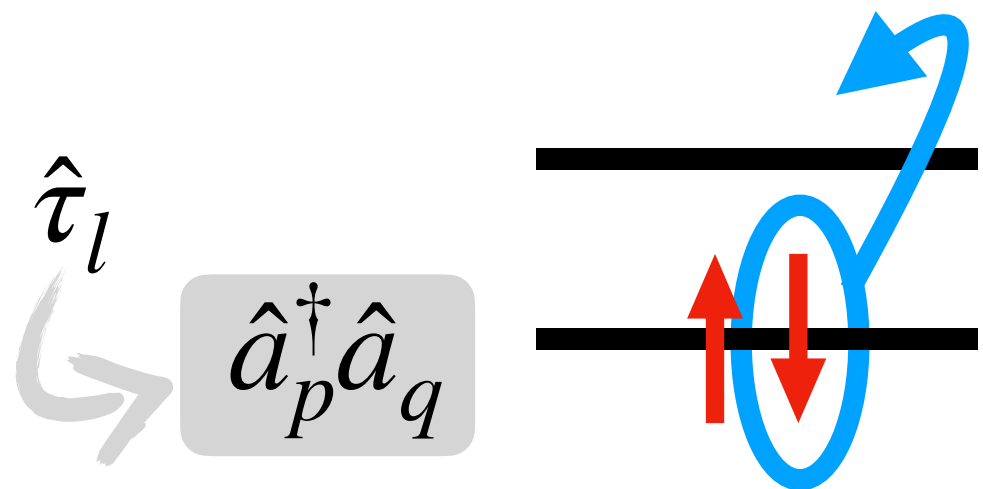
$$\hat{T}(\vec{\theta}) = \sum_l^{\text{exc. op.}} \theta_l \hat{\tau}_l$$

III) Near Term Era: Variational Quantum Eigensolver

Unitary Coupled Cluster ansatz

Romero, Jonathan, et al. "Strategies for quantum computing molecular energies using the unitary coupled cluster ansatz." *Quantum Science and Technology* 4.1 (2018): 014008.

1) Start from an excitation operator

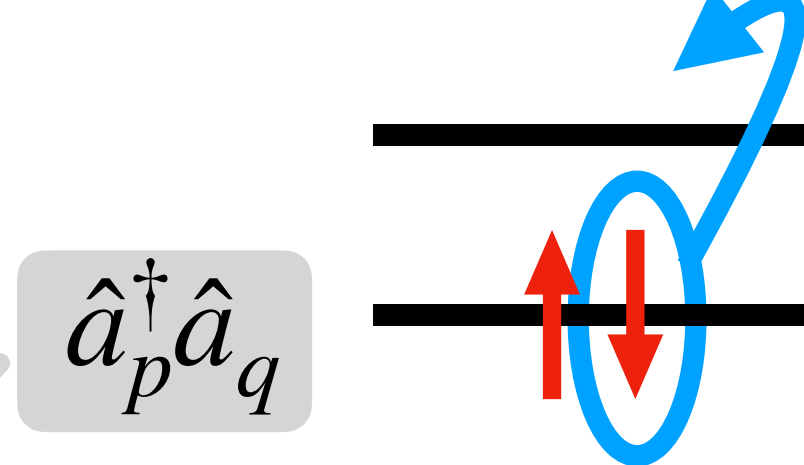
$$\hat{T}(\vec{\theta}) = \sum_l^{\text{exc. op.}} \theta_l \hat{\tau}_l$$

$$\hat{U}(\vec{\theta}) = e^{\hat{T}(\vec{\theta}) - \hat{T}(\vec{\theta})^\dagger}$$

Trotterization

$$\hat{U}(\vec{\theta}) \approx \prod_l e^{\theta_l (\hat{\tau}_l - \hat{\tau}_l^\dagger)}$$

III) Near Term Era: Variational Quantum Eigensolver

Unitary Coupled Cluster ansatz

Romero, Jonathan, et al. "Strategies for quantum computing molecular energies using the unitary coupled cluster ansatz." *Quantum Science and Technology* 4.1 (2018): 014008.

1) Start from an excitation operator

$$\hat{T}(\vec{\theta}) = \sum_l^{\text{exc. op.}} \theta_l \hat{\tau}_l$$

$$\hat{U}(\vec{\theta}) = e^{\hat{T}(\vec{\theta}) - \hat{T}(\vec{\theta})^\dagger}$$

Trotterization

$$\hat{U}(\vec{\theta}) \approx \prod_l e^{\theta_l (\hat{\tau}_l - \hat{\tau}_l^\dagger)}$$

2) Use Jordan-Wigner to translate into qubit algebra

$$\hat{a}_p \xrightarrow{JW} \frac{1}{2} (X_p + iY_p) \bigotimes_{q=0}^{p-1} Z_q$$

$$\hat{a}_p^\dagger \xrightarrow{JW} \frac{1}{2} (X_p - iY_p) \bigotimes_{q=0}^{p-1} Z_q$$

$$\hat{U}(\vec{\theta}) \approx \prod_l^{\text{exc. op.}} \prod_k e^{-i\theta_l \hat{\mathcal{P}}_k^{(l)}}$$

$\hat{\mathcal{P}}_k$ are "Pauli strings"

$$\hat{\mathcal{P}}_k = Z_1 \otimes X_2 \otimes \mathbf{1}_3 \otimes Y_4$$

III) Near Term Era: Variational Quantum Eigensolver

Romero, Jonathan, et al. "Strategies for quantum computing molecular energies using the unitary coupled cluster ansatz." *Quantum Science and Technology* 4.1 (2018): 014008.

Unitary Coupled Cluster ansatz

1) Start from an excitation operator

$$\hat{T}(\vec{\theta}) = \sum_l^{\text{exc. op.}} \theta_l \hat{\tau}_l$$

$$\hat{U}(\vec{\theta}) = e^{\hat{T}(\vec{\theta}) - \hat{T}(\vec{\theta})^\dagger}$$

Trotterization

$$\hat{U}(\vec{\theta}) \approx \prod_l e^{\theta_l (\hat{\tau}_l - \hat{\tau}_l^\dagger)}$$

2) Use Jordan-Wigner to translate into qubit algebra

$$\hat{a}_p \xrightarrow{JW} \frac{1}{2}(X_p + iY_p) \bigotimes_{q=0}^{p-1} Z_q$$

$$\hat{a}_p^\dagger \xrightarrow{JW} \frac{1}{2}(X_p - iY_p) \bigotimes_{q=0}^{p-1} Z_q$$

$$\hat{U}(\vec{\theta}) \approx \prod_l^{\text{exc. op.}} \prod_k e^{-i\theta_l \hat{\mathcal{P}}_k^{(l)}}$$

$\hat{\mathcal{P}}_k$ are "Pauli strings"
 $\hat{\mathcal{P}}_k = Z_1 \otimes X_2 \otimes \mathbf{1}_3 \otimes Y_4$

3) Build the associated circuit

$$\hat{U}(\vec{\theta}) \approx \prod_l^{\text{exc. op.}} \prod_k e^{i\theta_l \hat{\mathcal{P}}_k^{(l)}}$$

III) Near Term Era: Variational Quantum Eigensolver

Romero, Jonathan, et al. "Strategies for quantum computing molecular energies using the unitary coupled cluster ansatz." *Quantum Science and Technology* 4.1 (2018): 014008.

Unitary Coupled Cluster ansatz

1) Start from an excitation operator

$$\hat{T}(\vec{\theta}) = \sum_l^{\text{exc. op.}} \theta_l \hat{\tau}_l$$

$$\hat{U}(\vec{\theta}) = e^{\hat{T}(\vec{\theta}) - \hat{T}(\vec{\theta})^\dagger}$$

Trotterization

$$\hat{U}(\vec{\theta}) \approx \prod_l e^{\theta_l (\hat{\tau}_l - \hat{\tau}_l^\dagger)}$$

2) Use Jordan-Wigner to translate into qubit algebra

$$\hat{a}_p \xrightarrow{JW} \frac{1}{2}(X_p + iY_p) \bigotimes_{q=0}^{p-1} Z_q$$

$$\hat{a}_p^\dagger \xrightarrow{JW} \frac{1}{2}(X_p - iY_p) \bigotimes_{q=0}^{p-1} Z_q$$

$$\hat{U}(\vec{\theta}) \approx \prod_l^{\text{exc. op.}} \prod_k e^{-i\theta_l \hat{\mathcal{P}}_k^{(l)}}$$

$\hat{\mathcal{P}}_k$ are "Pauli strings"
 $\hat{\mathcal{P}}_k = Z_1 \otimes X_2 \otimes \mathbf{1}_3 \otimes Y_4$

3) Build the associated circuit

$$\hat{U}(\vec{\theta}) \approx \prod_l^{\text{exc. op.}} \prod_k e^{i\theta_l \hat{\mathcal{P}}_k^{(l)}}$$

✓ ✗ Polynomial cost

✓ Conserved number of particle

✓ Simpler to optimize

III) Near Term Era: Variational Quantum Eigensolver

The diagram illustrates the decomposition of a unitary operator $\hat{U}(\vec{\theta})$ into a sequence of excitation operators. On the left, a gray box labeled $\hat{U}(\vec{\theta})$ has four input and four output lines. This is followed by an approximation symbol \approx . Above the approximation is the text *exc. op.*. Below the approximation are two nested product symbols $\prod_l \prod_k$. To the right of the products is another gray box labeled $e^{i\theta_l \hat{\mathcal{P}}_k^{(l)}}$, which also has four input and four output lines.

$$\hat{U}(\vec{\theta}) \approx \prod_l \prod_k e^{i\theta_l \hat{\mathcal{P}}_k^{(l)}}$$

III) Near Term Era: Variational Quantum Eigensolver

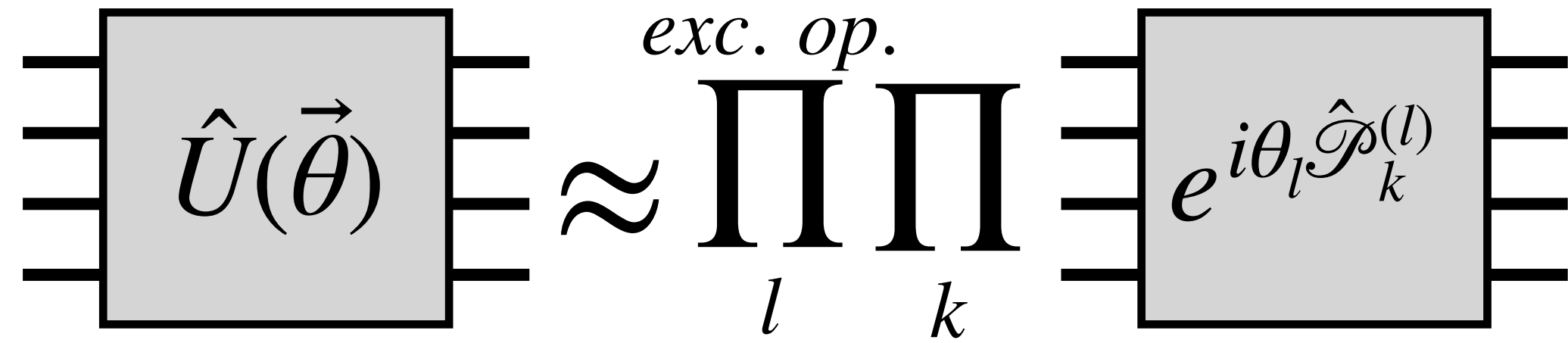

QUESTION Which *circuit* could encode this exponential of Pauli String ?

$$e^{-i\theta Z_A X_B} = \cos(\theta)\mathbf{1} - i \sin(\theta)Z_A X_B$$

III) Near Term Era: Variational Quantum Eigensolver

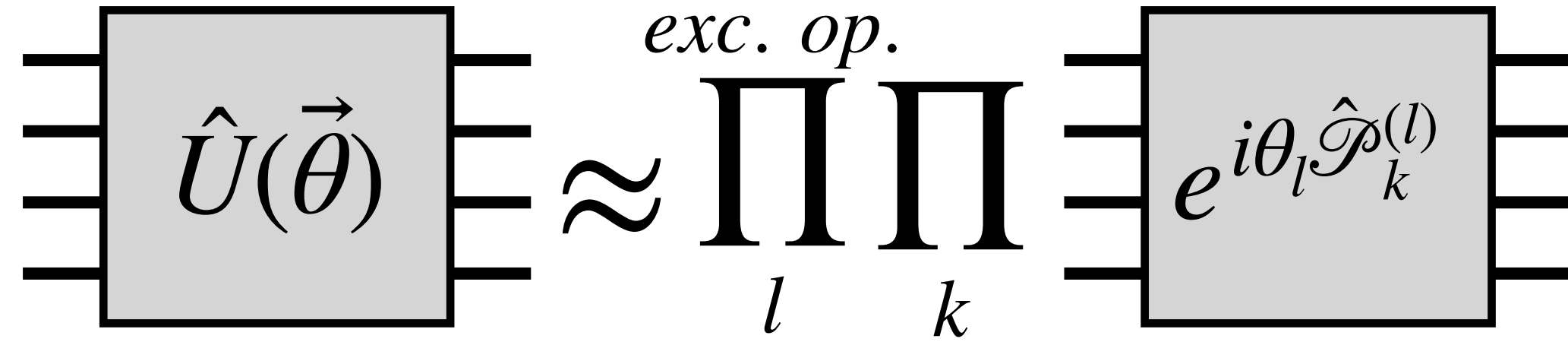

QUESTION Which *circuit* could encode this exponential of Pauli String ?

$$e^{-i\theta Z_A X_B} = \cos(\theta)\mathbf{1} - i \sin(\theta)Z_A X_B$$

$$e^{-i\theta Z_q} = R_{Z_q}(2\theta) = \cos(\theta)\mathbf{1}_q - i \sin(\theta)Z_q$$

$$C_{qq'}^X Z_{q'} C_{qq'}^X = Z_q Z_{q'}$$

$$R_{Y_q}(\pi/2) Z_q R_{Y_q}(-\pi/2) = X_q$$

III) Near Term Era: Variational Quantum Eigensolver

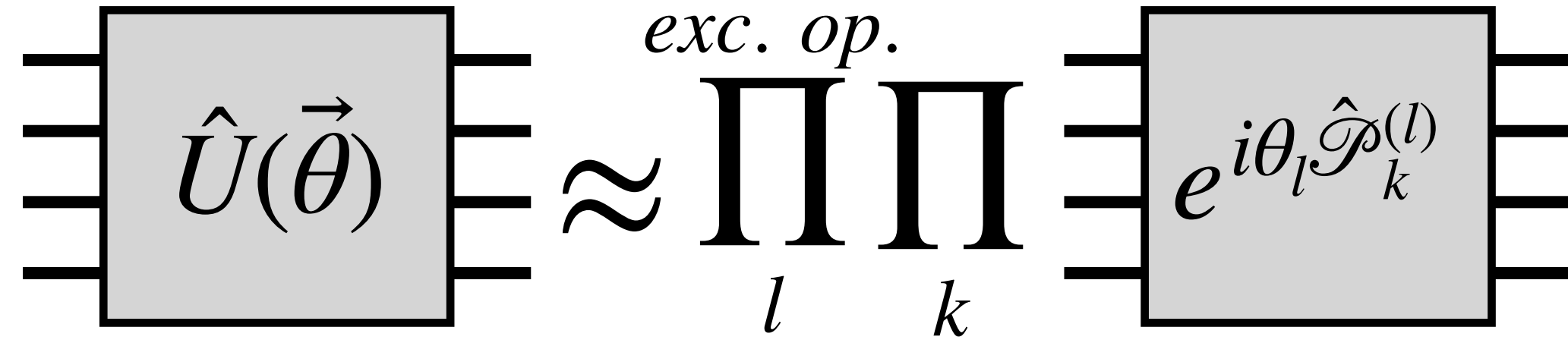

QUESTION Which *circuit* could encode this exponential of Pauli String ?

$$e^{-i\theta Z_A X_B} = \cos(\theta)\mathbf{1} - i \sin(\theta)Z_A X_B$$

$$e^{-i\theta Z_q} = R_{Z_q}(2\theta) = \cos(\theta)\mathbf{1}_q - i \sin(\theta)Z_q$$

$$C_{qq'}^X Z_{q'} C_{qq'}^X = Z_q Z_{q'}$$

$$R_{Y_q}(\pi/2) Z_q R_{Y_q}(-\pi/2) = X_q$$

Shape of the circuit

III) Near Term Era: Variational Quantum Eigensolver

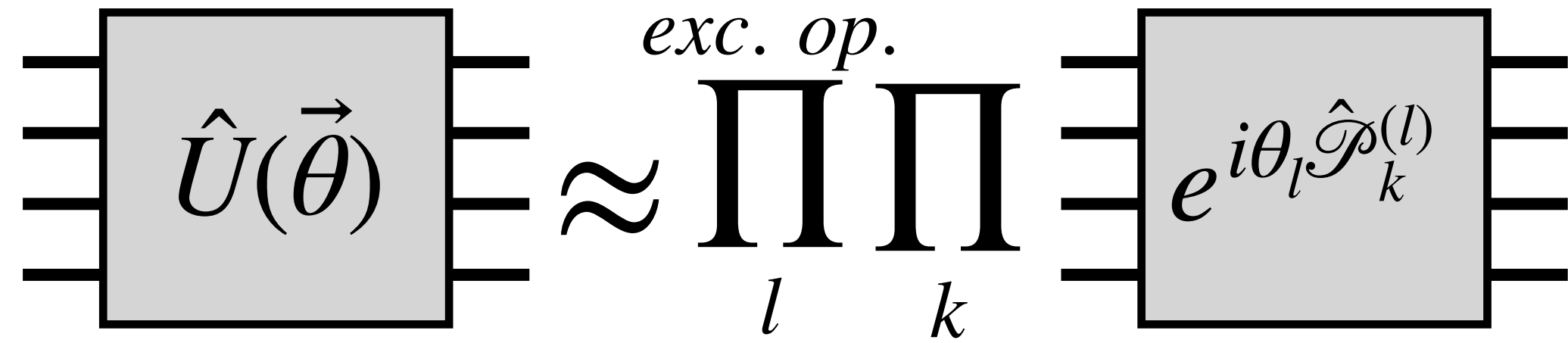

QUESTION Which *circuit* could encode this exponential of Pauli String ?

$$e^{-i\theta Z_A X_B} = \cos(\theta)1 - i \sin(\theta) Z_A X_B$$

$$e^{-i\theta Z_q} = R_{Z_q}(2\theta) = \cos(\theta)1_q - i \sin(\theta)Z_q$$

$$C_{qq'}^X Z_{q'} C_{qq'}^X = Z_q Z_{q'}$$

$$R_{Y_q}(\pi/2) Z_q R_{Y_q}(-\pi/2) = X_q$$

Shape of the circuit

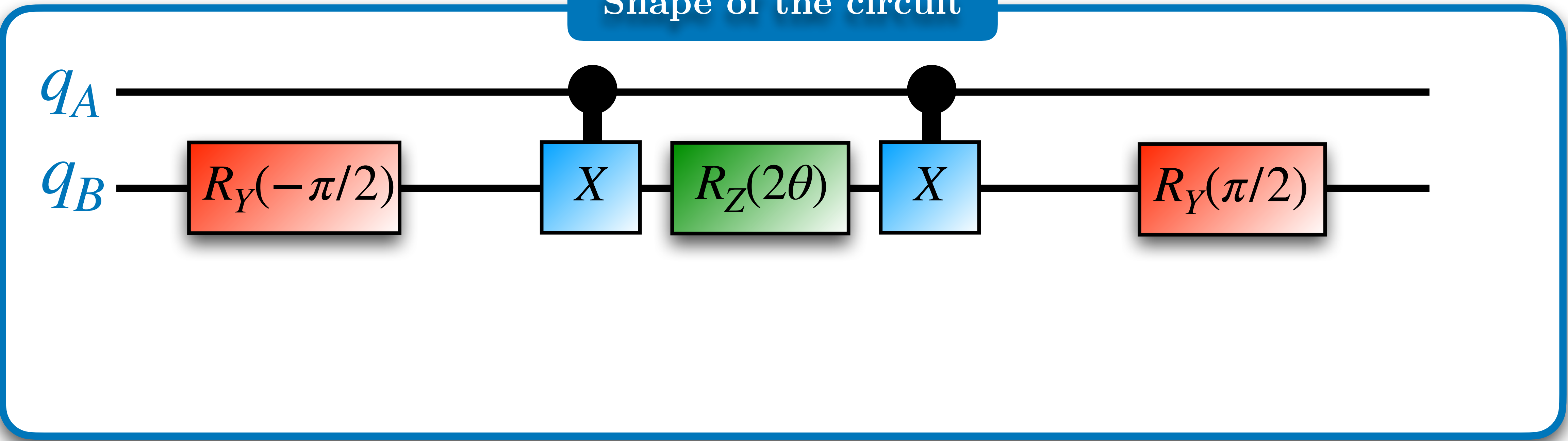

III) Near Term Era: Variational Quantum Eigensolver

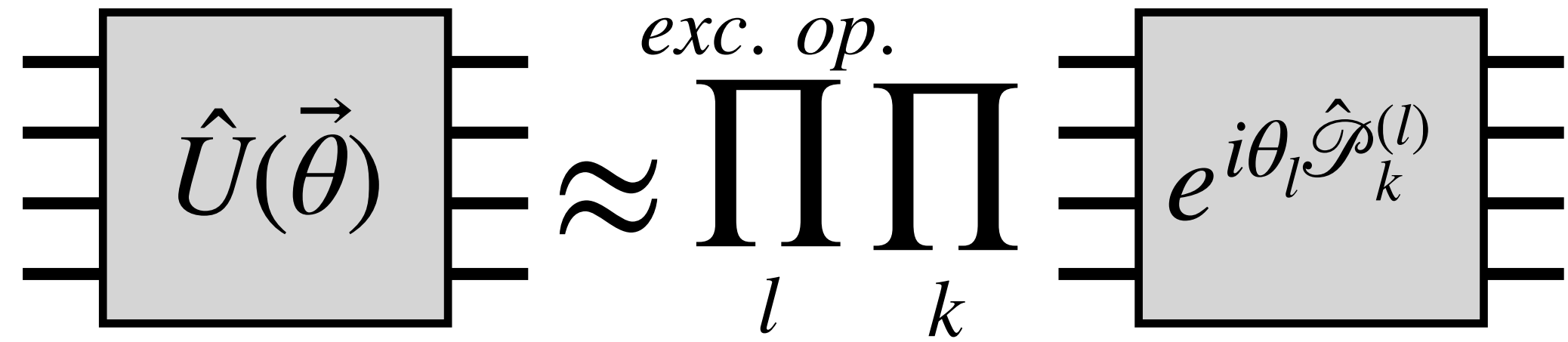

QUESTION Which *circuit* could encode this exponential of Pauli String ?

$$e^{-i\theta Z_A X_B} = \cos(\theta) \mathbf{1} - i \sin(\theta) Z_A X_B$$

$$e^{-i\theta Z_q} = R_{Z_q}(2\theta) = \cos(\theta) \mathbf{1}_q - i \sin(\theta) Z_q$$

$$C_{qq'}^X Z_{q'} C_{qq'}^X = Z_q Z_{q'}$$

$$R_{Y_q}(\pi/2) Z_q R_{Y_q}(-\pi/2) = X_q$$

Shape of the circuit

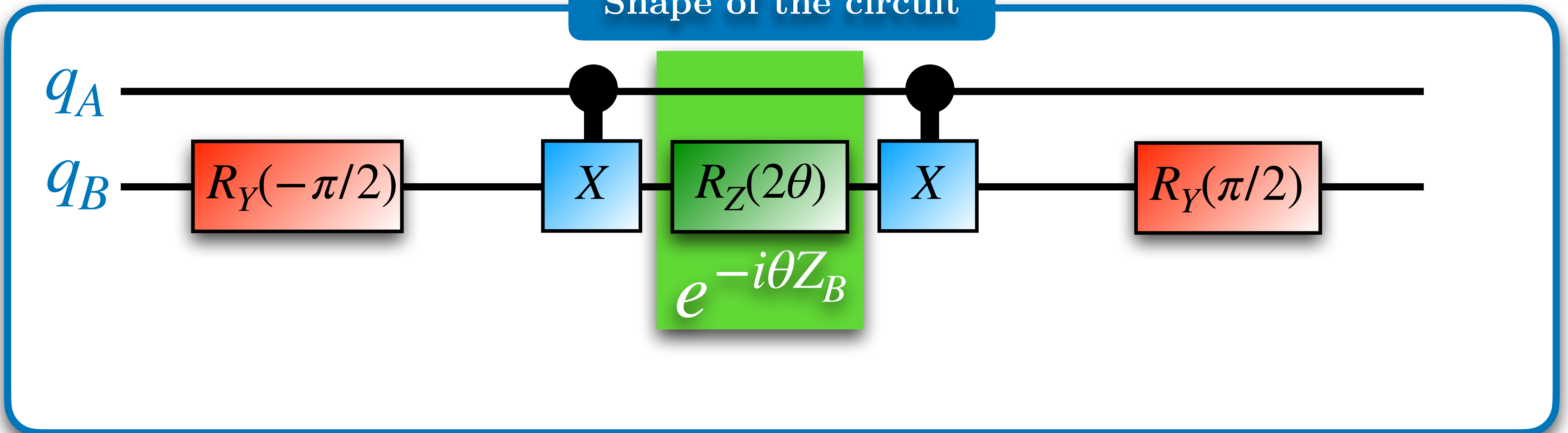

III) Near Term Era: Variational Quantum Eigensolver

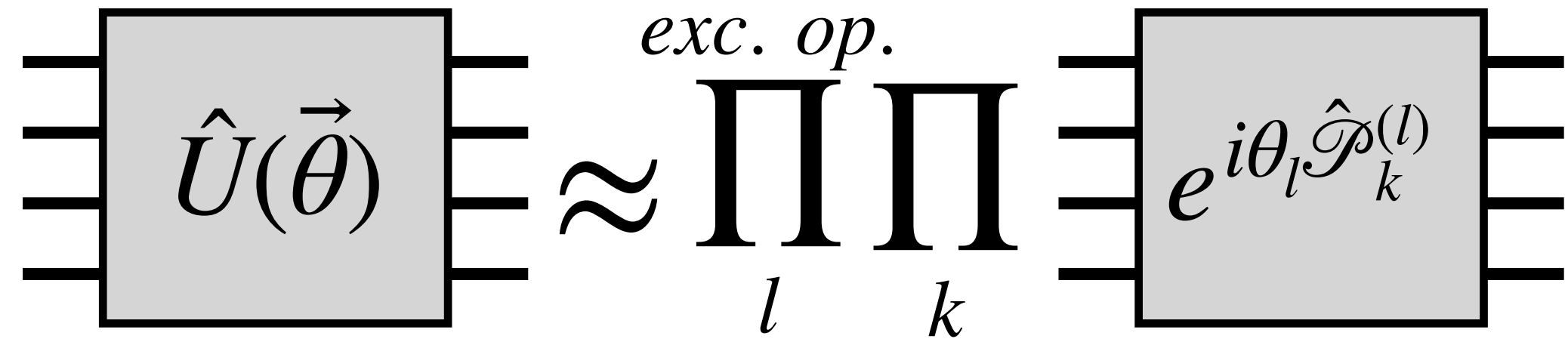

QUESTION Which *circuit* could encode this exponential of Pauli String ?

$$e^{-i\theta Z_A X_B} = \cos(\theta) \mathbf{1} - i \sin(\theta) Z_A X_B$$

$$e^{-i\theta Z_q} = R_{Z_q}(2\theta) = \cos(\theta) \mathbf{1}_q - i \sin(\theta) Z_q$$

$$C_{qq'}^X Z_{q'} C_{qq'}^X = Z_q Z_{q'}$$

$$R_{Y_q}(\pi/2) Z_q R_{Y_q}(-\pi/2) = X_q$$

Shape of the circuit

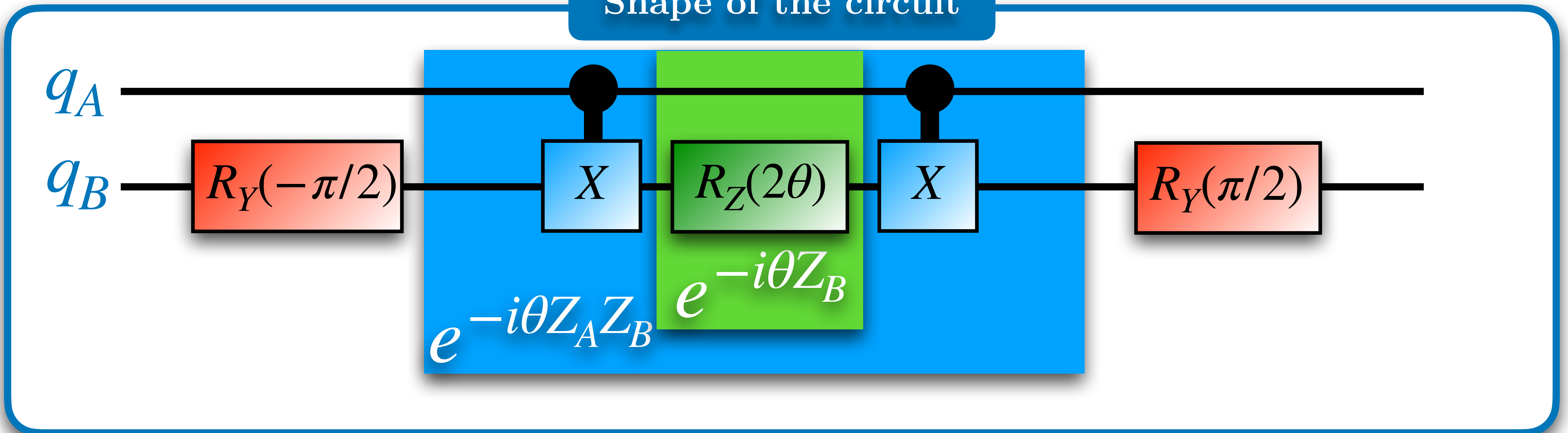

III) Near Term Era: Variational Quantum Eigensolver

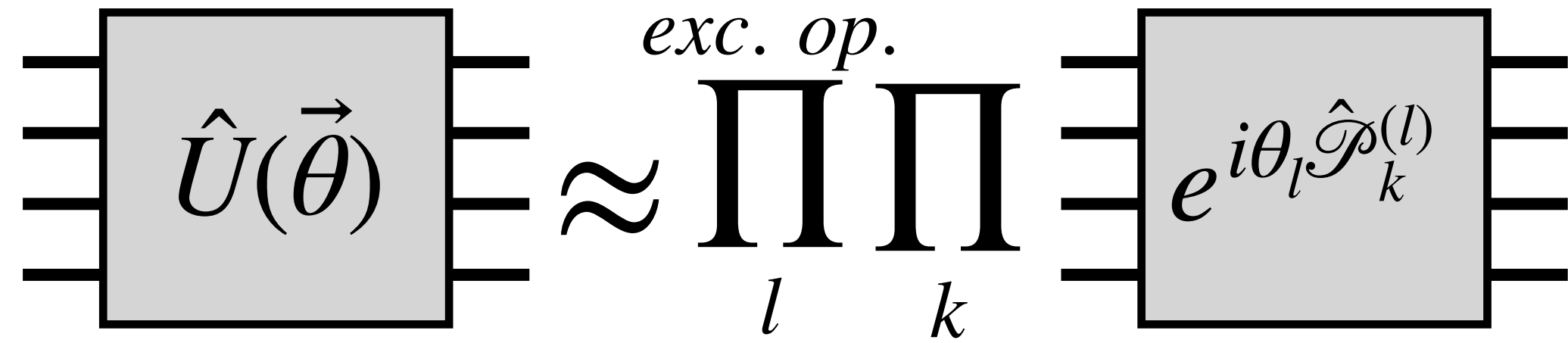

QUESTION Which *circuit* could encode this exponential of Pauli String ?

$$e^{-i\theta Z_A X_B} = \cos(\theta)\mathbf{1} - i \sin(\theta)Z_A X_B$$

$$e^{-i\theta Z_q} = R_{Z_q}(2\theta) = \cos(\theta)\mathbf{1}_q - i \sin(\theta)Z_q$$

$$C_{qq'}^X Z_{q'} C_{qq'}^X = Z_q Z_{q'}$$

$$R_{Y_q}(\pi/2) Z_q R_{Y_q}(-\pi/2) = X_q$$

Shape of the circuit

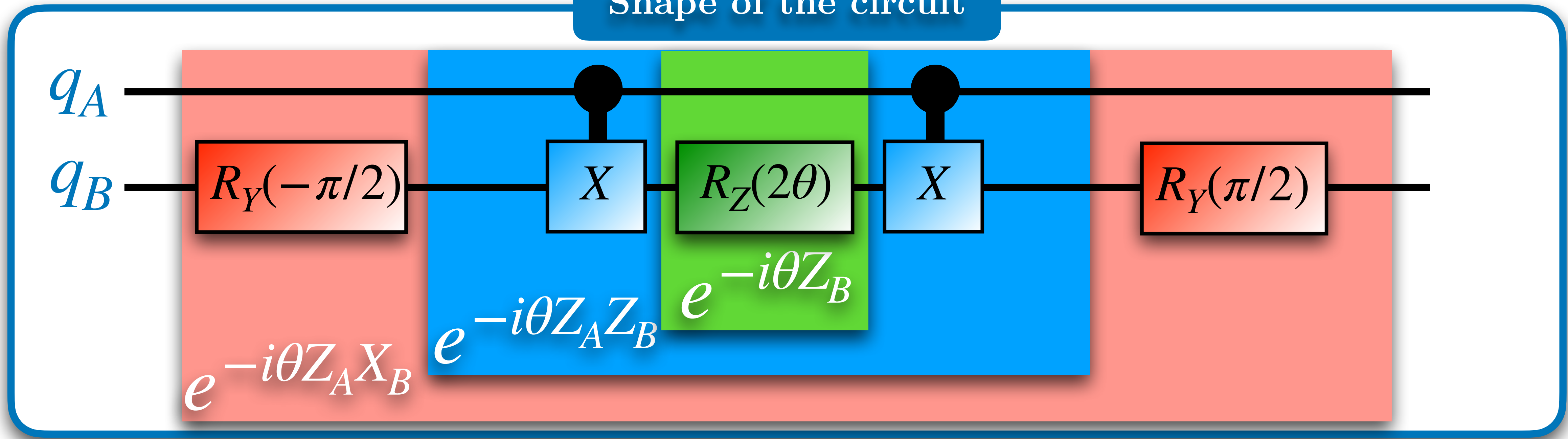

$$e^{-i\theta Y_0 Y_1 Y_2}$$

III) Near Term Era: Variational Quantum Eigensolver

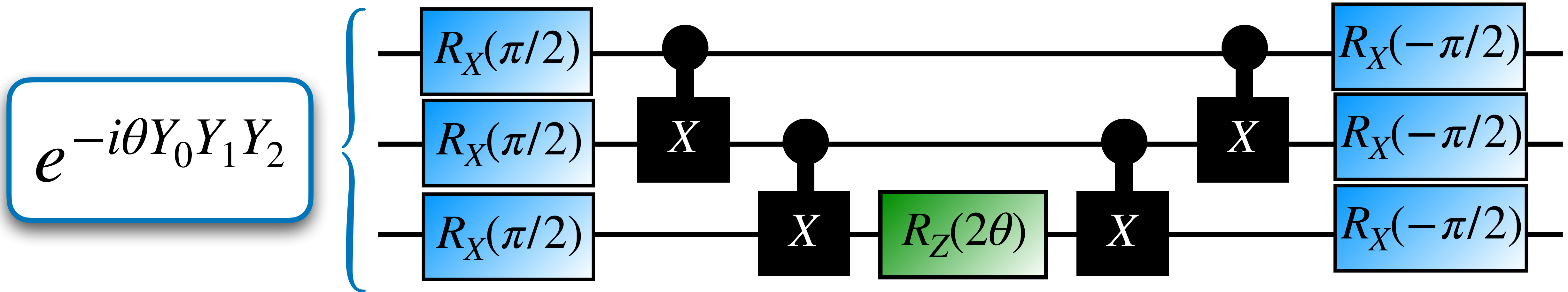

III) Near Term Era: Variational Quantum Eigensolver

$$e^{-i\theta Y_0 Y_1 Y_2}$$

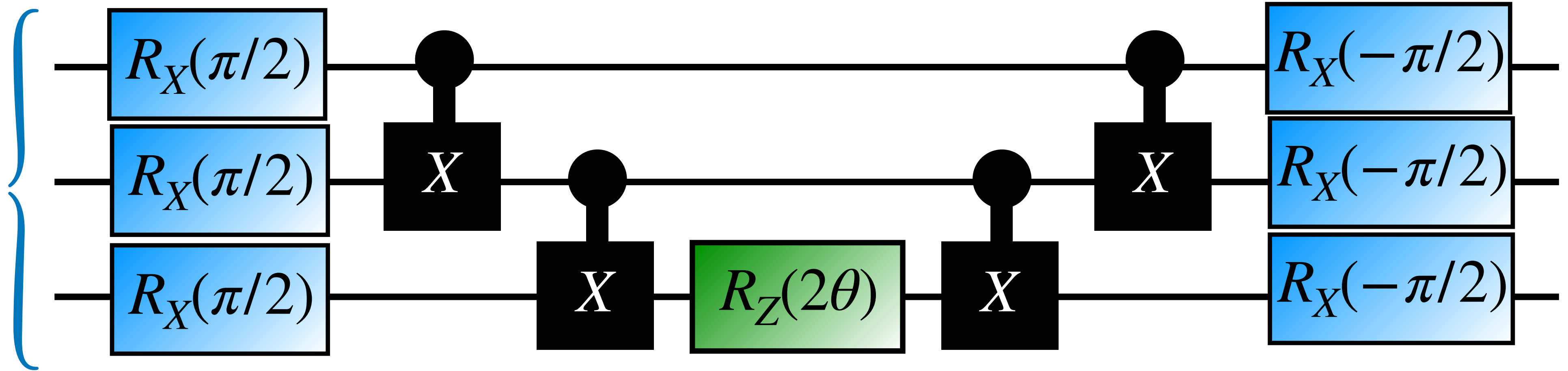

$$e^{-i\theta Y_0 Z_1 X_2}$$

III) Near Term Era: Variational Quantum Eigensolver

$$e^{-i\theta Y_0 Y_1 Y_2}$$

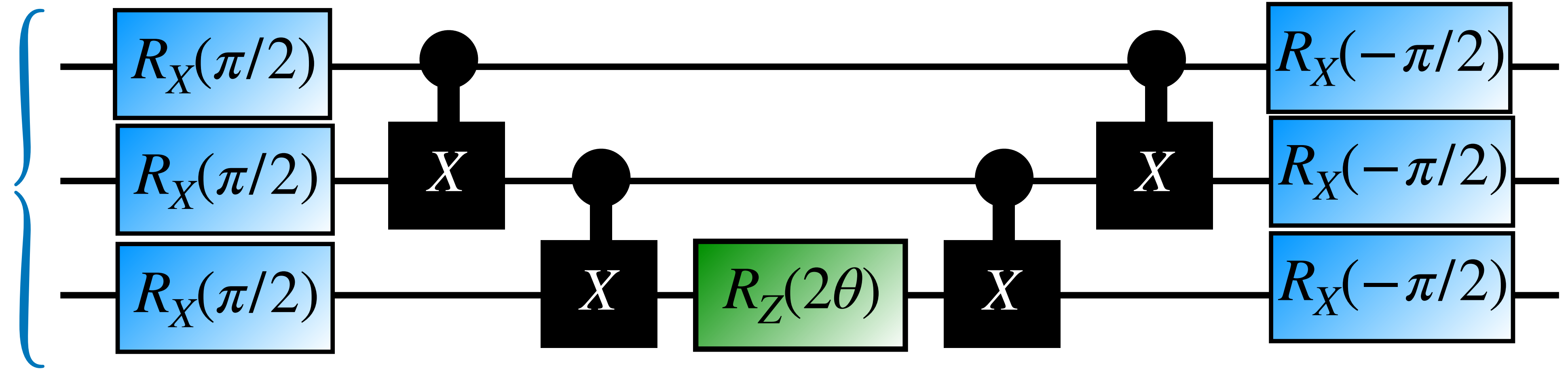

$$e^{-i\theta Y_0 Z_1 X_2}$$

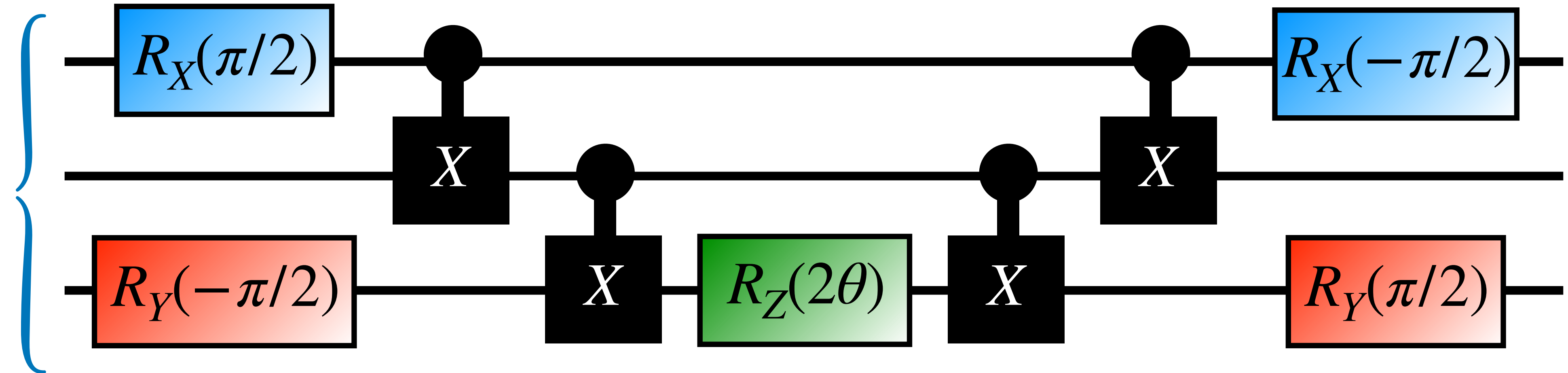

IV) Fault Tolerant Era: Quantum Phase Estimation

GOAL: we want to know ω

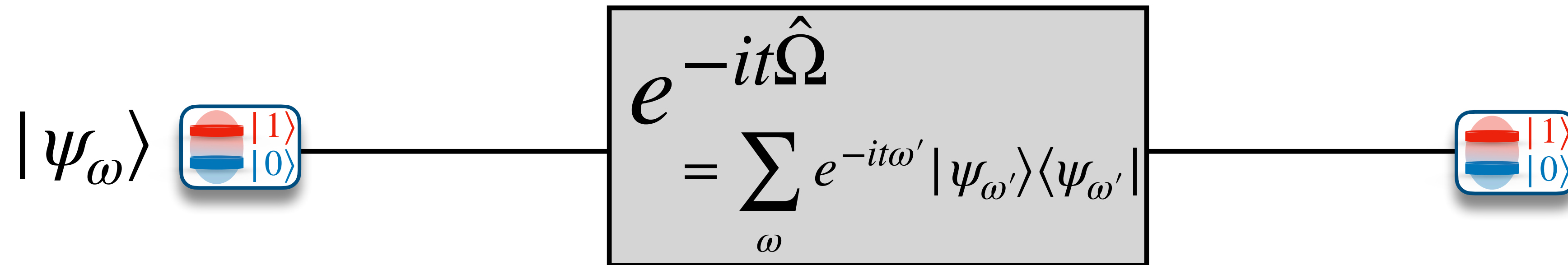

IV) Fault Tolerant Era: Quantum Phase Estimation

GOAL: we want to know ω

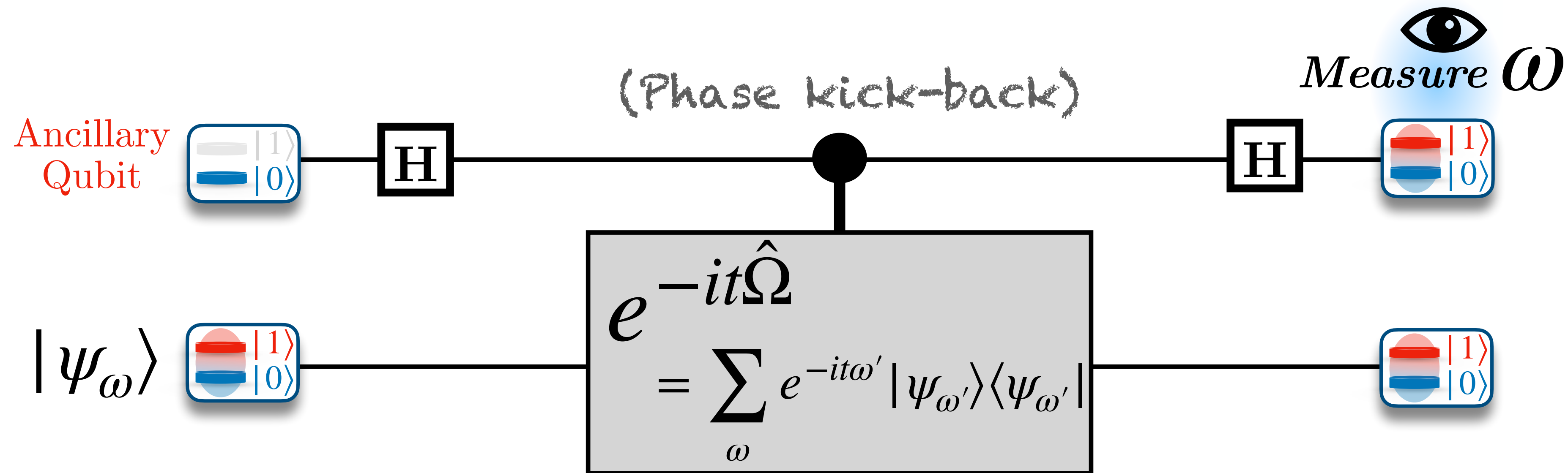

IV) Fault Tolerant Era: Quantum Phase Estimation

GOAL: we want to know ω

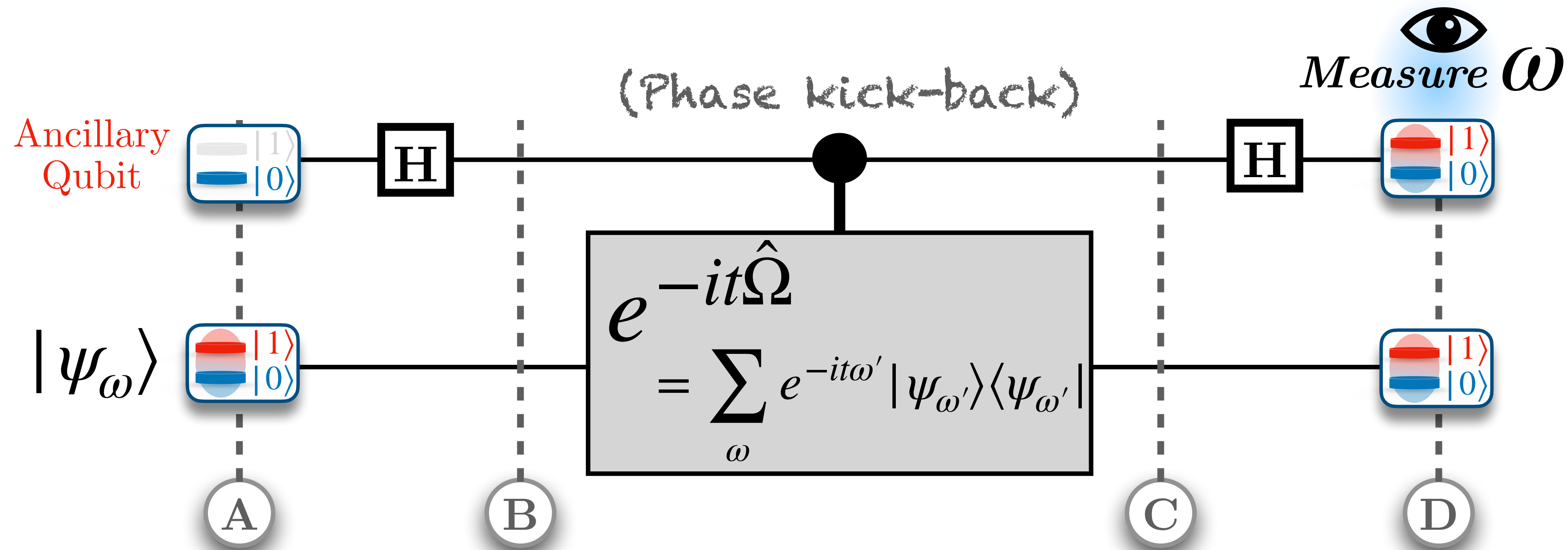

IV) Fault Tolerant Era: Quantum Phase Estimation

GOAL: we want to know ω

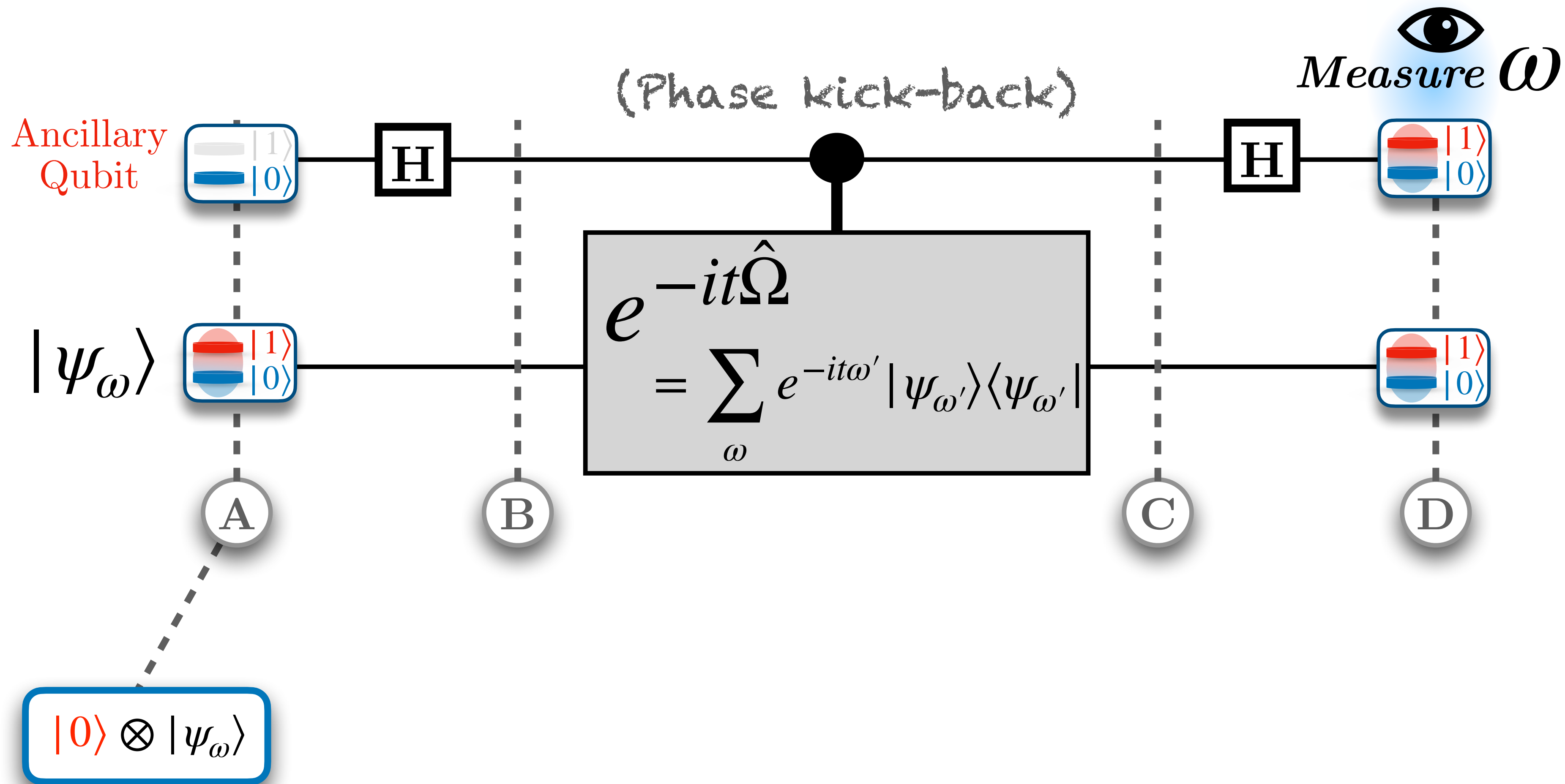

IV) Fault Tolerant Era: Quantum Phase Estimation

GOAL: we want to know ω

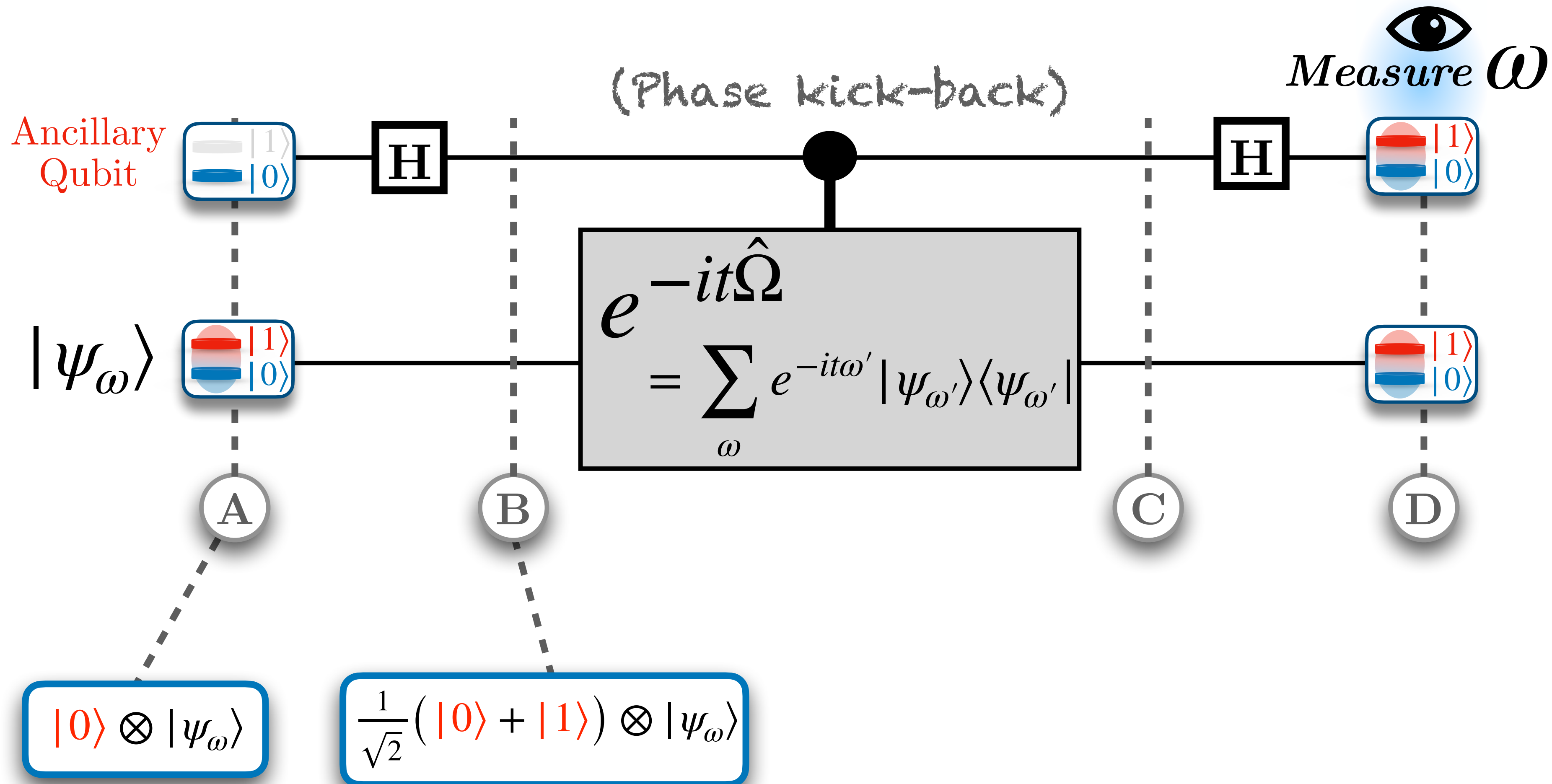

IV) Fault Tolerant Era: Quantum Phase Estimation

GOAL: we want to know ω

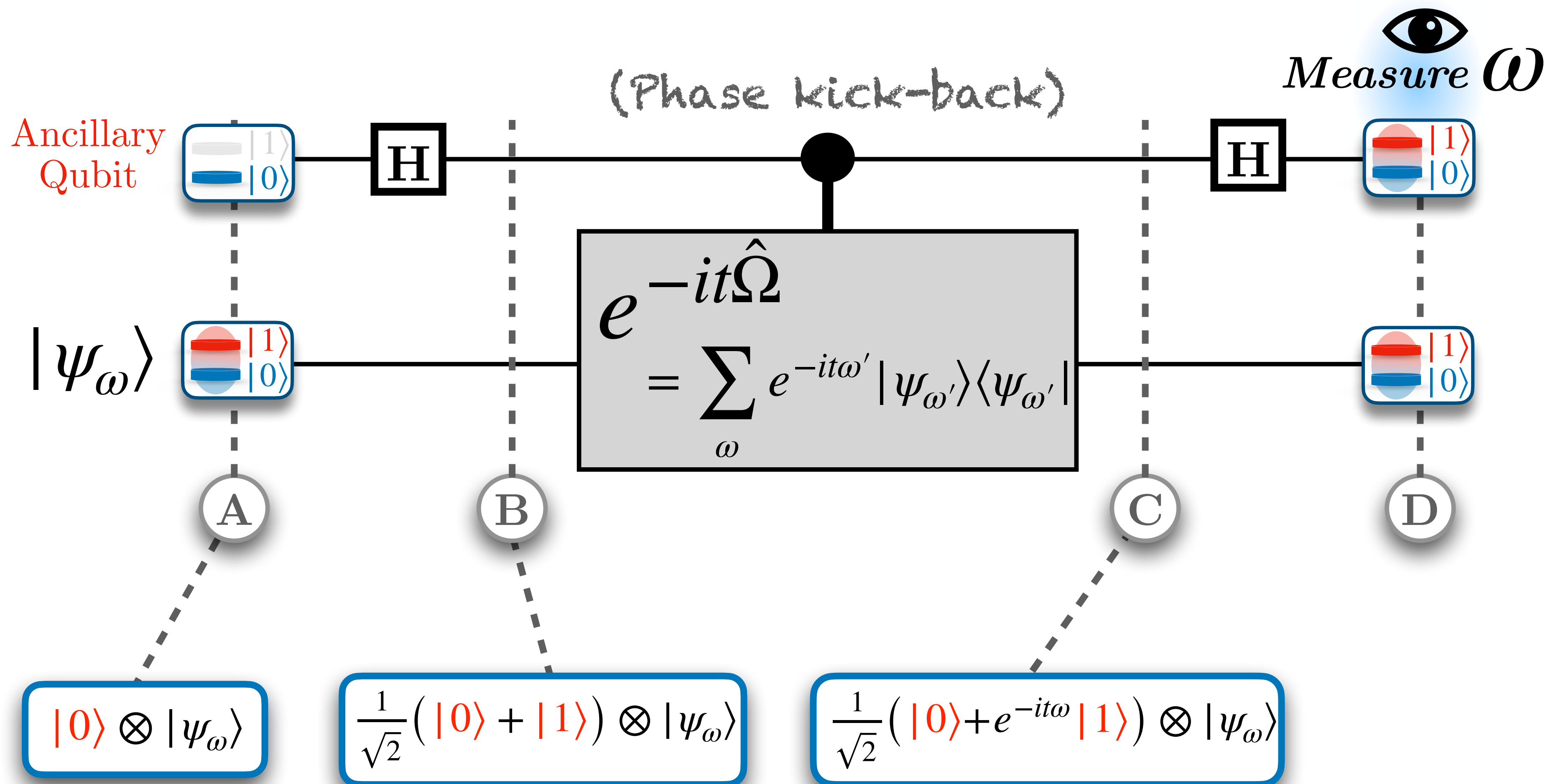

IV) Fault Tolerant Era: Quantum Phase Estimation

GOAL: we want to know ω

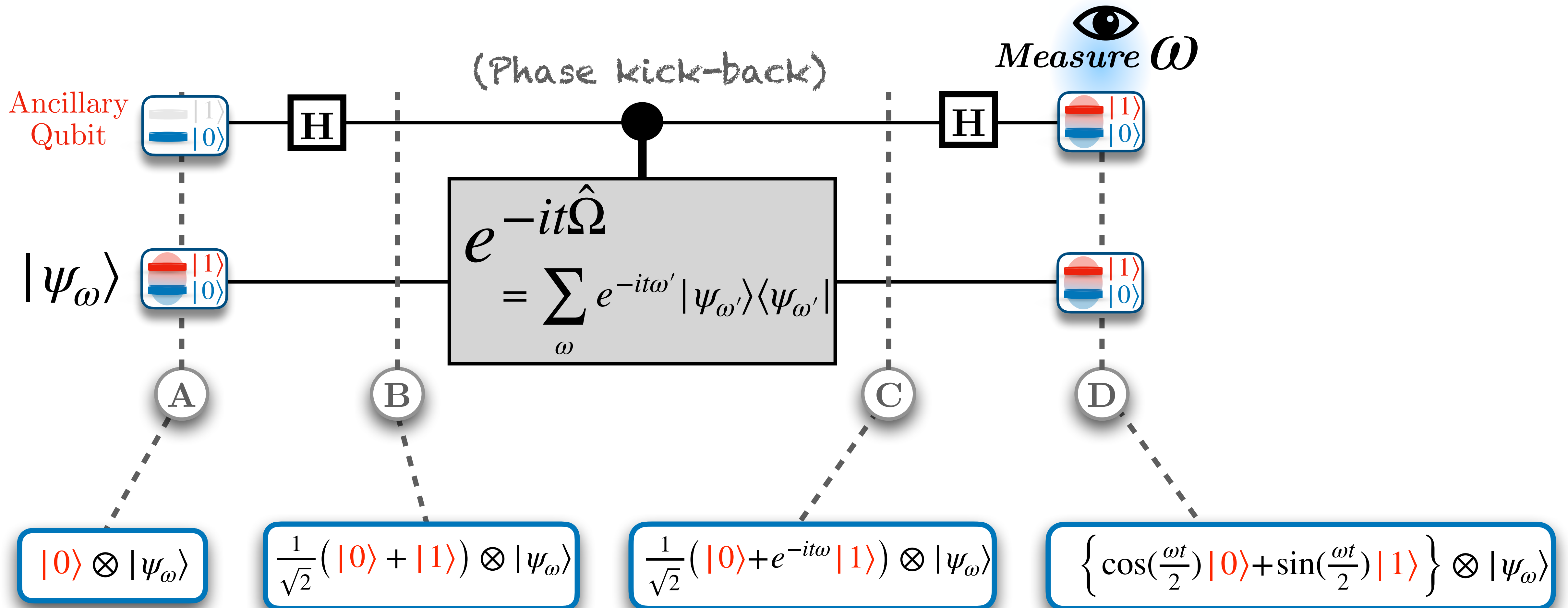

IV) Fault Tolerant Era: Quantum Phase Estimation

GOAL: we want to know ω

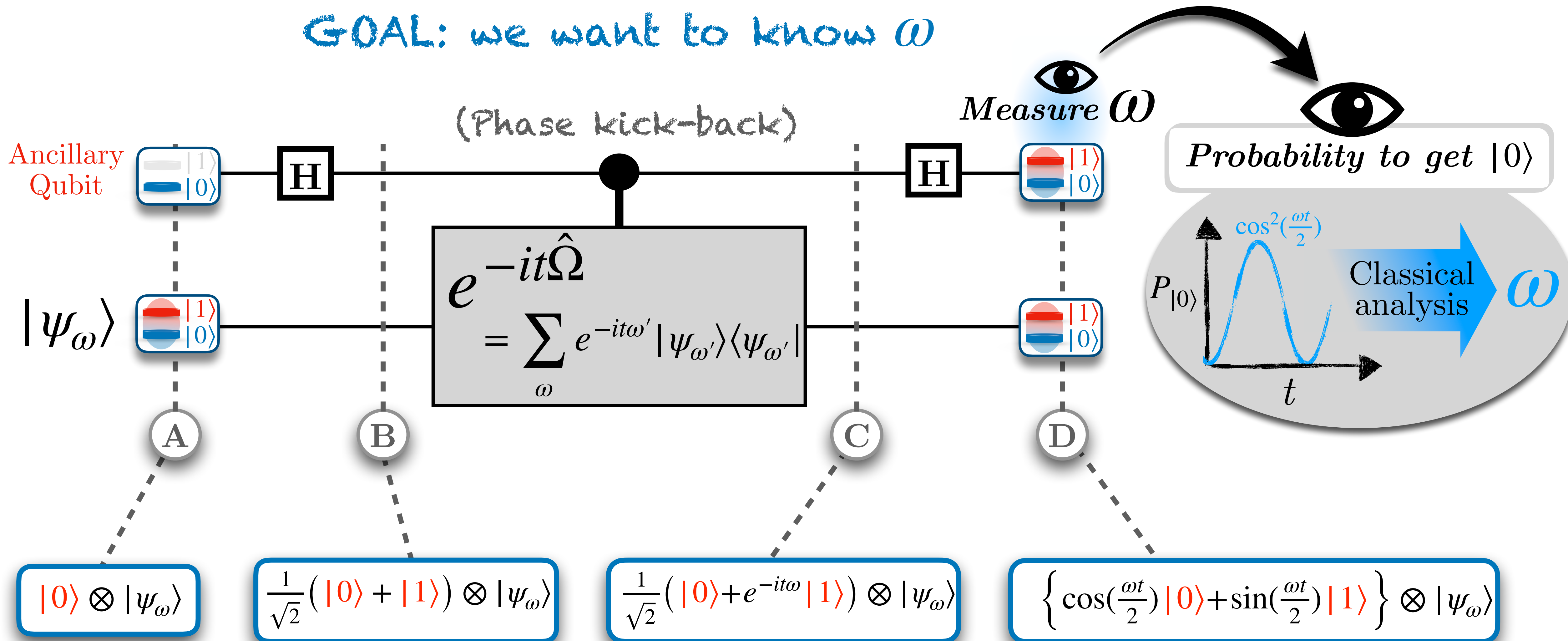

IV) Fault Tolerant Era: Quantum Phase Estimation

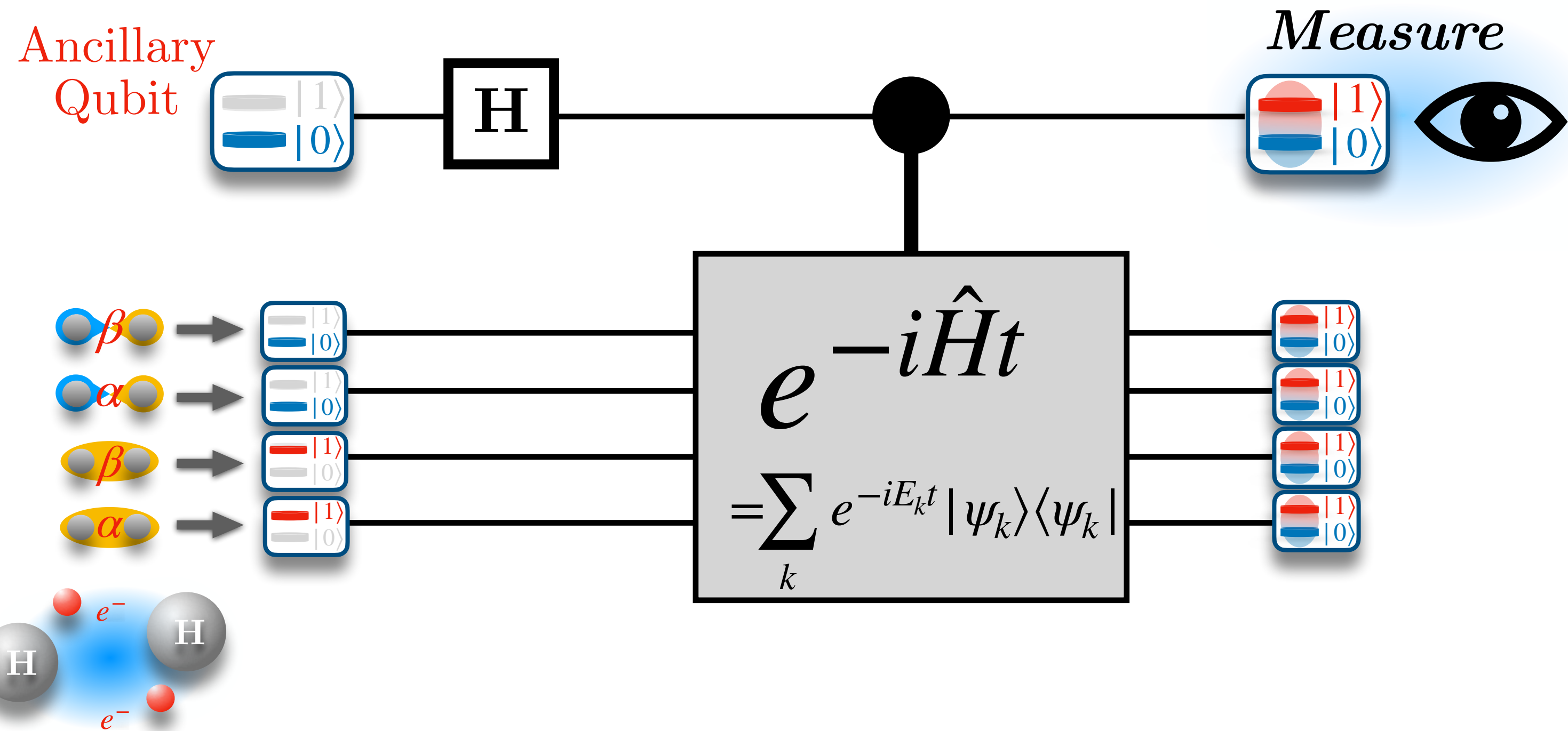

IV) Fault Tolerant Era: Quantum Phase Estimation

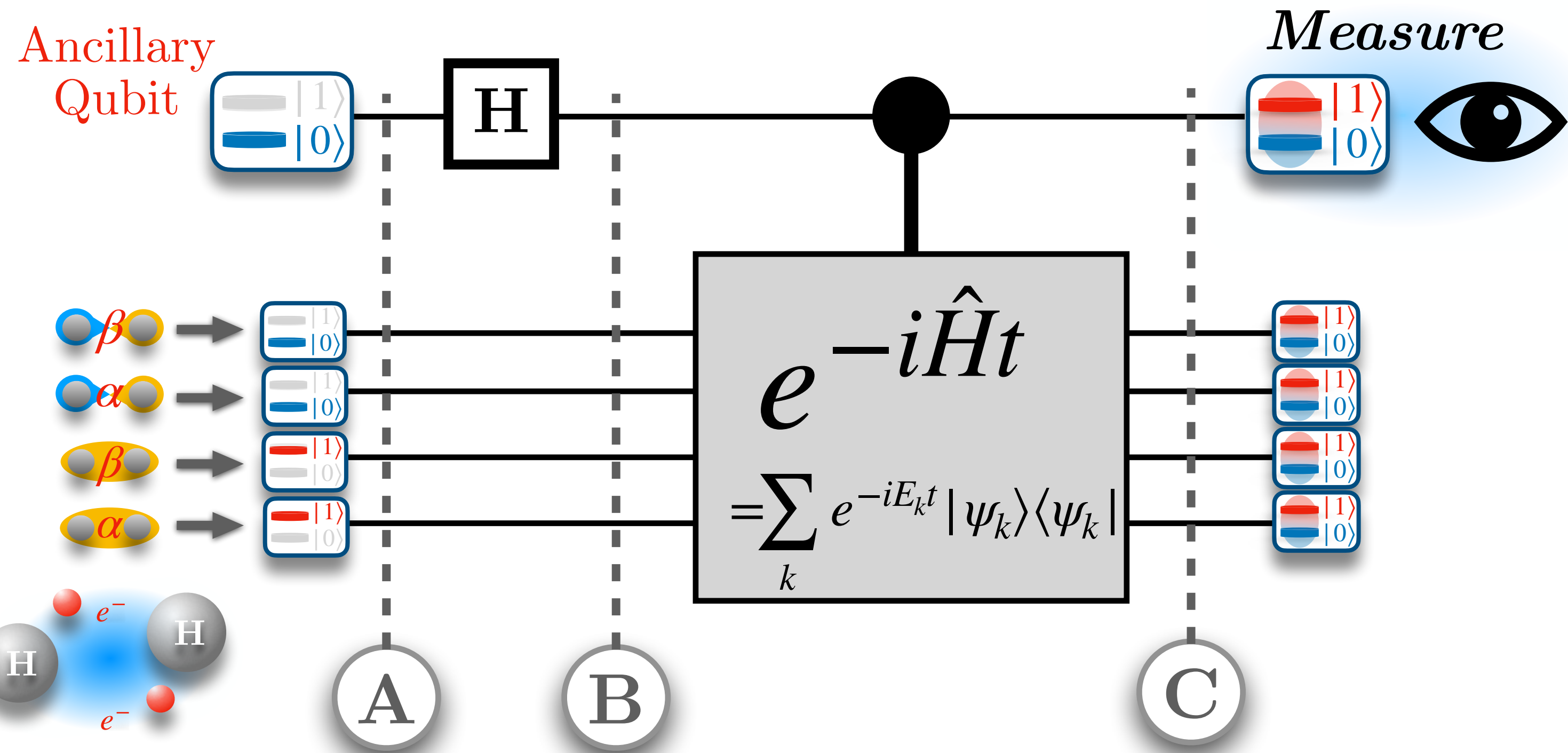

IV) Fault Tolerant Era: Quantum Phase Estimation

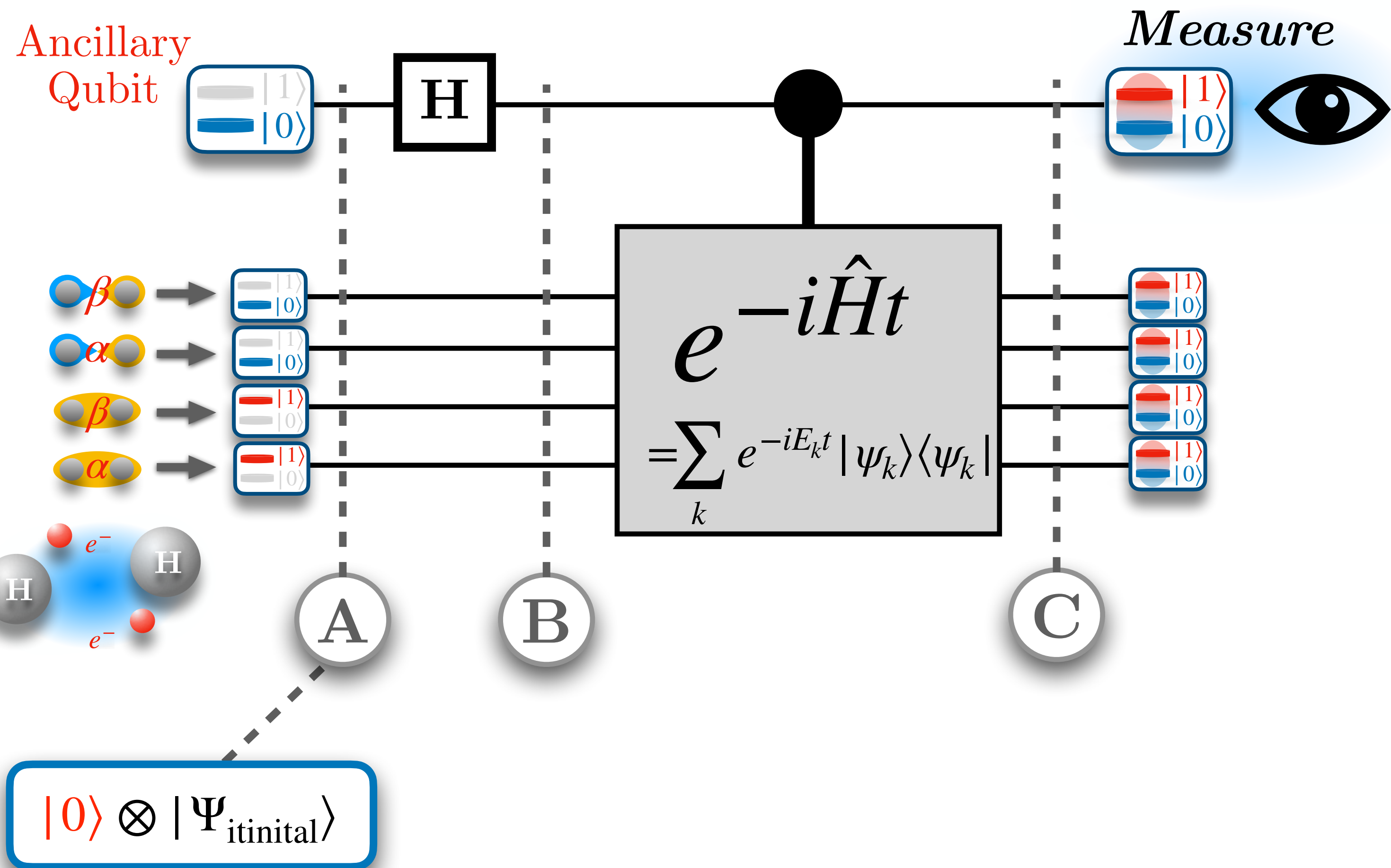

IV) Fault Tolerant Era: Quantum Phase Estimation

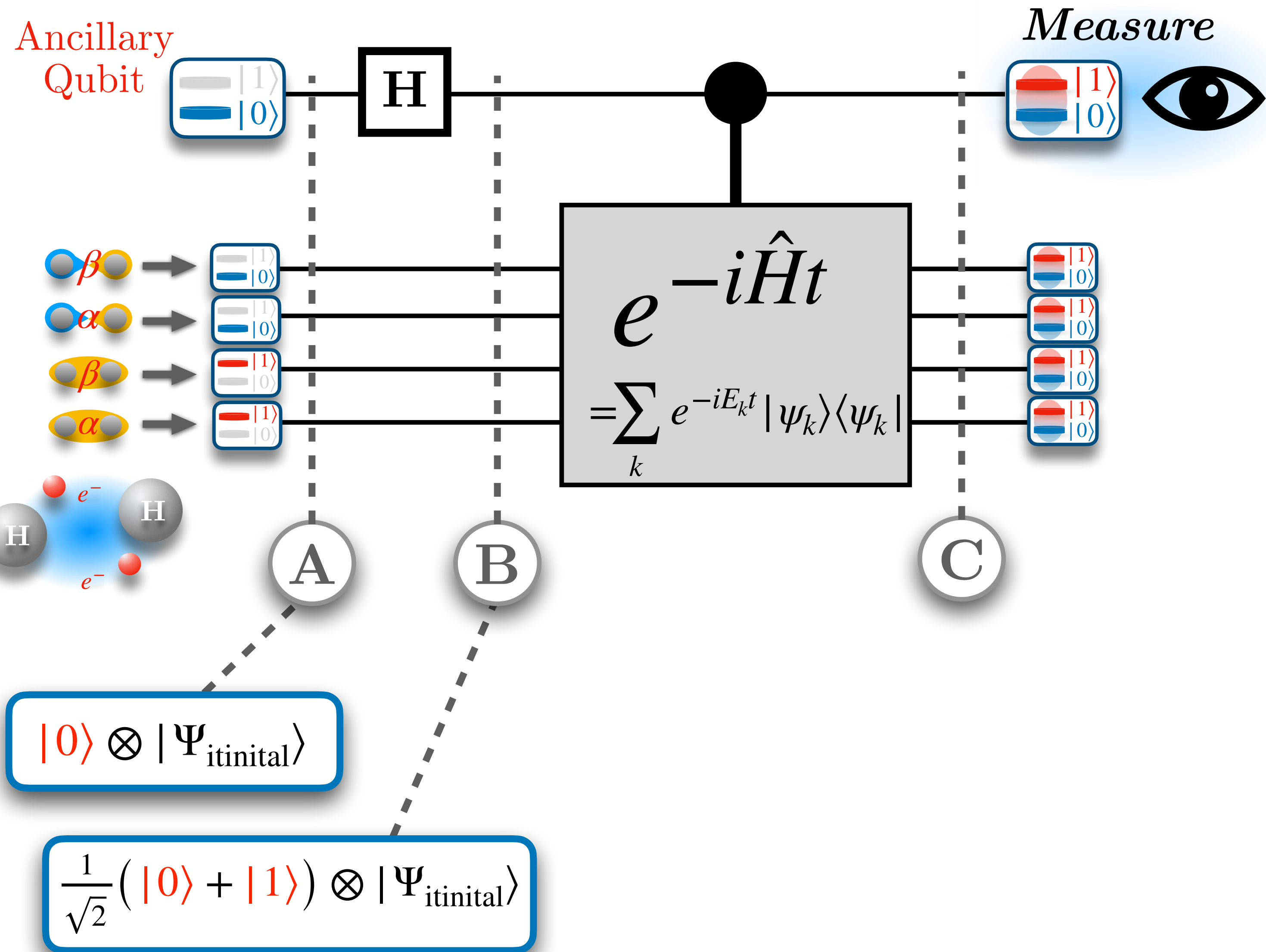

IV) Fault Tolerant Era: Quantum Phase Estimation



$$e^{-i\hat{H}t}$$

$$= \sum_k e^{-iE_k t} |\psi_k\rangle\langle\psi_k|$$

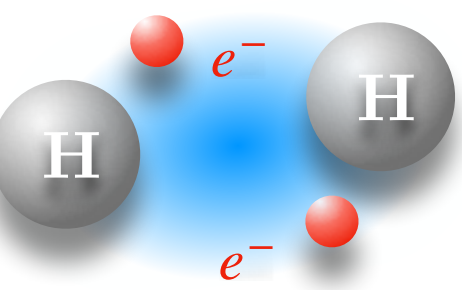

A

B

C

$$|0\rangle \otimes |\Psi_{\text{initial}}\rangle$$

$$\frac{1}{\sqrt{2}} (|0\rangle + |1\rangle) \otimes |\Psi_{\text{initial}}\rangle$$

$$\frac{1}{\sqrt{2}} \sum_k (|0\rangle + |1\rangle e^{-iE_k t}) \otimes C_k |\psi_k\rangle$$

$$C_k = \langle\psi_k | \Psi_{\text{initial}}\rangle$$

IV) Fault Tolerant Era: Quantum Phase Estimation

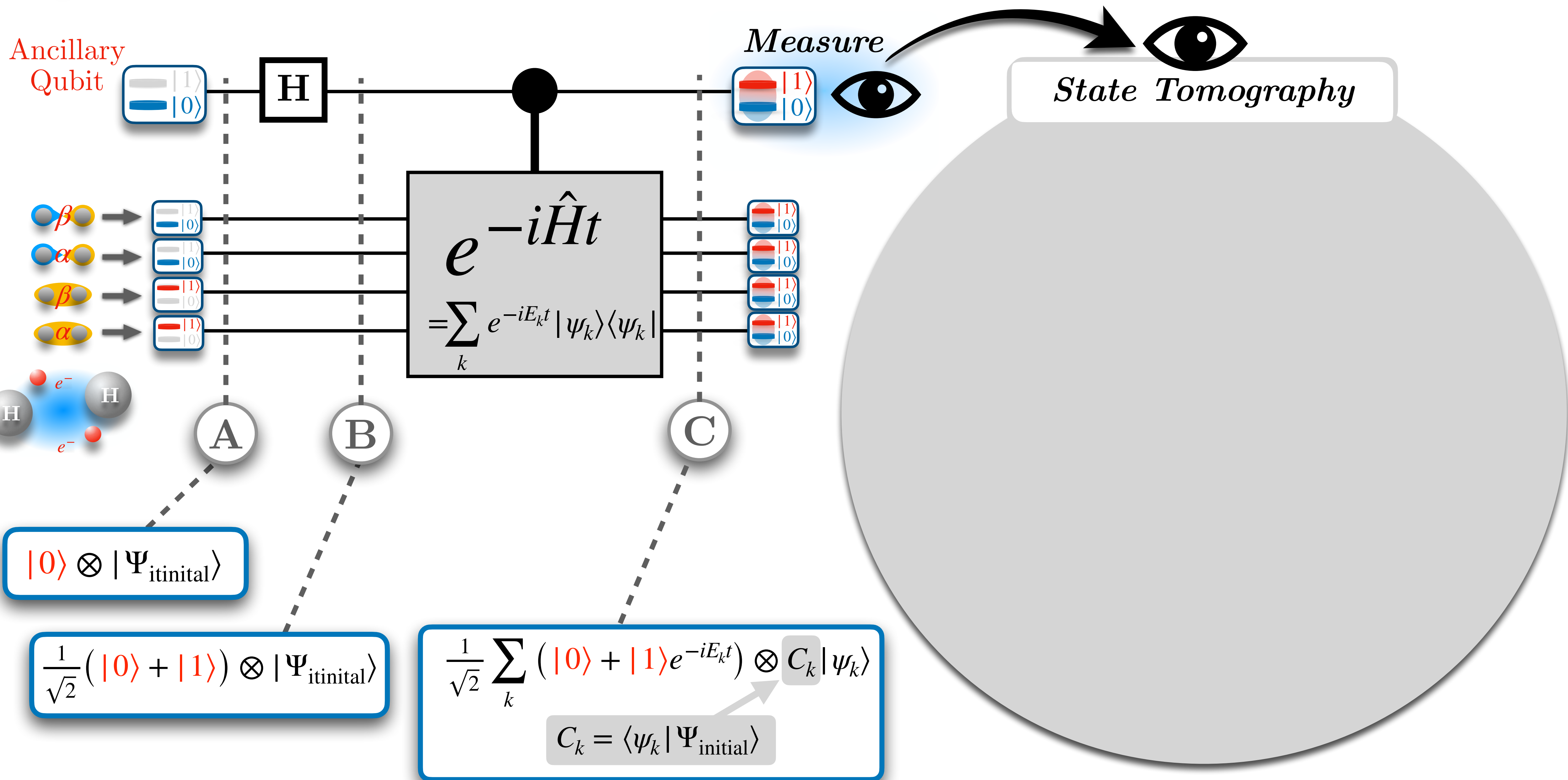

IV) Fault Tolerant Era: Quantum Phase Estimation

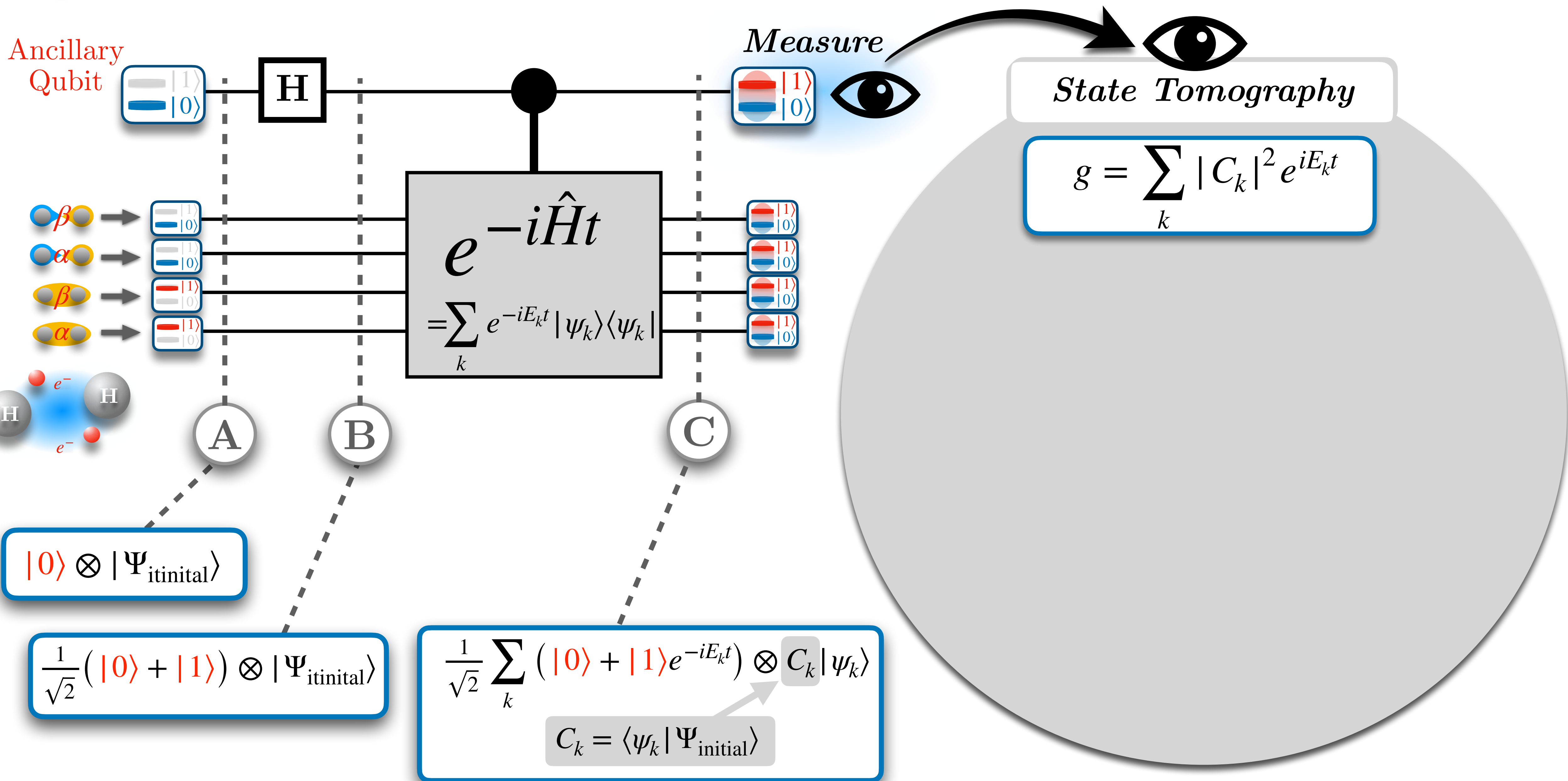

IV) Fault Tolerant Era: Quantum Phase Estimation

Ancillary Qubit

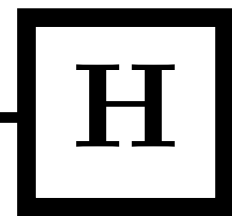

Measure

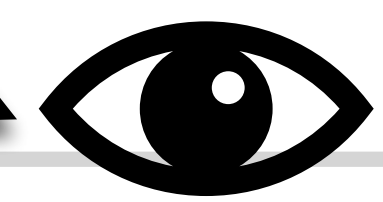
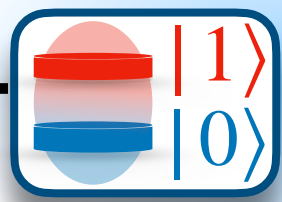

State Tomography

$$g = \sum_k |C_k|^2 e^{iE_k t}$$

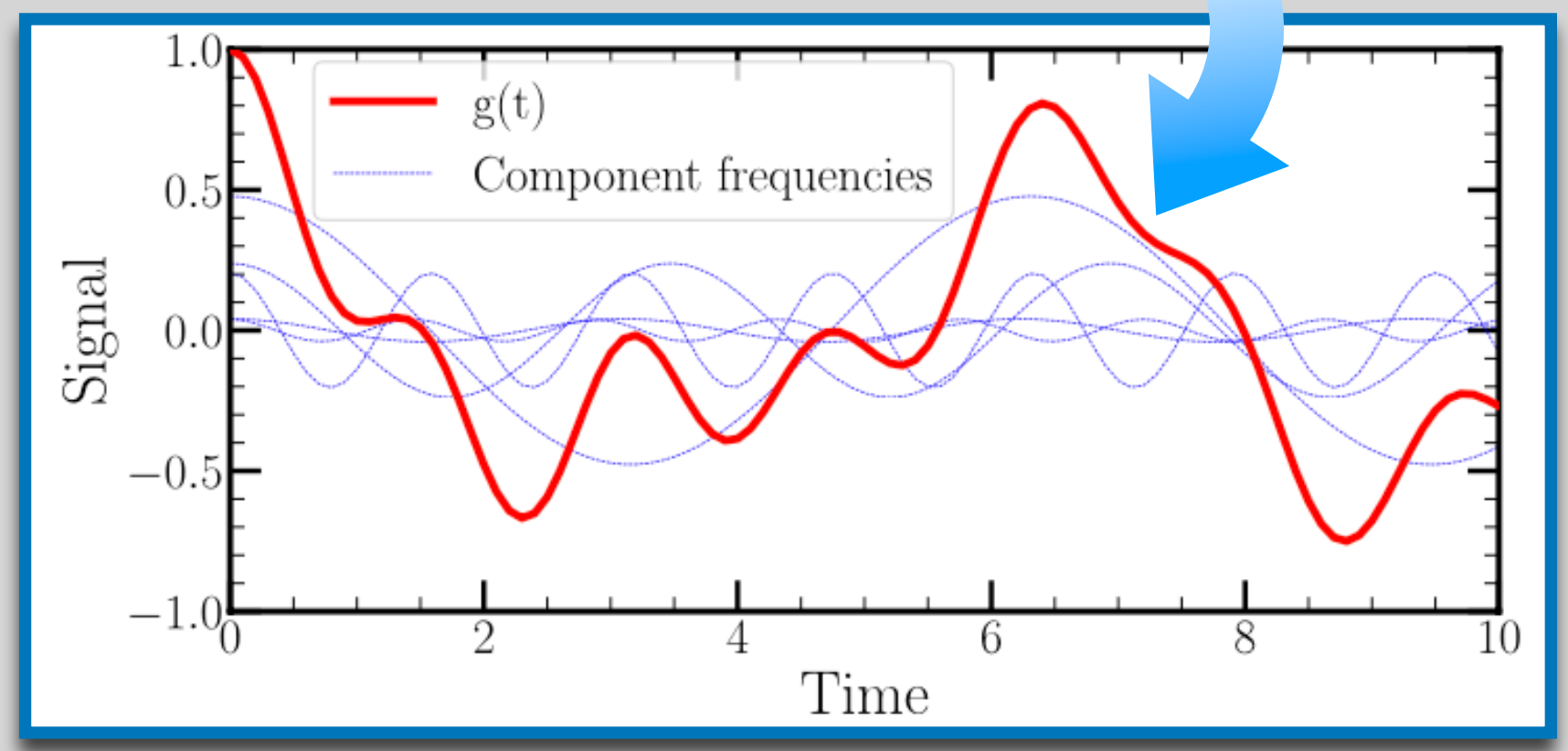

$$e^{-i\hat{H}t} = \sum_k e^{-iE_k t} |\psi_k\rangle\langle\psi_k|$$

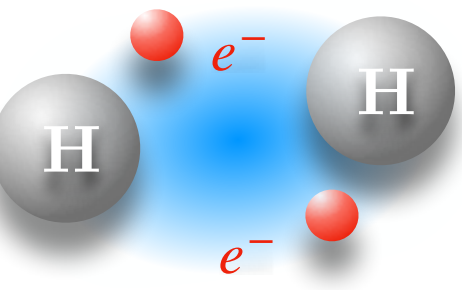

A

B

C

$$|0\rangle \otimes |\Psi_{\text{initial}}\rangle$$

$$\frac{1}{\sqrt{2}} (|0\rangle + |1\rangle) \otimes |\Psi_{\text{initial}}\rangle$$

$$\frac{1}{\sqrt{2}} \sum_k (|0\rangle + |1\rangle e^{-iE_k t}) \otimes C_k |\psi_k\rangle$$

$C_k = \langle\psi_k|\Psi_{\text{initial}}\rangle$

IV) Fault Tolerant Era: Quantum Phase Estimation

Ancillary Qubit

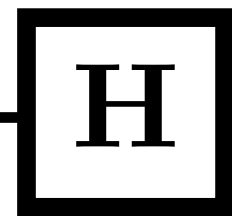

Measure

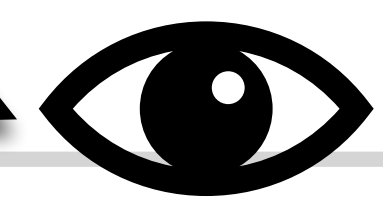
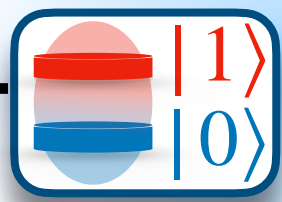

State Tomography

$$g = \sum_k |C_k|^2 e^{iE_k t}$$

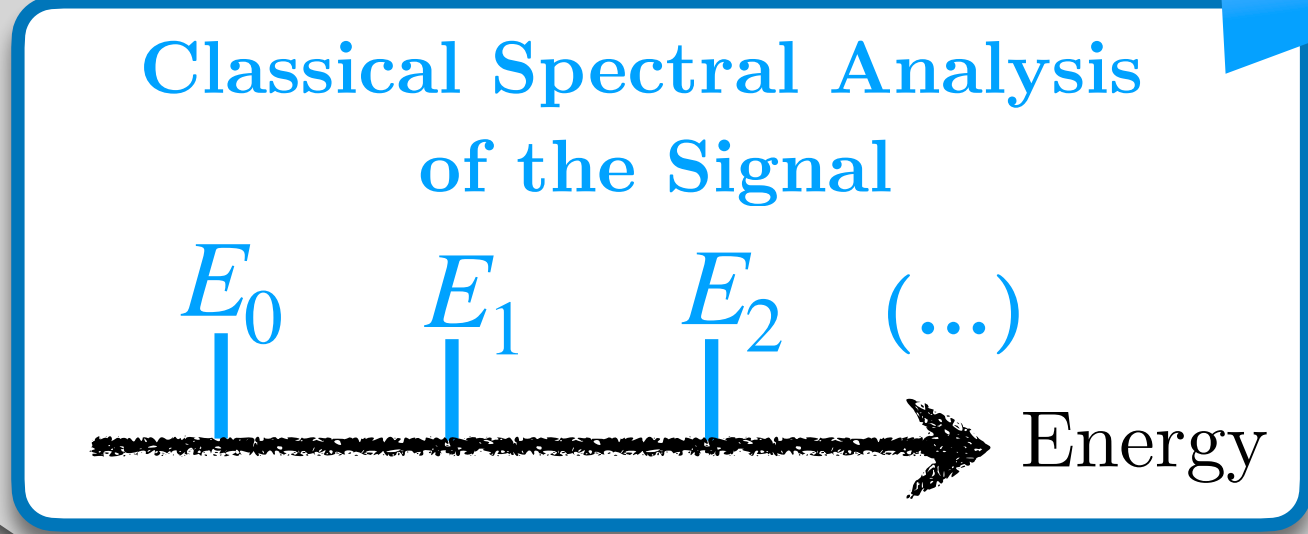
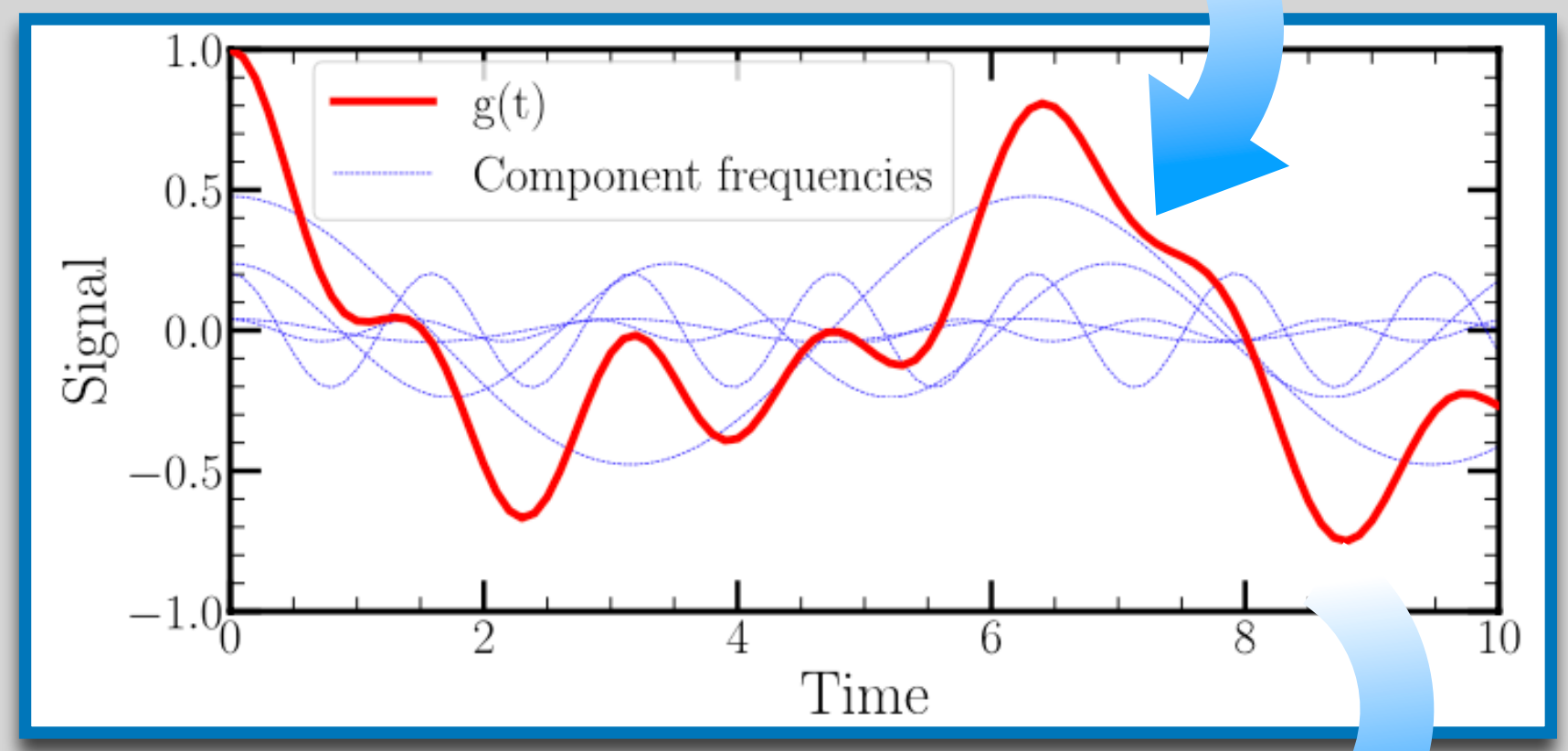

$$e^{-i\hat{H}t} = \sum_k e^{-iE_k t} |\psi_k\rangle\langle\psi_k|$$

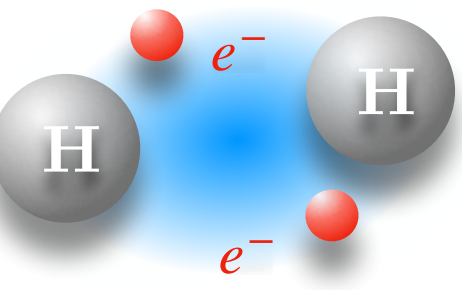

A

B

C

$$|0\rangle \otimes |\Psi_{\text{initial}}\rangle$$

$$\frac{1}{\sqrt{2}} (|0\rangle + |1\rangle) \otimes |\Psi_{\text{initial}}\rangle$$

$$\frac{1}{\sqrt{2}} \sum_k (|0\rangle + |1\rangle) e^{-iE_k t} \otimes C_k |\psi_k\rangle$$

$C_k = \langle\psi_k|\Psi_{\text{initial}}\rangle$

Conclusion

Conclusion

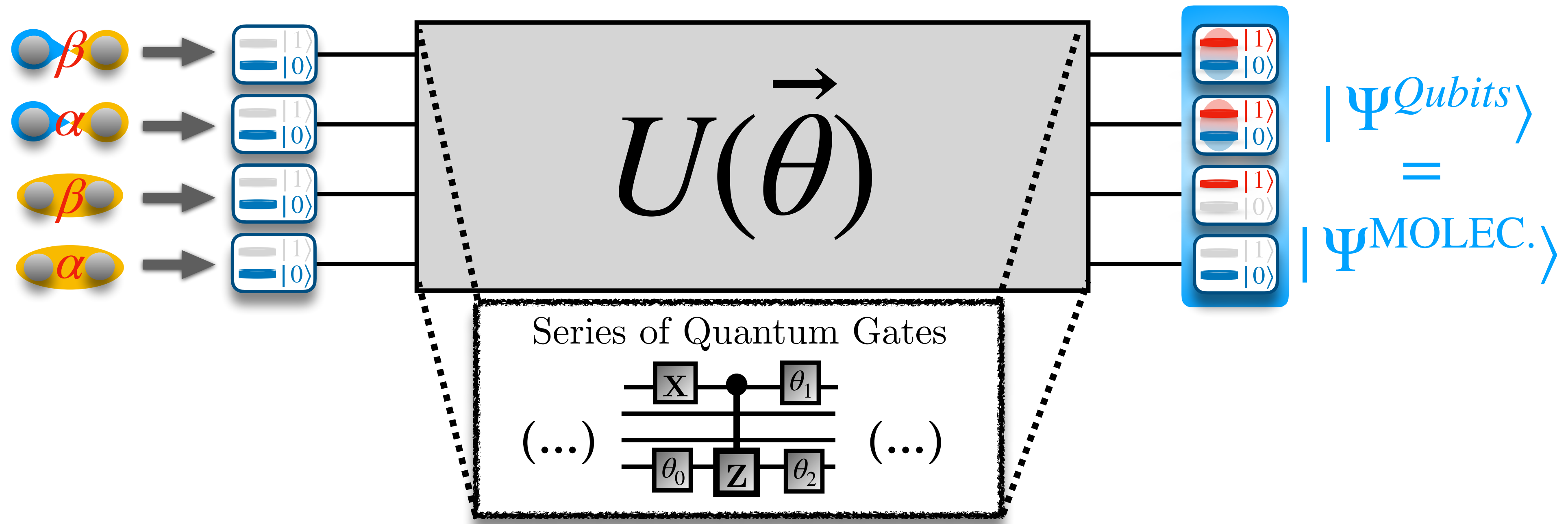

Conclusion

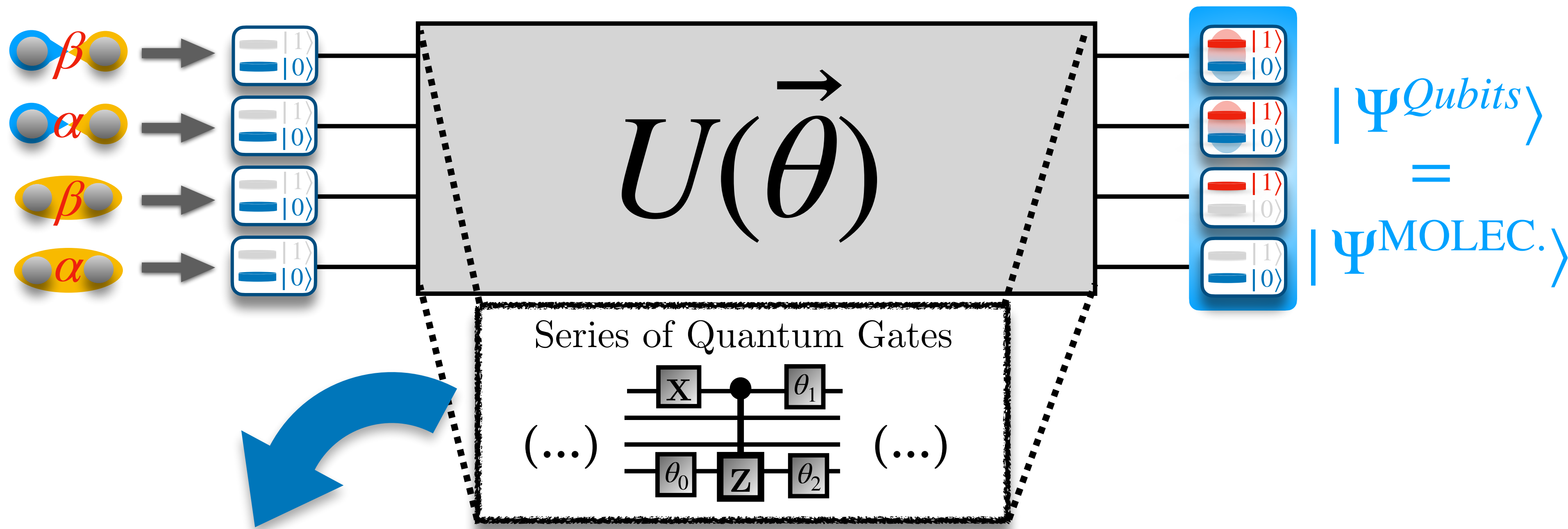

Near Term Era

Hardware Limitations

Variational Quantum Eigensolver

Conclusion

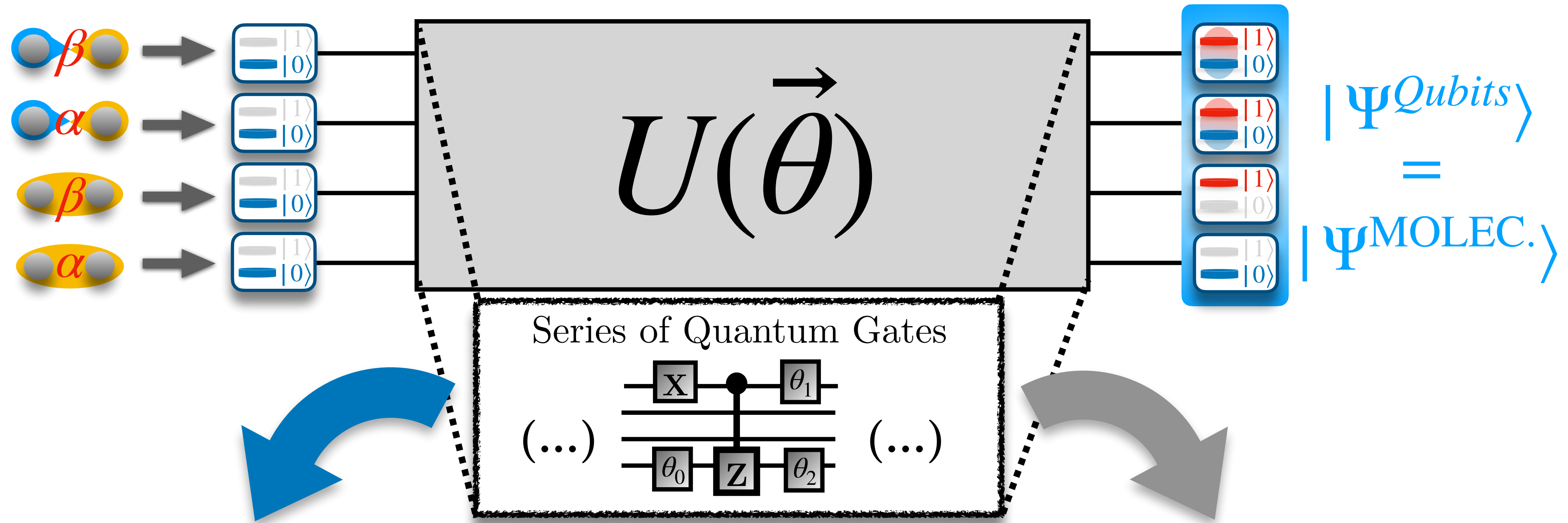

Near Term Era

Hardware Limitations

Variational Quantum Eigensolver

Fault Tolerant Era

No Hardware Limitations

Quantum Phase Estimation

Announcement

PhD and Postdoc Opportunities coming soon in 2025 !!

Quantum Algorithm for Quantum Chemistry

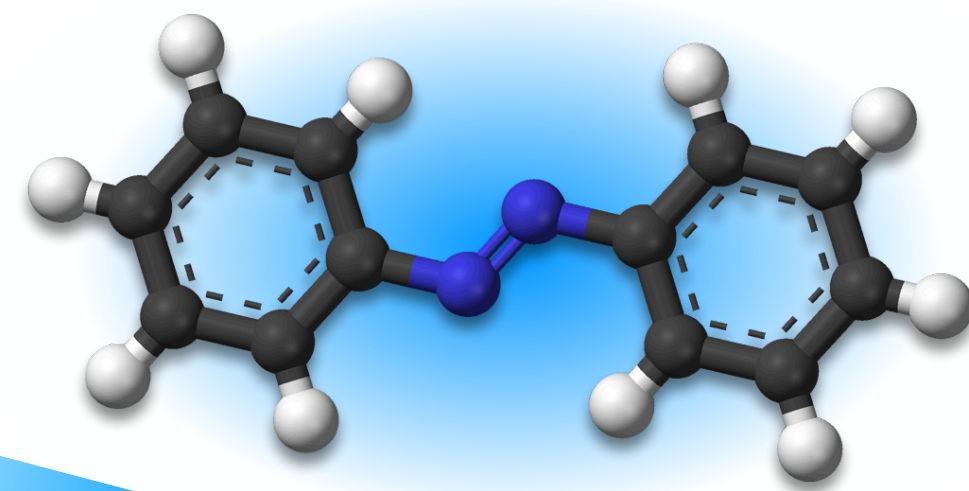
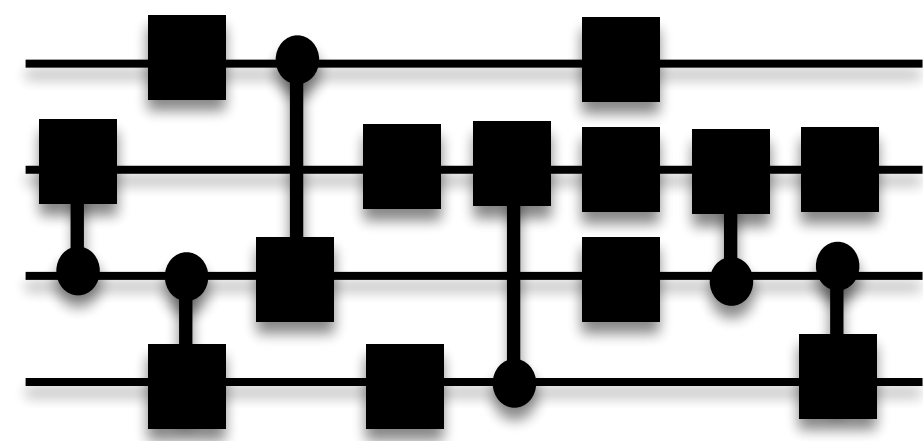

$$H\Psi_k = E_k\Psi_k$$

< LCQ | S >

Laboratoire de Chimie Quantique de Strasbourg

ICGM

Institut Charles Gerhardt Montpellier

LOMA
UMR5798

Laboratoire Ondes et Matière d'Aquitaine

Contact us:

syalouz@unistra.fr or yalouzaad@gmail.com

II) Electronic structure on a Quantum Computer

II) From quantum computing to chemistry

Jordan-Wigner Mapping

1-to-1 Physical Correspondance

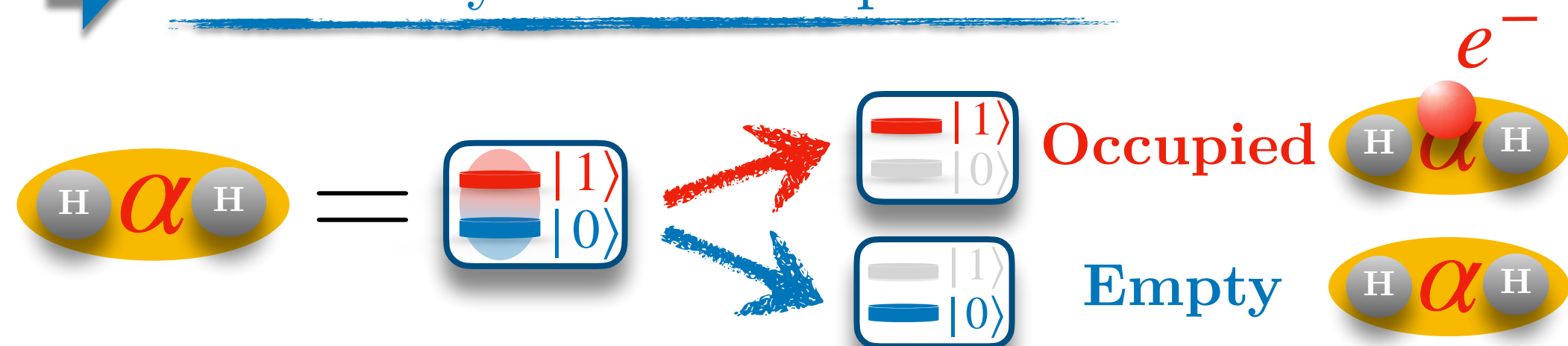

Translation of Fermionic Algebra

Pauli Operators

$$\begin{aligned}
 X &= |0\rangle\langle 1| + |1\rangle\langle 0| \\
 Y &= -i|0\rangle\langle 1| + i|1\rangle\langle 0| \\
 Z &= |0\rangle\langle 0| - |1\rangle\langle 1|
 \end{aligned}$$

$$a_p^\dagger = \frac{X_p - iY_p}{2} \bigotimes_{q=0}^{p-1} Z_q$$

Create 1 electron in the spinorbital "p"

Fermionic anti-symmetry



II) From quantum computing to chemistry

Jordan-Wigner Mapping

1-to-1 Physical Correspondance



Translation of Fermionic Algebra

Pauli Operators

$$\begin{aligned}
 X &= |0\rangle\langle 1| + |1\rangle\langle 0| \\
 Y &= -i|0\rangle\langle 1| + i|1\rangle\langle 0| \\
 Z &= |0\rangle\langle 0| - |1\rangle\langle 1|
 \end{aligned}$$

$$a_p^\dagger = \frac{X_p - iY_p}{2} \bigotimes_{q=0}^{p-1} Z_q$$

Create 1 electron in the spinorbital "p"

Fermionic anti-symmetry



II) From quantum computing to chemistry

Jordan-Wigner Mapping

1-to-1 Physical Correspondance



Translation of Fermionic Algebra

Pauli Operators

$$X = |0\rangle\langle 1| + |1\rangle\langle 0|$$

$$Y = -i|0\rangle\langle 1| + i|1\rangle\langle 0|$$

$$Z = |0\rangle\langle 0| - |1\rangle\langle 1|$$

$$a_p^\dagger = \frac{X_p - iY_p}{2} \bigotimes_{q=0}^{p-1} Z_q$$

Create 1 electron in the spinorbital "p"

Fermionic anti-symmetry

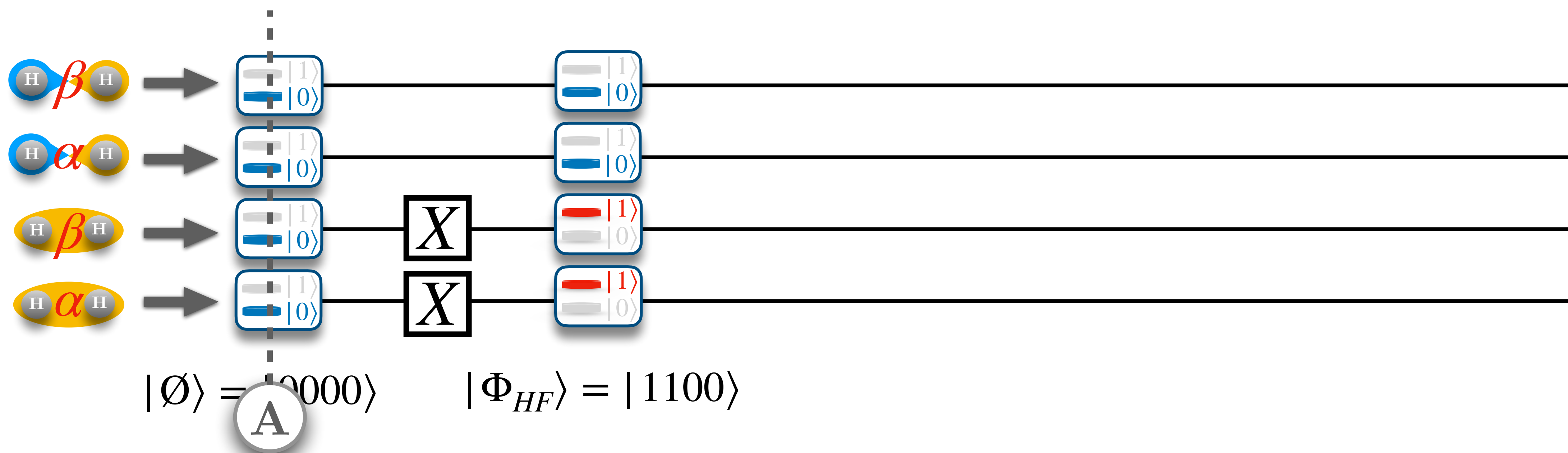

II) From quantum computing to chemistry

Jordan-Wigner Mapping

1-to-1 Physical Correspondance

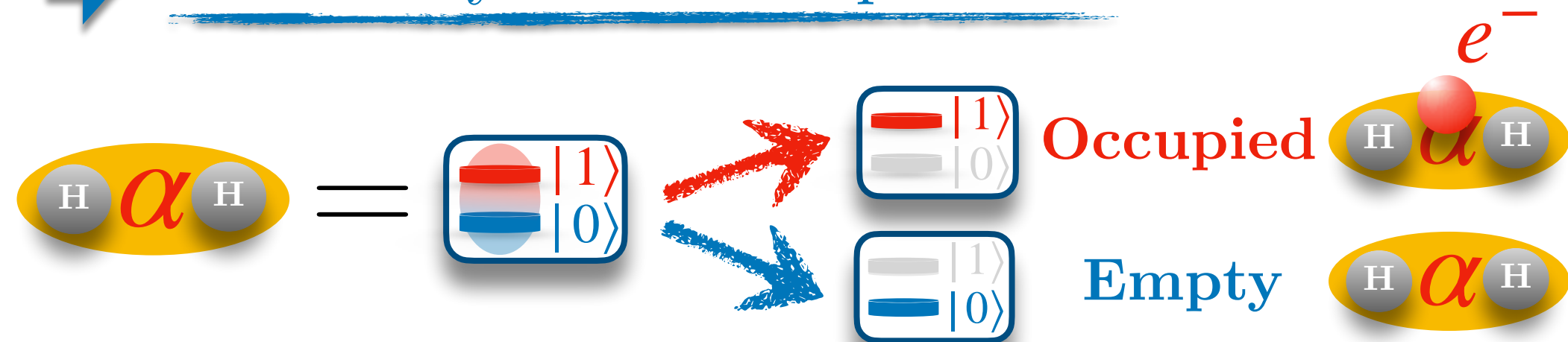

Translation of Fermionic Algebra

Pauli Operators

$$\begin{aligned}
 X &= |0\rangle\langle 1| + |1\rangle\langle 0| \\
 Y &= -i|0\rangle\langle 1| + i|1\rangle\langle 0| \\
 Z &= |0\rangle\langle 0| - |1\rangle\langle 1|
 \end{aligned}$$

$$a_p^\dagger = \frac{X_p - iY_p}{2} \bigotimes_{q=0}^{p-1} Z_q$$

Create 1 electron in the spinorbital "p"

Fermionic anti-symmetry

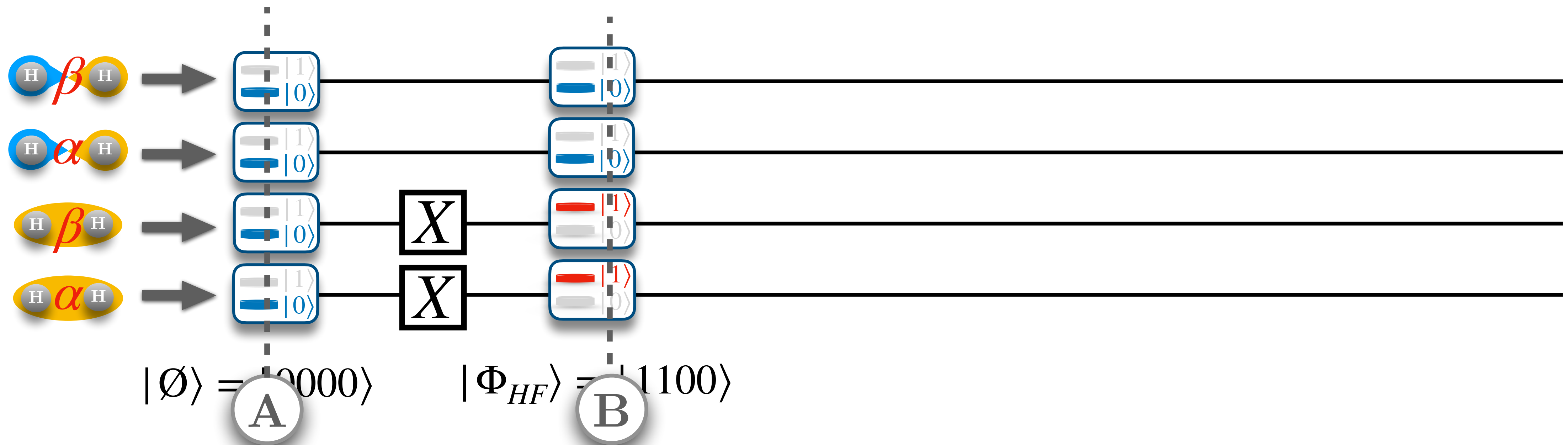

II) From quantum computing to chemistry

Jordan-Wigner Mapping

1-to-1 Physical Correspondance



Translation of Fermionic Algebra

Pauli Operators

$$X = |0\rangle\langle 1| + |1\rangle\langle 0|$$

$$Y = -i|0\rangle\langle 1| + i|1\rangle\langle 0|$$

$$Z = |0\rangle\langle 0| - |1\rangle\langle 1|$$

$$a_p^\dagger = \frac{X_p - iY_p}{2} \bigotimes_{q=0}^{p-1} Z_q$$

Create 1 electron in the spinorbital "p"

Fermionic anti-symmetry

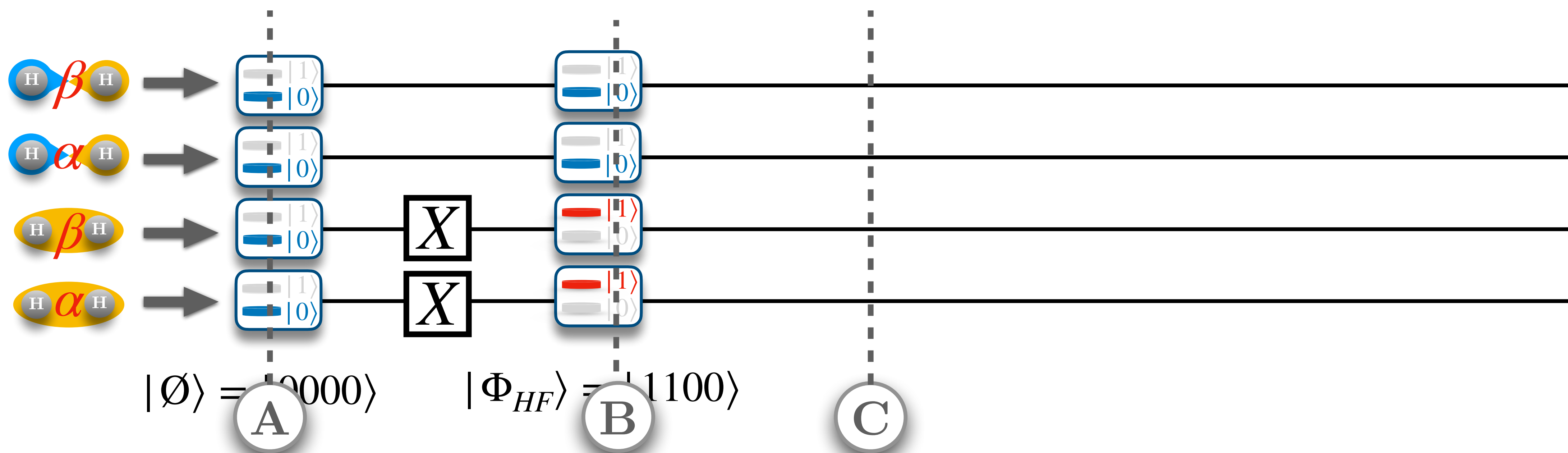

II) From quantum computing to chemistry

Jordan-Wigner Mapping

1-to-1 Physical Correspondance



Translation of Fermionic Algebra

Pauli Operators

$$X = |0\rangle\langle 1| + |1\rangle\langle 0|$$

$$Y = -i|0\rangle\langle 1| + i|1\rangle\langle 0|$$

$$Z = |0\rangle\langle 0| - |1\rangle\langle 1|$$

$$a_p^\dagger = \frac{X_p - iY_p}{2} \bigotimes_{q=0}^{p-1} Z_q$$

Create 1 electron in the spinorbital "p"

Fermionic anti-symmetry

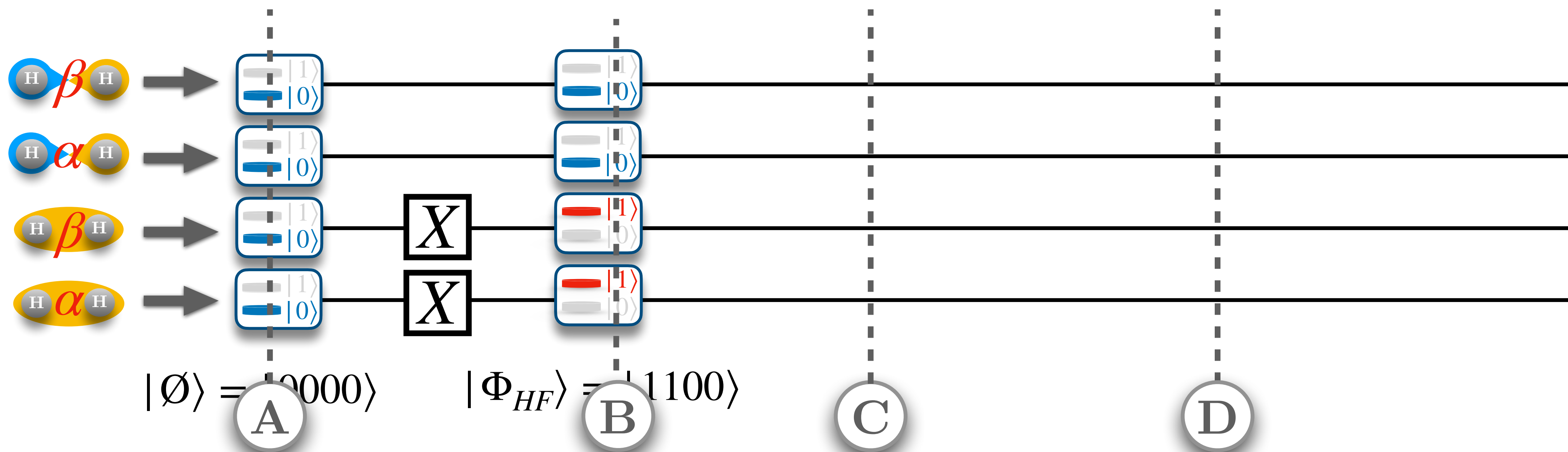

II) From quantum computing to chemistry

Electronic Structure Problem

$$H = \sum_{pq}^{N_o} h_{pq} \sum_{\sigma}^{\{\uparrow, \downarrow\}} \hat{a}_{p\sigma}^\dagger \hat{a}_{q\sigma} + \frac{1}{2} \sum_{pqrs}^{N_o} g_{pqrs} \sum_{\sigma, \tau}^{\{\uparrow, \downarrow\}} \hat{a}_{p\sigma}^\dagger \hat{a}_{r\tau}^\dagger \hat{a}_{s\tau} \hat{a}_{q\sigma} + E_{nuc}^{rep}$$

$$h_{pq} = \int \phi_p^*(\mathbf{r}_i) \left(-\frac{1}{2} \nabla_{\mathbf{r}_i}^2 - \sum_{A=1}^{N_a} \frac{Z_A}{|\mathbf{r}_i - \mathbf{R}_A|} \right) \phi_q(\mathbf{r}_i) d\mathbf{r}_i$$

$$g_{pqrs} = \iint \phi_p^*(\mathbf{r}_i) \phi_r^*(\mathbf{r}_j) \frac{1}{|\mathbf{r}_i - \mathbf{r}_j|} \phi_q(\mathbf{r}_i) \phi_s(\mathbf{r}_j) d\mathbf{r}_i d\mathbf{r}_j$$

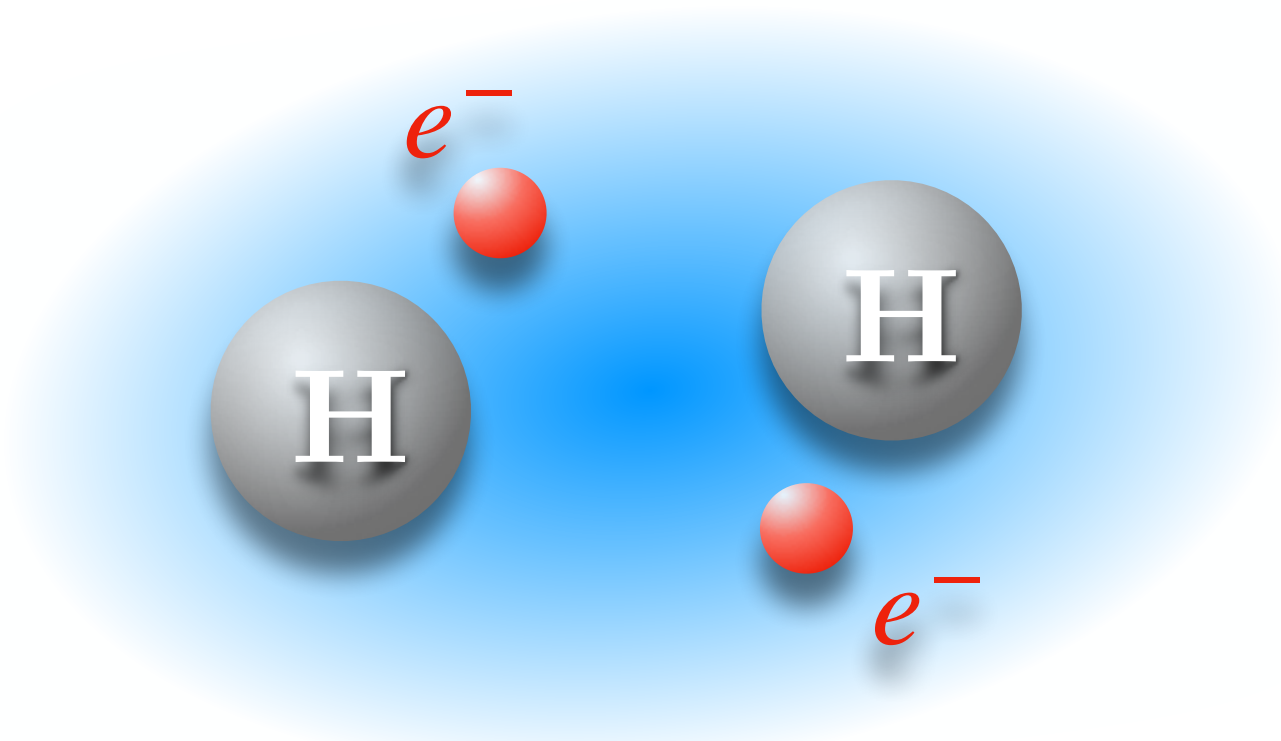

Resolution: *Mean-Field Approach*

Single Configuration Approximation $|\Psi_0\rangle \approx |\text{HF}\rangle$
Hartree-Fock calculation

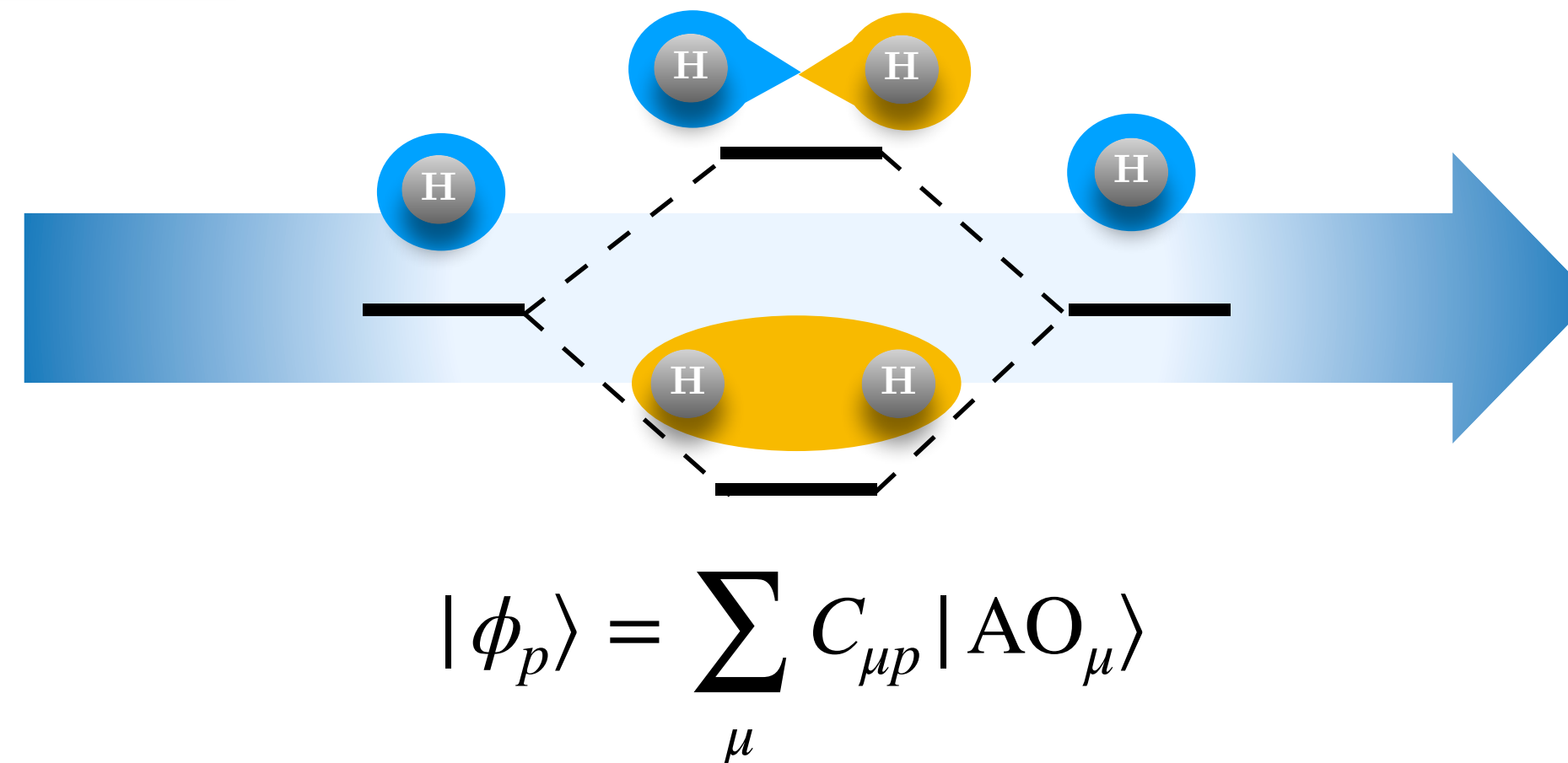

II) From quantum computing to chemistry

Electronic Structure Problem

$$H = \sum_{pq}^{N_o} h_{pq} \sum_{\sigma}^{\{\uparrow, \downarrow\}} \hat{a}_{p\sigma}^\dagger \hat{a}_{q\sigma} + \frac{1}{2} \sum_{pqrs}^{N_o} g_{pqrs} \sum_{\sigma, \tau}^{\{\uparrow, \downarrow\}} \hat{a}_{p\sigma}^\dagger \hat{a}_{r\tau}^\dagger \hat{a}_{s\tau} \hat{a}_{q\sigma} + E_{nuc}^{rep}$$

$$h_{pq} = \int \phi_p^*(\mathbf{r}_i) \left(-\frac{1}{2} \nabla_{\mathbf{r}_i}^2 - \sum_{A=1}^{N_a} \frac{Z_A}{|\mathbf{r}_i - \mathbf{R}_A|} \right) \phi_q(\mathbf{r}_i) d\mathbf{r}_i$$

$$g_{pqrs} = \iint \phi_p^*(\mathbf{r}_i) \phi_r^*(\mathbf{r}_j) \frac{1}{|\mathbf{r}_i - \mathbf{r}_j|} \phi_q(\mathbf{r}_i) \phi_s(\mathbf{r}_j) d\mathbf{r}_i d\mathbf{r}_j$$

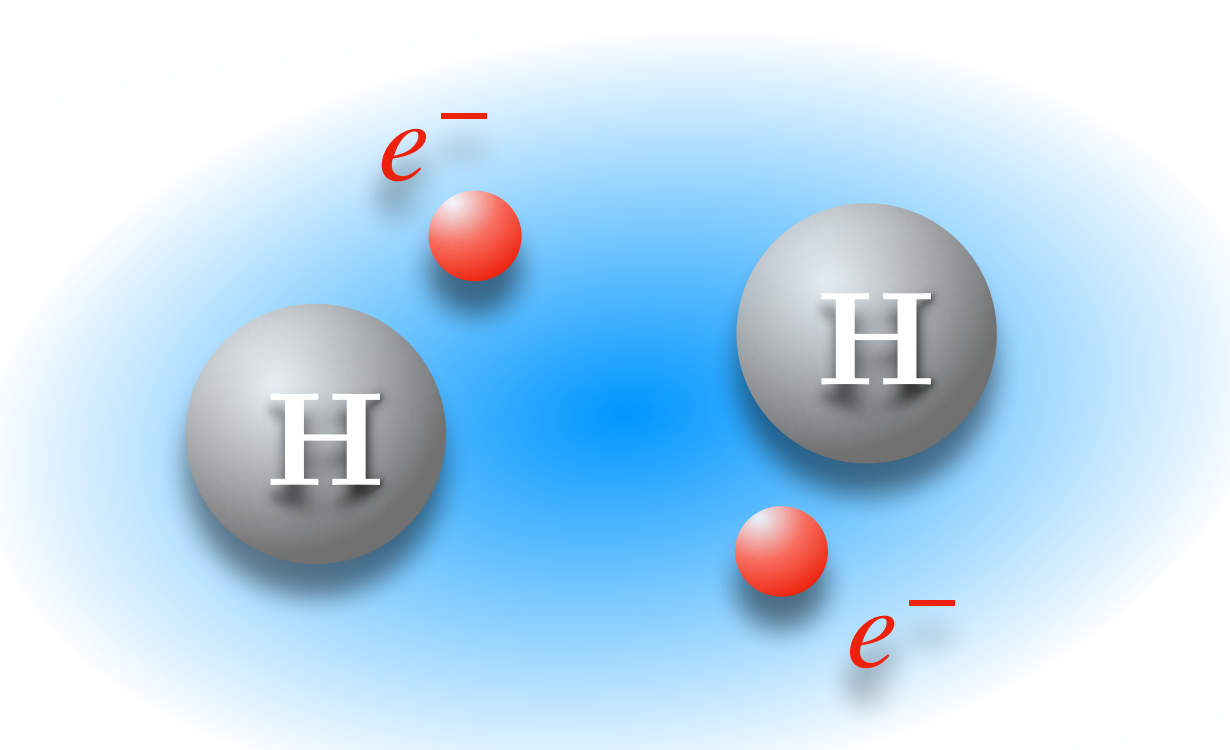

Resolution: *Mean-Field Approach*

Single Configuration Approximation $|\Psi_0\rangle \approx |\text{HF}\rangle$

Hartree-Fock calculation

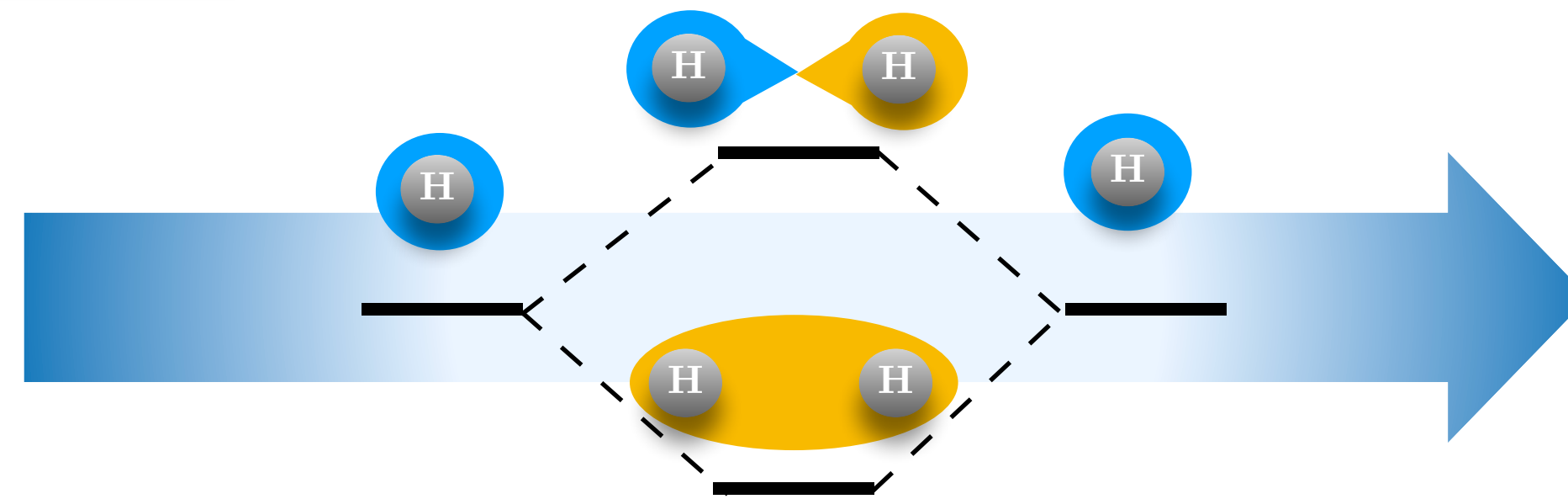

$$|\phi_p\rangle = \sum_{\mu} C_{\mu p} |\text{AO}_{\mu}\rangle$$

II) From quantum computing to chemistry

Electronic Structure Problem

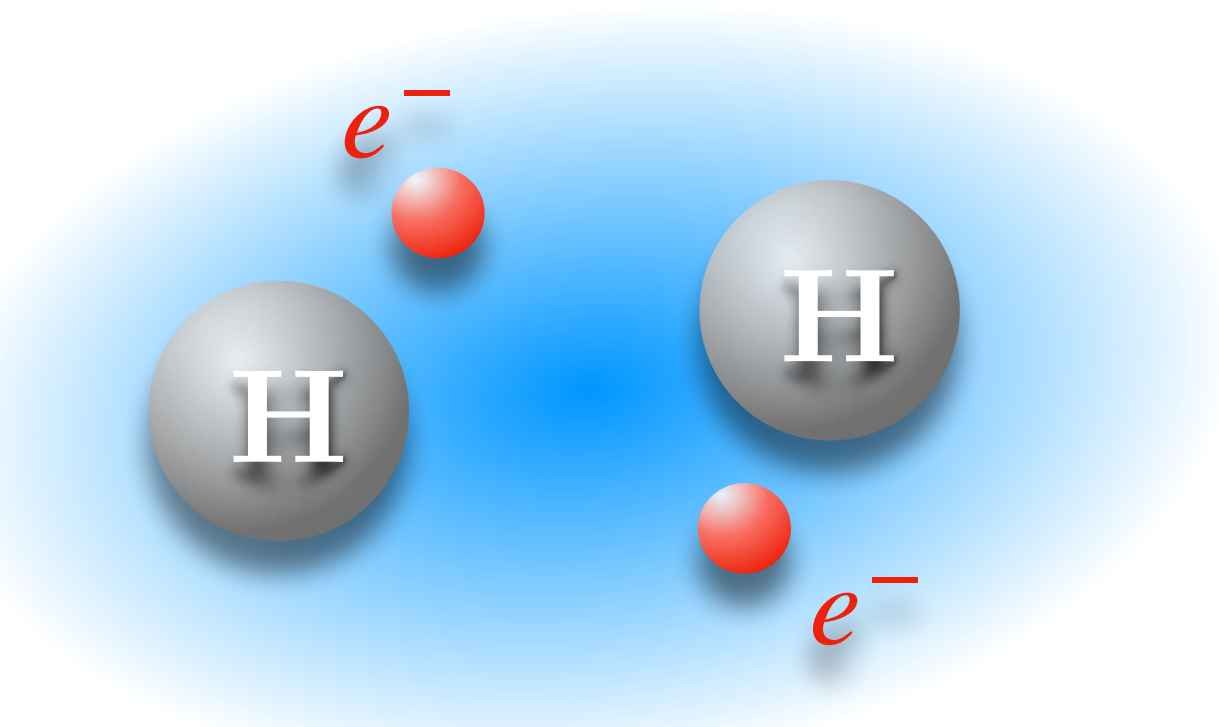

$$H = \sum_{pq}^{N_o} h_{pq} \sum_{\sigma}^{\{\uparrow, \downarrow\}} \hat{a}_{p\sigma}^\dagger \hat{a}_{q\sigma} + \frac{1}{2} \sum_{pqrs}^{N_o} g_{pqrs} \sum_{\sigma, \tau}^{\{\uparrow, \downarrow\}} \hat{a}_{p\sigma}^\dagger \hat{a}_{r\tau}^\dagger \hat{a}_{s\tau} \hat{a}_{q\sigma} + E_{nuc}^{rep}$$

$$h_{pq} = \int \phi_p^*(\mathbf{r}_i) \left(-\frac{1}{2} \nabla_{\mathbf{r}_i}^2 - \sum_{A=1}^{N_a} \frac{Z_A}{|\mathbf{r}_i - \mathbf{R}_A|} \right) \phi_q(\mathbf{r}_i) d\mathbf{r}_i$$

$$g_{pqrs} = \iint \phi_p^*(\mathbf{r}_i) \phi_r^*(\mathbf{r}_j) \frac{1}{|\mathbf{r}_i - \mathbf{r}_j|} \phi_q(\mathbf{r}_i) \phi_s(\mathbf{r}_j) d\mathbf{r}_i d\mathbf{r}_j$$

Resolution: Mean-Field Approach

Single Configuration Approximation $|\Psi_0\rangle \approx |\text{HF}\rangle$

Hartree-Fock calculation

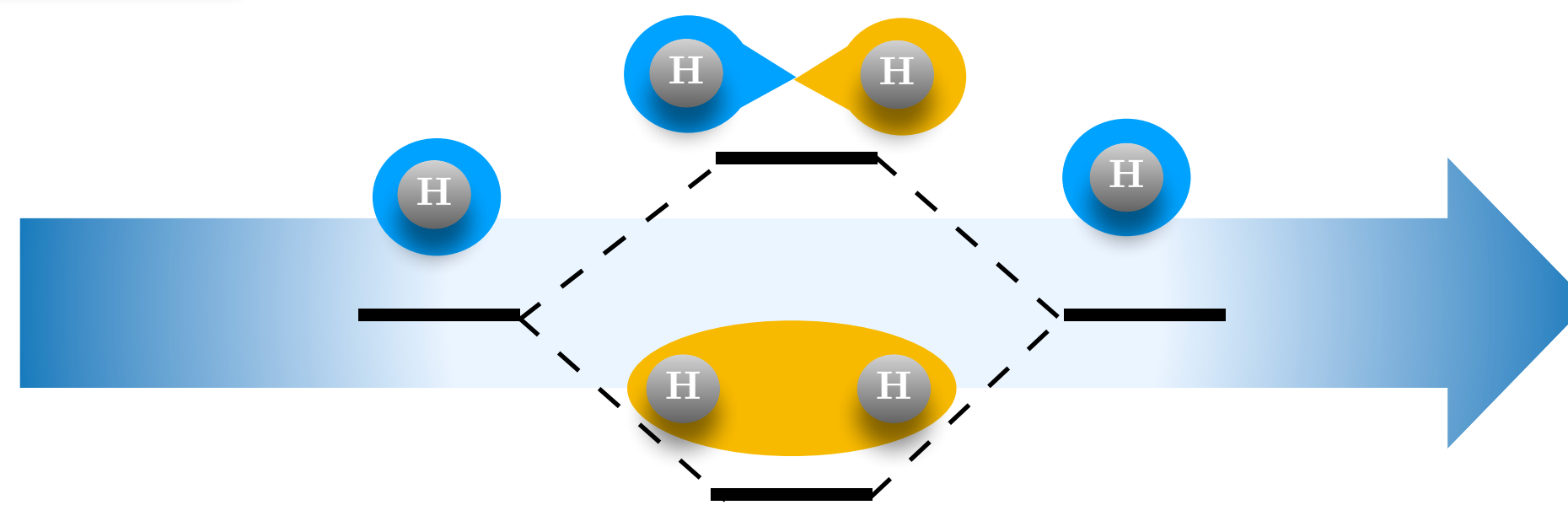

$$|\phi_p\rangle = \sum_{\mu} C_{\mu p} |\text{AO}_{\mu}\rangle$$

Spin-Orbitals

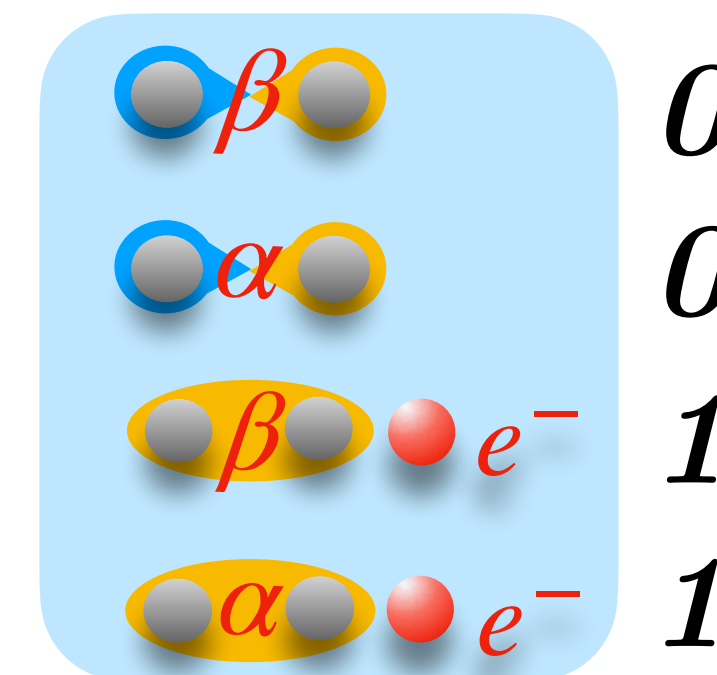

$$|\text{HF}\rangle = |1100\rangle$$

II) From quantum computing to chemistry

Electronic Structure Problem

$$H = \sum_{pq}^{N_o} h_{pq} \sum_{\sigma}^{\{\uparrow, \downarrow\}} \hat{a}_{p\sigma}^\dagger \hat{a}_{q\sigma} + \frac{1}{2} \sum_{pqrs}^{N_o} g_{pqrs} \sum_{\sigma, \tau}^{\{\uparrow, \downarrow\}} \hat{a}_{p\sigma}^\dagger \hat{a}_{r\tau}^\dagger \hat{a}_{s\tau} \hat{a}_{q\sigma} + E_{nuc}^{rep}$$

$$h_{pq} = \int \phi_p^*(\mathbf{r}_i) \left(-\frac{1}{2} \nabla_{\mathbf{r}_i}^2 - \sum_{A=1}^{N_a} \frac{Z_A}{|\mathbf{r}_i - \mathbf{R}_A|} \right) \phi_q(\mathbf{r}_i) d\mathbf{r}_i$$

$$g_{pqrs} = \iint \phi_p^*(\mathbf{r}_i) \phi_r^*(\mathbf{r}_j) \frac{1}{|\mathbf{r}_i - \mathbf{r}_j|} \phi_q(\mathbf{r}_i) \phi_s(\mathbf{r}_j) d\mathbf{r}_i d\mathbf{r}_j$$

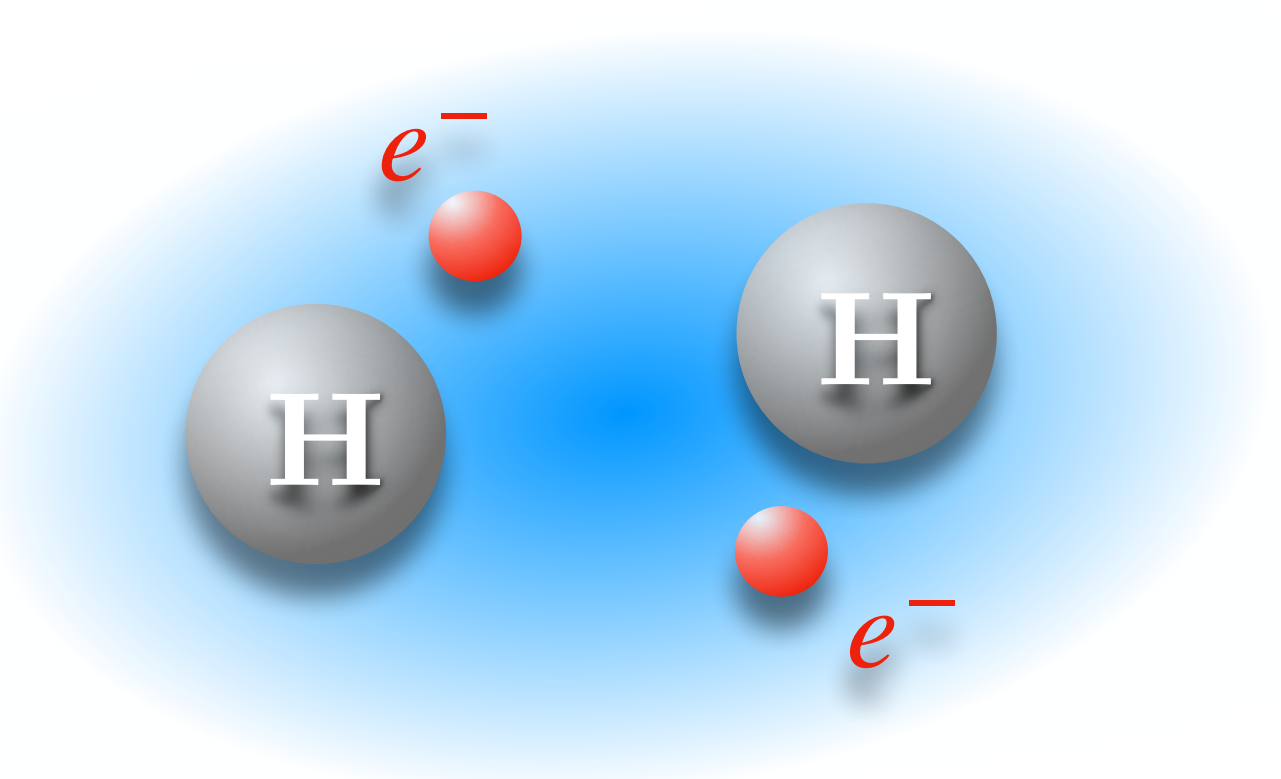

Resolution: Mean-Field Approach

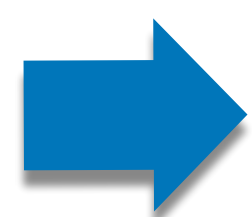

$$H|\Psi_0\rangle = E_0|\Psi_0\rangle$$

Single Configuration Approximation $|\Psi_0\rangle \approx |\text{HF}\rangle$

Hartree-Fock calculation

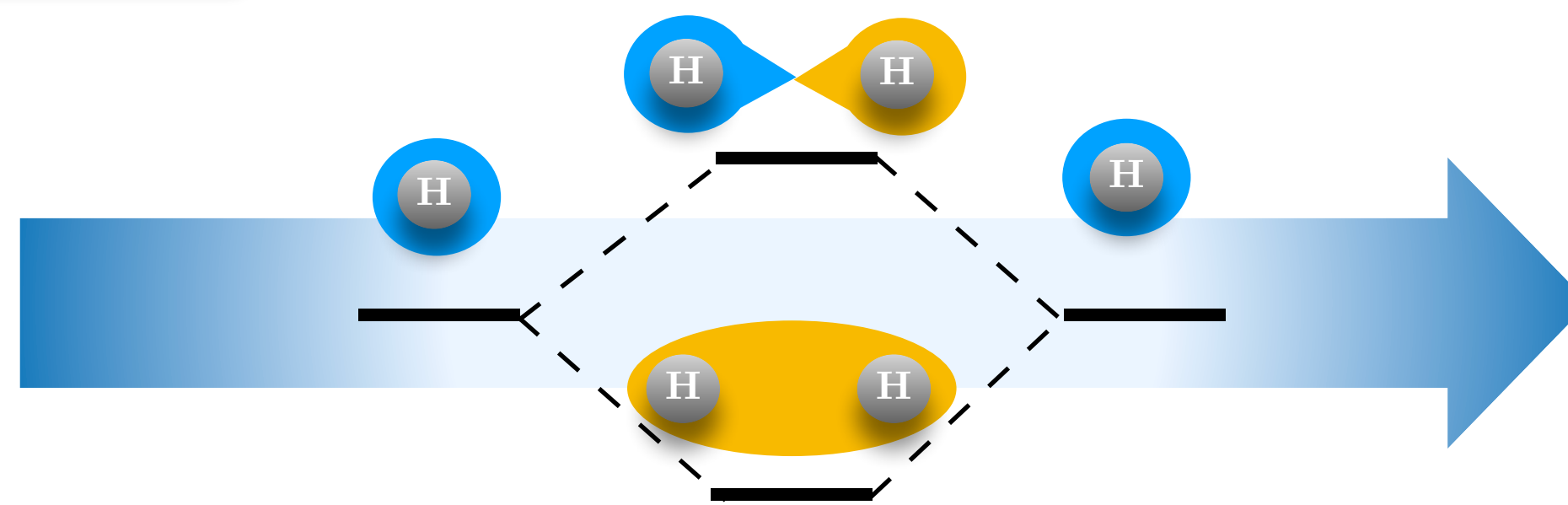

$$|\phi_p\rangle = \sum_{\mu} C_{\mu p} |\text{AO}_{\mu}\rangle$$

Spin-Orbitals

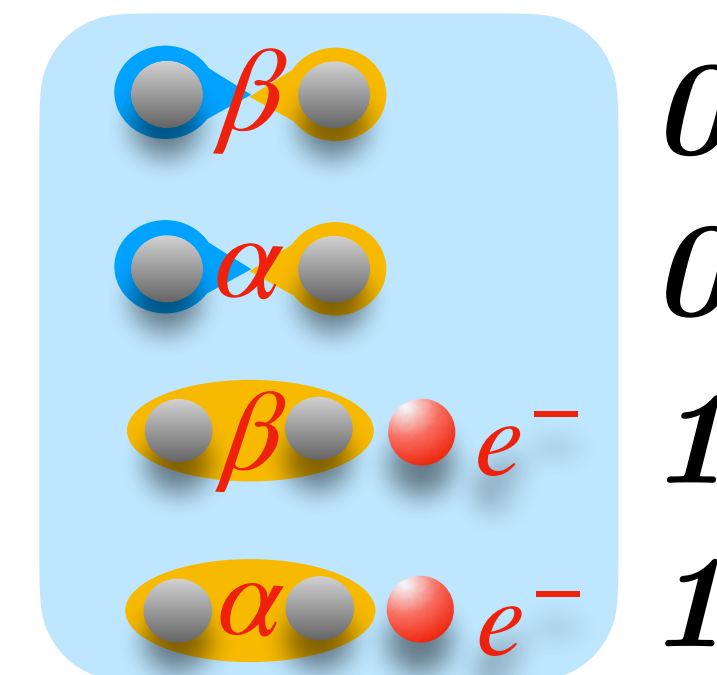

$$|\text{HF}\rangle = |1100\rangle$$